

Beechcraft[®]

Baron[®]

(Serials TH-773 thru TH-1395, except TH-1389)

58
And
58A*

** Special Reduced Gross Weight Configuration*

Pilot's Operating Handbook and FAA Approved Airplane Flight Manual

FAA Approved in the Normal Category based on CAR 3. This document must be carried in the airplane at all times and be kept within reach of the pilot during all flight operations.

This handbook includes the material required to be furnished to the pilot by CAR 3.

Airplane Serial Number: _____

Airplane Registration Number: _____

FAA Approved: _____

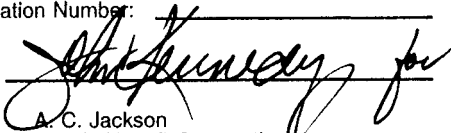
A. C. Jackson
Beech Aircraft Corporation
DOA CE-2

Exported under the authority of license exception: TSU.
"These commodities, technology or software were exported from the United States in accordance with Export Administration Regulations. Diversion contrary to U.S. law prohibited."

COPYRIGHT © BEECH 1994

P/N 58-590000-21
Issued: October, 1976

P/N 58-590000-21A13
Revised: July, 1994

Published By
RAYTHEON AIRCRAFT COMPANY
P.O. Box 85
Wichita, Kansas 67201
U.S.A.

NOTE

Where Beech Aircraft Corporation or Beechcraft is referred to in this publication, it will be taken to read Raytheon Aircraft Company.

Exported under the authority of license exception: TSU.
"These commodities, technology or software were exported from the United States in accordance with Export Administration Regulations. Diversion contrary to U.S. law prohibited."

Raytheon Aircraft

Beech
Hawker



Member of GAMA
General Aviation
GAMA Manufacturers Association

Raytheon Aircraft

Baron 58 and 58A

Log of Temporary Changes

to the

Pilot's Operating Handbook

and

FAA Approved Airplane Flight Manual

P/N 58-590000-21

Temporary Changes to this Pilot's Operating Handbook and FAA Approved Airplane Flight Manual must be in the airplane for all flight operations.

Part Number	Subject	Date
58-590000-21TC1	Fuel Selector Placard Installation (affects Limitations section)	10/21/97

Note: This page shall be filed in the front of the *Pilot's Operating Handbook and FAA Approved Airplane Flight Manual* immediately in front of the latest *Log of Revisions* page(s). This page replaces any *Log of Temporary Changes* page dated prior to the date in the lower left corner of this page.

**BARON 58 AND 58A
(TH-773 THRU TH-1395, EXCEPT TH-1389)
PILOT'S OPERATING HANDBOOK
AND**

FAA APPROVED AIRPLANE FLIGHT MANUAL

A13 Revision July, 1994

LOG OF REVISIONS

Page	Description
Title Page	Updated
Page A (A13)	New
10-1 thru 10-64	Revised Section X, Safety Information (May, 1994)

A13

**BARON 58 AND 58A
 (TH-773 THRU TH-1395 EXCEPT TH-1389)
 PILOT'S OPERATING HANDBOOK
 AND
 FAA APPROVED AIRPLANE FLIGHT MANUAL**

A12 Revision October, 1990

LOG OF REVISIONS

Page	Description
Title Page	Updated
Page A (A12)	New
10-1 thru 10-68	Revised Section X, Safety Information (October, 1990)
	A12

Baron 58/58A
(TH-773 thru TH-1395, except TH-1389)
Pilot's Operating Handbook
and
FAA Approved Airplane Flight Manual
Log of Revisions
P/N 58-590000-21A11

A11 March, 1988

Page	Description
Title Page	Updated
Page A (A11)	New
2-10	Revised: "KINDS OF OPERATION" and "WARNING"
4-21	Revised: "ICE PROTECTION SYSTEMS"
8-48	Revised: "OVERHAUL OR REPLACEMENT SCHEDULE"

A11

Baron 58/58A
(TH-773 thru TH-1395, except TH-1389)
Pilot's Operating Handbook
and
FAA Approved Airplane Flight Manual
Log of Revisions

A10 August, 1984

Page	Description
Title Page	Update
Page A(A10)	Added
Page B (A10)	Added
1-4A and 1-4B	Revised: "Important Notice"
1-10	Revised: "Propellers"
2-2	Revised: "Table of Contents"
2-6	Revised: "Propellers"
2-10 and 2-11	Shifted Material; Relocated Page 2-20 to Pages 2-10 and 2-11, and Revised: "Oxygen Requirements"
2-12 thru 2-23	Relocated: "Placards" from Pages 2-21 thru 2-32 to Pages 2-12 thru 2-23
2-24 thru 2-30	Revised: "Required Equipment for Various Conditions of Flight" title to "Kinds of Operations Equipment List"; Revised: System and/or Component List of Same; Relocated: Same from Pages 2-10 thru 2-19 to Pages 2-24 thru 2-30.
2-31 and 2-32	Deleted
3-1	Revised: "Table of Contents"
3-6 and 3-7	Revised: "Air Start", and Shifted Material
3-11	Added: Serialization to "Illumination of Alternator-Out Light"
3-12, 3-12A, and 3-12B	Added: "Illumination of Alternator-Out Light (TH-1377 and after, and Airplanes Equipped With Kit No. 55-3024)"; Shifted Material; and Added: "Intentionally Left Blank Page"
4-1	Revised: "Table of Contents"
4-4, 4-4A, 4-4B, 4-5, and 4-6	Revised: "Preflight Inspection"; Shifted Material; Added "Intentionally Left Blank Page"
4-9 and 4-10	Revised: "Before Takeoff"
4-15	Revised: "Oxygen Duration Graph"
7-2 and 7-3	Revised: "Table of Contents"
7-10 and 7-11	Revised: "Control Switch"; Shifted Material
7-28	Added: Serialization to "Alternators"
7-30 and 7-31	Added: "Alternators (TH-1377 and after, and Airplanes Equipped With Kit No. 55-3024)"; Revised: "External Power"; Shifted Material

A10

LOG OF REVISIONS

Page	Description
7-43 and 7-44	Revised: "Engine Break-In Information"; Shifted Material
8-1 and 8-2	Revised: "Table of Contents"
8-6, 8-6A, and 8-6B	Revised: "Publications" and Shifted Material
8-7	Revised: "Alterations to Airplane"
8-13 and 8-14	Deleted: "Recharging the Battery" and Shifted Material
8-16 thru 8-18	Revised: "Oil System", "Battery", and "Tires"; Shifted Material

A10

**Baron 58/58A (TH-773 Through TH-1395 ,
Except TH-1389)
Pilot's Operating Handbook
and
FAA Approved Airplane Flight Manual**

A9April, 1984

LOG OF REVISIONS

Page	Description
Title Page Page A (A9)	Update New

98-38307

A9

Baron 58 (TH-773 and After)
Pilot's Operating Handbook
and
FAA Approved Airplane Flight Manual

A8 March 1983

LOG OF REVISIONS

PAGES	DESCRIPTION
Title Page	Update
Page A (A8)	New
a & b	Revise "Introduction" and Add "Warning"
1-4, 1-4A, 1-4B, 1-5 & 1-6	Revise "NOTE" and Shift Material
2-27 & 2-28	Revise "Placards"
3-1 & 3-2	Update Table of Contents
3-3 & 3-4	Revise "Emergency Airspeeds", Add Stall Warning Horn Advisory and Shift Material
3-9	Revise "One Engine Inoperative Landing"
3-16 & 3-17	Revise "Emergency Exits"
4-1	Update Table of Contents
4-3	Revise "Airspeeds For Safe Operation"
4-8A & 4-8B	Revise "Starting" and "After Starting and Taxi" and Shift Material
4-13	Revise "Balked Landing"
5-27	Revise "Climb-Two Engine (3-Blade Pro- peller)" Graph
7-2	Update Table of Contents
7-17 & 7-18	Revise "Openable Cabin Windows"
7-18A	Add "Emergency Exits"
8-2	Update Table of Contents
8-23	Revise "Heating and Ventilating System"
8-25, 8-26, 8-26A & 8-26B	Revise "Cleaning - Exterior Painted Surfaces" and Shift Material
8-31	Revise "Lubrication Points"
8-36	Revise "Recommended Servicing Schedule"
8-41, 8-42, 8-42A, 8-42B & 8-43	Revise "Consumable Materials"

A8

**Baron 58 (TH773 and After)
Pilot's Operating Handbook
and
FAA Approved Airplane Flight Manual**

A7 September, 1981

LOG OF REVISIONS

Page	Description
Title Page	Added Revision Date
Page A (A7)	New
7-2	Revised "Table of Contents"
7-3	Revised "Table of Contents"
7-28	Revised "Alternators"
7-31	Shifted Material
7-32	Revised "Interior Lighting"
7-32A	Added Page, Revised "Exterior Lighting"
7-32B	Added Page
7-33	Shifted Material

A7

**Baron 58 (TH-773 and After)
Pilot's Operating Handbook
and
FAA Approved Airplane Flight Manual**

A6 February, 1981

LOG OF REVISIONS

Page	Description
Title Page Logo Page	Added Revision Date Added
A Page (A6)	Update
7-32	Revised "Cabin Heating"
7-33	Revised "Environmental Schematic"
7-34	Revised "Heater Operation"
7-35	Revised "Heat Regulation"
7-36	Revised "Cabin Ventilation"
<div style="border: 2px solid black; padding: 10px; width: fit-content; margin: 0 auto;"> <p>10-1 Thru 10-67 Revised Safety Section Dated March 1981.</p> </div>	
98-38307	A6

BARON 58 (TH-773 and After)**Pilot's Operating Handbook****and****FAA Approved Airplane Flight Manual**

A5 September, 1980

LOG OF REVISIONS

Page	Description
Title Page	Add Revision Date
Page A (A5)	Update
1-5	Revised "Use of Handbook"
1-6	Shifted Material
1-9	Revised "Engines"
1-12	Revised "Airspeed Terminology"
1-16	Revised "Power Terminology"
2-1	Revised "Table of Contents"
2-5	Revised "Engines"
2-7	Revised "Power Plant Instrument Markings"
2-8	Shifted Material
2-11	Revised "Required Equipment for Various Conditions of Flight"
2-12	Revised "Electrical Power"
2-30 and 2-31	Revised "Placards"
3-1	Revised "Table of Contents"
3-11	Added "Starter Energized Warning Light Illuminated"
3-12 and 3-13	Shifted Material
4-7	Revised "Before Starting"
4-8 and 4-8A	Revised "Starting"
4-9 and 4-10	Revised "Before Take-Off"
4-10A	Revised "Maximum Normal Operating Power"
4-21	Revised "Ice Protection System"
4-27	Revised "Noise Characteristics"
5-29	Revised "Time, Fuel and Distance to Climb" Graph
5-33	Revised "Fuel Flow" vs "Horsepower"
6-9	Revised "Seating, Baggage and Equipment Arrangement"

98-38307

A5

LOG OF REVISIONS

Page	Description
7-2	Revised "Table of Contents"
7-13	Revised "Aft Baggage/Cargo Compartment"
7-17	Revised "Utility Door"
7-21 and 7-22	Shifted Material
7-22A	Revised "Fuel Flow and Pressure Indicator"
7-22B	Revised "Fuel Flow and Pressure Indicator" and Added "Fuel Flow Indicator"
7-23	Added "Fuel Flow Indicator"
7-27	Shifted Material
7-28	Revised "Battery" and "Alternator"
7-29	Revised "Power Distribution Schematic"
7-30	Revised "Alternator" and "Starters"
7-31	Revised "Starters"
7-32	Shifted Material
	A5

Baron 58 / 58A
PILOT'S OPERATING HANDBOOK
 and
FAA APPROVED AIRPLANE FLIGHT MANUAL
LOG OF REVISIONS

A4 September, 1979

Page	Description
Title Page	Add Revision Date and Letter
Page A (A4)	Update
Page B (A4)	Update
a	Revise "Introduction"
1-1	Revise "Table of Contents"
1-4	Revise "Important Notice"
1-5	Revise "Use of the Handbook"
1-6	Revise "Supplements Revision Record" and Add "Vendor-Issued STC Supplements"
1-9	Revise "Engines"
1-10	Revise "Propellers" and "Fuel"
1-16	Revise "Power Terminology"
1-17 thru 1-20	Shifted Material
2-1 and 2-2	Revise "Table of Contents"
2-3	Revise "Airspeed Limitations"
2-4	Revise "Airspeed Indicator Markings"
2-5	Revise "Engines" and "Fuel"
2-6	Revise "Propellers"
2-7	Revise "Tachometer"
2-10	Revise "Flight Load Factors" and "Required Equipment for Various Conditions of Flight"
2-12	Revise "Electrical Power"
2-16	Revise "Lights"
2-18	Revise "Engine Indicating Instruments"
2-21 thru 2-32	Revise "Placards" and Shifted Material
4-1 and 4-2	Revise "Table of Contents"
4-3	Revise "Speeds for Safe Operation"
4-5 and 4-6	Revise "Preflight Inspection"
4-7	Revise "Before Starting"
4-8 and 4-8A	Revise "Starting" and Shifted Material
4-10	Revise "Maximum Performance Climb"
4-10A	Add "Normal Operating Power Climb"
4-11 and 4-12	Shifted Material
4-22A	Shifted Material
4-23	Add "Windshield Anti-ice System (Electro- thermal)"
4-24 and 4-25	Shifted Material
4-26 and 4-27	Add "Noise Characteristics"
5-1 and 5-2	Revise "Table of Contents"

98-38307

A4

LOG OF REVISIONS

Page	Description
5-13	Revise "Comments Pertinent to the Use of Performance Graphs"
5-26A	Revise "Climb-Two Engine (TH-773 thru TH-1089)"
5-26B	Add "Climb-Two Engine (TH-1090 and After) (2-blade propeller installed)"
5-27	Add "Climb-Two Engine (TH-1090 and After) (3-blade propeller installed)"
7-1 thru 7-3	Revise "Table of Contents"
7-5	Revise "Control Column"
7-6 and 7-7	Shifted Material
7-10 and 7-11	Shifted Material
7-12	Revise "Brakes"
7-23	Revise "Fuel Flow Indicator"
7-27	Revise "Fuel Off-loading"
7-30	Revise "Alternators"
7-31	Shifted Material
7-32	Revise "Exterior Lighting"
7-34	Revise "Heater Operation"
7-35	Revise "Heat Regulation"
7-39	Revise "Stall Warning"
7-40A	Add "Windshield Anti-ice (Electrothermal)" and Shifted Material
7-41	Shifted Material
8-1 thru 8-3	Revise "Table of Contents"
8-5	Revise "Introduction"
8-6	Revise "Publications" and "Airplane Inspection Periods"
8-8	Shifted Material
8-9	Revise "Parking"
8-12	Revise "Preparation for Service"
8-15	Revise "Fuel Drains"
8-16	Revise "Oil System"
8-18A	Shifted Material
8-19	Add "Shock Strut Shimmy Damper"
8-23	Revise "Oxygen Cylinder Retesting"
8-24	Revise "Magentos"
8-25	Revise "Exterior Painted Surfaces"
8-30 thru 8-33	Revise "Lubrication Points"
8-36 thru 8-39	Revise "Recommended Servicing Schedule"
8-41 thru 8-44	Revise "Consumable Materials" and "Approved Engine Oils"
8-45	Revise "Bulb Replacement Guide"
8-50	Revise "Overhaul or Replacement Schedule"

98-38307

A4

**BARON 58 (TH-773 and After)
PILOT'S OPERATING HANDBOOK
AND
FAA APPROVED AIRPLANE FLIGHT MANUAL**

A3 July 1979

LOG OF REVISIONS

Page	Description
Title Page	Add Revision Date and Letter
Page A (A3)	Update
2-26 and 2-27	Revise Placards
2-28 and 2-29	Shifted Material
2-30	Revise Placards
2-31	Shifted Material
3-16	Shifted Material
3-17	Revise Emergency Exit
3-18 and 3-19	Shifted Material
7-17 and 7-18	Revise Openable Cabin Windows
7-18A	Revise Openable Cabin Windows
7-18B	Shifted Material

A3

BARON 58 (TH-773 and after)
 PILOT'S OPERATING HANDBOOK
 AND
 FAA APPROVED AIRPLANE FLIGHT MANUAL

A2.....October, 1978

LOG OF REVISIONS

Page	Description
Title	Add Revision Date and Letter
1-9	Rev. "ENGINES"
1-12	Rev. "Vmca" Definition
1-13	Rev. "Vsse" Definition
2-2	Rev. Table of Contents
2-3	Rev. "AIRSPEED LIMITATIONS"
2-4	Rev. "AIRSPEED LIMITATIONS"
2-5	Rev. "OIL"
2-9	Rev. "MANEUVERS"
2-23	Shifted Data
2-26	Add Placard
2-29	Rev. Placard
3-2	Rev. Table of Contents
3-3	Rev. "EMERGENCY AIRSPEEDS"
3-18	Delete "PRACTICE DEMONSTRATION OF Vmca"
4-2	Rev. Table of Contents
4-3	Rev. "SPEEDS FOR SAFE OPERATION"
4-25	Add "PRACTICE DEMONSTRATION of Vmca"
4-26	Add "PRACTICE DEMONSTRATION of Vmca"
7-18	Rev. "POWER PLANTS"
10-1 thru 10-37	Rev. "SAFETY SECTION"

98-38307

A2

**Baron 58 Pilot's Operating
Handbook and FAA Approved
Airplane Flight Manual**

A1 October, 1977

LOG OF REVISIONS

Page	Description
Title Page	Update
Page A (A1)	Update
a and b	Renumbered Pages
1-5 and 1-6	Revise "General" Information
2-27	Revise "Placards"
2-29	Revise "Placards"
5-36	Revise "Performance"
7-16	Rearrange Material
7-17	Add "NOTE"
7-43 and 7-44	Revise "Engine Break- in Information"
8-16	Revise "Oil System"
8-36	Revise "Recommended Servicing Schedule"
8-41	Revise "Consumable Materials"
8-45	Revise "Bulb Replacement Guide"

A1

**Baron 58 Pilot's Operating
Handbook and FAA Approved
Airplane Flight Manual**

Original October 1976

LOG OF REVISIONS EFFECTIVE PAGE

Date	Page	Description of Revision
October 1976	Title Page	Original
October 1976	a thru c	Original
October 1976	1-1 thru 1-20	Original
October 1976	2-1 thru 2-30	Original
October 1976	3-1 thru 3-20	Original
October 1976	4-1 thru 4-26	Original
October 1976	5-1 thru 5-48	Original
October 1976	6-1 thru 6-22	Original
October 1976	7-1 thru 7-44	Original
October 1976	8-1 thru 8-52	Original
	Section 9	See Log of Supplements
October 1976	10-1 thru 10-34	Original
		Original A

SECTION I

GENERAL

TABLE OF CONTENTS

<i>SUBJECT</i>	<i>PAGE</i>
Important Notice	1-3
Use of the Handbook	1-4
Revising the Handbook.....	1-5
Supplements Revision Record.....	1-6
Vendor-Issued STC Supplements	1-6
Airplane Three View.....	1-7
Ground Turning Clearance	1-8
Descriptive Data	1-9
Engines.....	1-9
Propellers.....	1-9
Fuel.....	1-10
Oil Capacity.....	1-11
Weights.....	1-11
Cabin Dimensions.....	1-11
Baggage.....	1-11
Specific Loadings.....	1-11
Symbols, Abbreviations and Terminology.....	1-12
Airspeed Terminology and Symbols.....	1-12
Meteorological Terminology.....	1-14
Power Terminology.....	1-15
Engine Controls and Instruments.....	1-16
Airplane Performance and Flight	
Planning Terminology.....	1-17
Weight and Balance Terminology.....	1-18
September, 1979	1-1

INTENTIONALLY LEFT BLANK

THANK YOU . . . for displaying confidence in us by selecting a BEECHCRAFT airplane. Our design engineers, assemblers and inspectors have utilized their skills and years of experience to ensure that the BEECHCRAFT Baron meets the high standards of quality and performance for which BEECHCRAFT airplanes have become famous throughout the world.

IMPORTANT NOTICE

This handbook must be read carefully by the owner and operator in order to become familiar with the operation of the BEECHCRAFT Baron. The handbook presents suggestions and recommendations to help obtain safe and maximum performance without sacrificing economy. The BEECHCRAFT Baron must be operated according to the Pilot's Operating Handbook and FAA Approved Airplane Flight Manual, and/or placards located in the airplane.

As a further reminder, the owner and operator of this airplane should also be familiar with the applicable Federal Aviation Regulations concerning operation and maintenance of the airplane and FAR Part 91 General Operating and Flight Rules. Likewise this airplane must be operated and maintained in accordance with FAA Airworthiness Directives which may be issued against it.

The Federal Aviation Regulations place the responsibility for the maintenance of this airplane on the owner and the operator who must ensure that all maintenance is done by qualified mechanics in conformity with all airworthiness requirements established for this airplane.

All limits, procedures, safety practices, time limits, servicing, and maintenance requirements contained in this handbook are considered mandatory for the continued airworthiness of this airplane, in a condition equal to that of its original manufacture.

Authorized BEEHCRAFT Aero or Aviation Centers or International Distributors or Dealers can provide recommended modification, service, and operating procedures issued by both the FAA and Beech Aircraft Corporation, which are designed to get maximum utility and safety from the airplane.

USE OF THE HANDBOOK

The Pilot's Operating Handbook is designed to maintain documents necessary for the safe and efficient operation of the Baron. The handbook has been prepared in loose leaf form for ease in maintenance and in a convenient size for storage. The handbook has been arranged with quick reference tabs imprinted with the title of each section and contains ten basic divisions:

- Section 1 General
- Section 2 Limitations
- Section 3 Emergency Procedures
- Section 4 Normal Procedures
- Section 5 Performance
- Section 6 Weight and Balance/Equipment List
- Section 7 Systems Description
- Section 8 Handling, Servicing and Maintenance
- Section 9 Supplements
- Section 10 Safety Information

NOTE

Except as noted, all airspeeds quoted in this handbook are Indicated Airspeeds (IAS) and assume zero instrument error.

In an effort to provide as complete coverage as possible, applicable to any configuration of the airplane, some optional equipment has been included in the scope of the handbook. However, due to the variety of airplane appointments and arrangements available, optional equipment described and depicted herein may not be designated as such in every case.

The following information may be provided to the holder of this manual automatically:

1. Original issues and revisions of Beechcraft Service Bulletins
2. Original issues and revisions of FAA Approved Airplane Flight Manual Supplements
3. Reissues and revisions of FAA Approved Airplane Flight Manuals, Flight Handbooks, Owner's Manuals, Pilot's Operating Manuals, and Pilot's Operating Handbooks

This service is free and will be provided only to holders of this handbook who are listed on the FAA Aircraft Registration Branch List or the BEECHCRAFT International Owners Notification Service List, and then only if listed by airplane serial number for the model for which this handbook is applicable. For detailed information on how to obtain "Revision Service"

Section I
General

BEEHCRAFT Baron 58
Serial TH 773 and After

applicable to this handbook or other BEEHCRAFT Service Publications, consult a BEEHCRAFT Aero or Aviation Center, International Distributor or Dealer, or refer to the latest revision of BEEHCRAFT Service Instructions No. 2001.

Beech Aircraft Corporation expressly reserves the right to supersede, cancel, and/or declare obsolete, without prior notice, any part, part number, kit, or publication referenced in this manual.

The owner/operator should always refer to all supplements, whether STC Supplements or Beech Supplements, for possible placards, limitations, normal, emergency and other operational procedures for proper operation of the airplane with optional equipment installed.

REVISING THE HANDBOOK

Immediately following the Title Page is the "Log of Revisions" page(s). The Log of Revisions pages are used for maintaining a listing of all effective pages in the handbook (except the SUPPLEMENTS section), and as a record of revisions to these pages. In the lower right corner of the outlined portion of the Log of Revisions is a box containing a capital letter which denotes the issue or reissue of the handbook. This letter may be suffixed by a number which indicates the numerical revision. When a revision to any information in the handbook is made, a new Log of Revisions will be issued. All Logs of Revisions must be retained in the handbook to provide a current record of material status until a reissue is made.

WARNING

When this handbook is used for airplane operational purposes it is the pilot's responsibility to maintain it in current status.

SUPPLEMENTS REVISION RECORD

Section IX contains the FAA Approved Airplane Flight Manual Supplements headed by a Log of Supplements page. On the "Log" page is a listing of the FAA Approved Supplemental Equipment available for installation on the BEEHCRAFT Baron 58. When new supplements are received or existing supplements are revised, a new "Log" page will replace the previous one, since it contains a listing of all previous approvals, plus the new approval. The supplemental material will be added to the grouping in accordance with the descriptive listing.

NOTE

Upon receipt of a new or revised supplement, compare the "Log" page you have just received with the "Log" page in the manual. Retain the "Log" page with the latest date on the bottom of the page and discard the other log.

VENDOR-ISSUED STC SUPPLEMENTS

When a new airplane is delivered from the factory, the handbook will contain either an STC (Supplemental Type Certificate) Supplement or a Beech Flight Manual Supplement for all items requiring a supplement. If a new handbook is purchased at a later date for operation of the airplane, it is the responsibility of the owner/operator to see that all required STC Supplements (as well as weight and balance and other pertinent data) are retained for use in the new handbook.

BEECHCRAFT Baron 58
Serial TH 773 and After

Section I
General

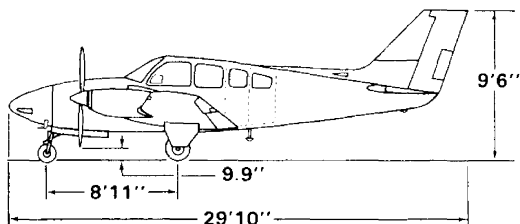
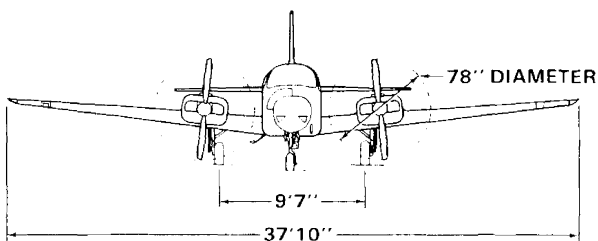
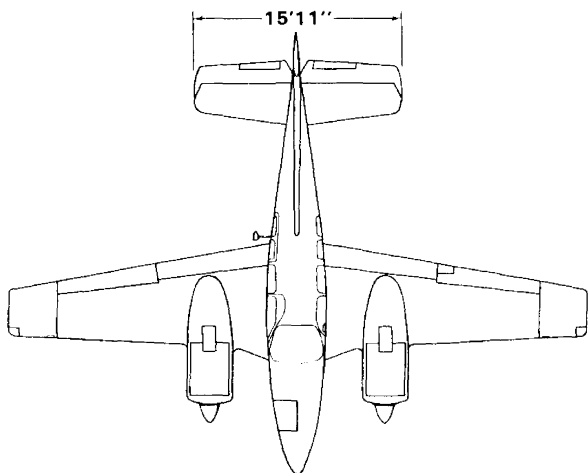

GROUND TURNING CLEARANCE

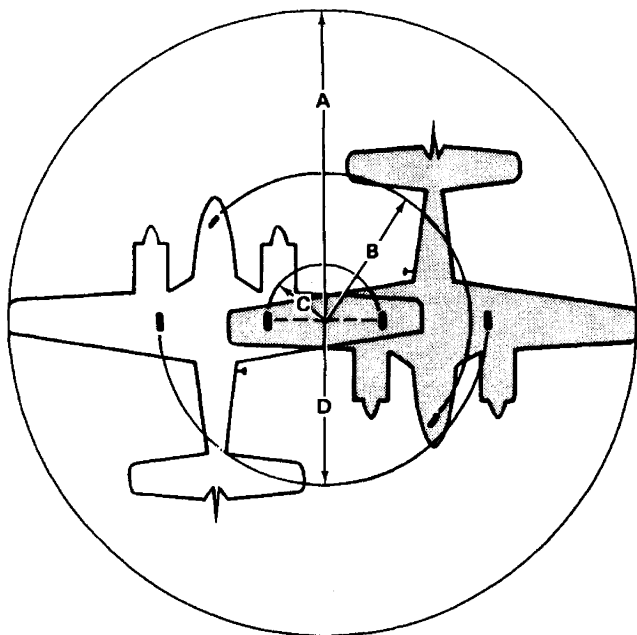

- A Radius for Wing Tip 31 feet 6 inches
- B Radius for Nose Wheel 15 feet 6 inches
- C Radius for Inside Gear 7 feet 11 inches
- D Radius for Outside Gear 17 feet 6 inches

TURNING RADII ARE PREDICATED ON THE USE OF PARTIAL BRAKING ACTION AND DIFFERENTIAL POWER.

DESCRIPTIVE DATA

ENGINES

Two Continental IO-520-C or IO-520-CB fuel-injected, air-cooled six-cylinder, horizontally opposed engines each rated at 285 horsepower at 2700 rpm.

Take-off and Maximum

Continuous Power.....	Full Throttle and 2700 rpm
Maximum Normal Operating Power (TH-1090 and After)	
With 2-blade propellers	
installed.....	Full Throttle and 2550 rpm
With 3-blade propellers	
installed.....	Full Throttle and 2650 rpm
Maximum One-Engine	
Inoperative Power.....	Full Throttle and 2700 rpm
Cruise Climb Power.....	25.0 in. Hg at 2500 rpm
Maximum Cruise Power.....	24.5 in. Hg at 2500 rpm

PROPELLERS

HARTZELL

2 Blade Hubs: BHC-J2YF-2CUF

Blades: FC8475-6

Spinner: C-2285-6P

Pitch Setting at 30 inch Station: Low 14.5°; Feathered 80.0°

Diameter: 78 inches maximum, 76 inches minimum

3 Blade Hubs: PHC-J3YF-2UF

Blades: FC7663-2R

Spinner: C-3567-1P

Pitch Setting at 30 inch Station: Low 13.0°; Feathered 82.0°

Diameter: 76 inches maximum, 74 inches minimum

Section I
General

BEECHCRAFT Baron 58
Serial TH 773 and After

McCAULEY (TH-773 thru TH-1089)

2 Blade Hubs: D2AF34C30

Blades: 78FF-0

Spinner: D-3953 or D-4046

Pitch Setting at 30 inch Station: Low 15.0°; Feathered 79.0°

Diameter: 78 inches maximum, 76 inches minimum

3 Blade Hubs: D3AF32C35

Blades: 82NB-6

Spinner: PD-4068 or PD-4069

Pitch Setting at 30 inch Station: Low 14.0° ± .2°; Feathered 81.2° ± .3°

Diameter: 76 inches, no cut-off permitted

FUEL

Aviation Gasoline 100LL (blue) or 100 (green) minimum grade; 115/145 (purple) Aviation Gasoline alternate grade.

STANDARD SYSTEM:

Total Capacity	142 Gallons
Total Usable	136 Gallons

OPTIONAL SYSTEMS:

Total Capacity	172 Gallons
Total Usable	166 Gallons

or

Total Capacity	200 Gallons
Total Usable	194 Gallons

OIL

The oil capacity is 12 quarts for each engine.

WEIGHTS

58

Maximum Ramp Weight	5424 lbs
Maximum Take-Off Weight	5400 lbs
Maximum Landing Weight	5400 lbs

58A

Maximum Ramp Weight	5014 lbs
Maximum Take-Off Weight	4990 lbs
Maximum Landing Weight	4990 lbs

CABIN DIMENSIONS

Length	12 ft 7 in.
Height (Max.)	4 ft 2 in.
Width (Max.)	3 ft 6 in.
Entrance Door	37 in. x 36 in.
Utility Door Opening	45 in. x 35 in.

BAGGAGE

Aft cabin compartment	37 cu ft
Extended rear compartment	10 cu ft
Nose compartment	18 cu ft

SPECIFIC LOADINGS

Wing Loading	27.1 lbs/sq ft
Power Loading	9.47 lbs/hp

SYMBOLS, ABBREVIATIONS AND TERMINOLOGY

The following Abbreviations and Terminologies have been listed for convenience and ready interpretation where used within this handbook. Whenever possible, they have been categorized for ready reference.

AIRSPPEED TERMINOLOGY AND SYMBOLS

CAS Calibrated Airspeed is the indicated speed of an airplane, corrected for position and instrument error. Calibrated airspeed is equal to true airspeed in standard atmosphere at sea level.

GS Ground Speed is the speed of an airplane relative to the ground.

IAS Indicated Airspeed is the speed of an airplane as shown on the airspeed indicator. IAS values published in this handbook assume zero instrument error.

TAS True Airspeed is the airspeed of an airplane relative to undisturbed air which is the CAS corrected for altitude, temperature, and compressibility.

V_{MCA} Air Minimum Control Speed is the minimum flight speed at which the airplane is directionally controllable as determined in accordance with Federal Aviation Regulations. The airplane certification conditions include one engine becoming inoperative and windmilling, a 5-degree bank towards the operative engine, take-off power on operative engine, landing gear up, flaps in take-off position, and most rearward C.G. For some conditions of weight and altitude, stall

can be encountered at speeds above V_{MCA} as established by the Certification procedure described above, in which event stall speed must be regarded as the limit of effective directional control.

- V_{SSE} The Intentional One-Engine-Inoperative Speed is a speed above both V_{MCA} and stall speed, selected to provide a margin of lateral and directional control when one engine is suddenly rendered inoperative. Intentional failing of one engine below this speed is not recommended.
- V_A Maneuvering Speed is the maximum speed at which application of full available aerodynamic control will not overstress the airplane.
- V_F Design flap speed is the highest speed permissible at which wing flaps may be actuated.
- V_{FE} Maximum Flap Extended Speed is the highest speed permissible with wing flaps in a prescribed extended position.
- V_{LE} Maximum Landing Gear Extended Speed is the maximum speed at which an airplane can be safely flown with the landing gear extended.
- V_{NE} Never Exceed Speed is the speed limit that may not be exceeded at any time.
- V_{LO} Maximum Landing Gear Operating Speed is the maximum speed at which the landing gear can be safely extended or retracted.
- V_{NO} Maximum Structural Cruising Speed is the speed that should not be exceeded except or V_C in smooth air and then only with caution.

V_S Stalling Speed or the minimum steady flight speed at which the airplane is controllable.

V_{SO} Stalling Speed or the minimum steady flight speed at which the airplane is controllable in the landing configuration.

V_X Best Angle-of-Climb Speed is the airspeed which delivers the greatest gain of altitude in the shortest possible horizontal distance.

V_Y Best Rate-of-Climb Speed is the airspeed which delivers the greatest gain in altitude in the shortest possible time.

METEOROLOGICAL TERMINOLOGY

ISA International Standard Atmosphere in which

- (1) The air is a dry perfect gas;
- (2) The temperature at sea level is 15° Celsius (59° Fahrenheit);
- (3) The pressure at sea level is 29.92 inches Hg. (1013.2 millibars);
- (4) The temperature gradient from sea level to the altitude at which the temperature is -56.5° C (-69.7° F) is -0.00198° C (-0.003566° F) per foot and zero above that altitude.

OAT Outside Air Temperature is the free air static temperature, obtained either from inflight temperature indications adjusted for instrument error and compressibility effects, or ground meteorological sources.

Indicated Pressure Altitude The number actually read from an altimeter when the barometric sub-scale has been set to 29.92 inches of mercury (1013.2 millibars).

Pressure Altitude	Altitude measured from standard sea-level pressure (29.92 in. Hg) by a pressure or barometric altimeter. It is the indicated pressure altitude corrected for position and instrument error. In this Handbook, altimeter instrument errors are assumed to be zero. Position errors may be obtained from the Altimeter Correction Chart.
Station Pressure	Actual atmospheric pressure at field elevation.
Wind	The wind velocities recorded as variables on the charts of this handbook are to be understood as the headwind or tailwind components of the reported winds.

POWER TERMINOLOGY

Take-off and Maximum Continuous	The highest power rating not limited by time.
Cruise Climb	Power recommended for cruise climb.
Maximum Cruise	The highest power settings recommended for cruise.
Recommended Cruise	Intermediate power settings for which cruise power settings are presented.
Economy Cruise	The lowest power setting for which cruise power settings are presented.

- Maximum Normal Operating Power (MNOP)
- Highest power rating within the normal operating range. Noise characteristics requirements of FAR 36 have been demonstrated at this power rating.

ENGINE CONTROLS AND INSTRUMENTS

TERMINOLOGY

Throttle Controls The lever used to control the introduction of a fuel-air mixture into the intake passages of an engine.

Propeller Controls This lever requests the governor to maintain rpm at a selected value and, in the maximum decrease rpm position, feathers the propellers.

Mixture Controls This lever, in the idle cut-off position, stops the flow of fuel at the injectors and in the intermediate thru the full rich positions, regulates the fuel air mixture.

Propeller Governors The governors maintain the selected rpm requested by the propeller control levers.

Manifold Pressure Gage An instrument that measures the absolute pressure in the intake manifold of an engine, expressed in inches of mercury (in. Hg).

Tachometer An instrument that indicates the rotational speed of the propeller (and engine) in revolutions per minute (rpm).

AIRPLANE PERFORMANCE AND FLIGHT PLANNING TERMINOLOGY

Climb Gradient The ratio of the change in height during a portion of a climb, to the horizontal distance traversed in the same time interval.

Demonstrated Crosswind Velocity The demonstrated crosswind velocity is the velocity of the crosswind component for which adequate control of the airplane during take-off and landing was actually demonstrated during certification tests.

Accelerate-Stop Distance The distance required to accelerate to a specified speed and, assuming failure of an engine at the instant that speed is attained, to bring the airplane to a stop.

Accelerate-Go Distance The distance required to accelerate to a specified speed and, assuming failure of an engine at the instant that speed is attained, feather inoperative propeller and continue takeoff on the remaining engine to a height of 50 feet.

MEA Minimum enroute IFR altitude.

**Section I
General**

**BEECHCRAFT Baron 58
Serial TH 773 and After**

Route Segment	A part of a route. Each end of that part is identified by: (1) a geographical location; or (2) a point at which a definite radio fix can be established.
GPH	U.S. Gallons per hour.

WEIGHT AND BALANCE TERMINOLOGY

Reference Datum	An imaginary vertical plane from which all horizontal distances are measured for balance purposes.
Station	A location along the airplane fuselage usually given in terms of distance from the reference datum.
Arm	The horizontal distance from the reference datum to the center of gravity (C.G.) of an item.
Moment	The product of the weight of an item multiplied by its arm. (Moment divided by a constant is used to simplify balance calculations by reducing the number of digits.)
Airplane Center of Gravity (C.G.)	The point at which an airplane would balance if suspended. Its distance from the reference datum is found by dividing the total moment by the total weight of the airplane.

C.G. Arm	The arm obtained by adding the airplane's individual moments and dividing the sum by the total weight.
C.G. Limits	The extreme center of gravity locations within which the airplane must be operated at a given weight.
Usable Fuel	Fuel available for flight planning.
Unusable Fuel	Fuel remaining after a runout test has been completed in accordance with governmental regulations.
Standard Empty Weight	Weight of a standard airplane including unusable fuel, full operating fluids and full oil.
Basic Empty Weight	Standard empty weight plus optional equipment.
Payload	Weight of occupants, cargo and baggage.
Useful Load	Difference between ramp weight and basic empty weight.
Maximum Ramp Weight	Maximum weight approved for ground maneuvering. (It includes weight of start, taxi, and run up fuel).
Maximum Take-off Weight	Maximum weight approved for the start of the take off run.

**Section I
General**

**BEECHCRAFT Baron 58
Serial TH 773 and After**

**Maximum
Landing
Weight**

**Maximum weight approved for the
landing touchdown.**

**Zero Fuel
Weight**

Weight exclusive of usable fuel.

SECTION II

LIMITATIONS

TABLE OF CONTENTS

<i>SUBJECT</i>	<i>PAGE</i>
Airspeed Limitations	2-3
Airspeed Indicator Markings	2-4
Power Plant Limitations	2-5
Engines	2-5
Fuel	2-5
Oil	2-5
Propellers	2-6
Starters - Time for Cranking	2-6
Power Plant Instrument Markings	2-7
Oil Temperature	2-7
Oil Pressure	2-7
Fuel Flow and Pressure	2-7
Fuel Flow	2-7
Manifold Pressure	2-7
Tachometer	2-7
Cylinder Head Temperature	2-8
Miscellaneous Instrument Markings	2-8
Instrument Pressure	2-8
Propeller Deice Ammeter	2-8
Fuel Quantity	2-8
Weights	2-8
CG Limits	2-9
Maneuvers	2-9
Flight Load Factors (5400 Pounds)	2-10
September, 1980	2-1

TABLE OF CONTENTS (Continued)

<i>SUBJECT</i>	<i>PAGE</i>
Minimum Flight Crew	2-10
Kinds of Operation	2-10
Fuel.....	2-10
Oxygen Requirements.....	2-11
Maximum Passenger Seating	
Configuration.....	2-11
Seating	2-11
Placards.....	2-12
Kinds of Operations	
Equipment List	2-24

The limitations included in this section have been approved by the Federal Aviation Administration and must be observed in the operation of this airplane.

AIRSPPEED LIMITATIONS

SPEED	CAS	IAS	REMARKS
	KNOTS	KNOTS	
Never Exceed V_{NE}	223	223	Do not exceed this speed in any operation
Maximum Structural Cruising V_{NO} or V_C	195	195	Do not exceed this speed except in smooth air and then only with caution
Maneuvering V_A	156	156	Do not make full or abrupt control movements above this speed
Maximum Flap Extension/ Extended V_{FE} (Approach 15°) (Full Down 30°)	152	152	Do not extend flaps or operate with flaps extended above this speed
	122	122	
Maximum Landing Gear Operating/ Extended V_{LO} and V_{LE}	152	152	Do not extend, retract or operate with gear extended above this speed
Air Minimum Control Speed V_{MCA}	81	81	Minimum speed for directional controllability after sudden loss of engine
Maximum With Utility Doors Removed	174	174	Utility door removal kit must be installed

***AIRSPEED INDICATOR MARKINGS**

MARKING	CAS	IAS	SIGNIFICANCE
	KNOTS	KNOTS	
White Arc	72-122	74-122	Full Flap Operating Range
White Triangle**	152	152	Maximum Flap Approach Position 15°
Blue Radial	100	100	Single-Engine Best Rate-of-Climb Speed
Red Radial	81	81	Minimum Single-Engine Control (V _{MCA})
Green Arc	83-195	84-195	Normal Operating Range
Yellow Arc	195-223	195-223	Operate with caution, only in smooth air
Red Radial	223	223	Maximum speed for ALL operations

*The Airspeed Indicator is marked in IAS values

**Series TH-1080 and After

POWER PLANT LIMITATIONS

ENGINES

Two Continental IO-520-C (Prior to TH-973) or IO-520-CB (TH-973 and after) fuel-injected, air-cooled, six-cylinder, horizontally opposed engines each rated at 285 horsepower at 2700 rpm.

Take-off and Maximum

Continuous Power.....	Full Throttle and 2700 rpm
Maximum Normal Operating Power (TH-1090 and After) ■	
With 2-blade propellers	
installed.....	Full Throttle and 2550 rpm
With 3-blade propellers	
installed.....	Full Throttle and 2650 rpm
Maximum Cylinder Head Temperature	460°F
Maximum Oil Temperature	240°F
Minimum Take-off Oil Temperature	75°F
Minimum Oil Pressure (idle).....	30 psi
Maximum Oil Pressure.....	100 psi

FUEL

Aviation Gasoline 100LL (blue) preferred, 100 (green) minimum grade.

OIL

Ashless dispersant oils must meet Continental Motors Corporation Specification MHS-24B. Refer to APPROVED ENGINE OILS, Servicing Section.

Section II
Limitations

BEECHCRAFT Baron 58
Serial TH 773 and After

PROPELLERS

HARTZELL

2 Blade Hubs: BHC-J2YF-2CUF

Blades: FC8475-6

Spinner: C-2285-6P

Pitch Setting at 30 inch Station: Low 14.5°; Feathered 80.0°

Diameter: 78 inches maximum, 76 inches minimum

3 Blade Hubs: PHC-J3YF-2UF

Blades: FC7663-2R

Spinner: C-3567-1P

Pitch Setting at 30 inch Station: Low 13.0°; Feathered 82.0°

Diameter: 76 inches maximum, 74 inches minimum

McCAULEY (TH-773 thru TH-1089)

2 Blade Hubs: D2AF34C30

Blades: 78FF-0

Spinner: D-3953 or D-4046

Pitch Setting at 30 inch Station: Low 15.0°; Feathered 79.0°

Diameter: 78 inches maximum, 76 inches minimum

3 Blade Hubs: D3AF32C35

Blades: 82NB-6

Spinner: PD-4068 or PD-4069

Pitch Setting at 30 inch Station: Low 14.0° ± .2°; Feathered 81.2° ± .3°

Diameter: 76 inches, no cut-off permitted

STARTERS - TIME FOR CRANKING

Do not operate starter continuously for more than 30 seconds. Allow starter to cool again before cranking.

POWER PLANT INSTRUMENT MARKINGS

OIL TEMPERATURE

Caution (Yellow Radial).....	75°F
Operating Range (Green Arc).....	75° to 240°F
Maximum (Red Radial).....	240°F

OIL PRESSURE

Minimum Pressure (Red Radial).....	30 psi
Operating Range (Green Arc).....	30 to 60 psi
Maximum Pressure (Red Radial).....	100 psi

FUEL FLOW AND PRESSURE

Serials TH-773 thru TH-1193:

Minimum (Red Radial).....	1.5 psi
Operating Range (Green Arc).....	1.5 psi to 24.3 gph
Cruise Power (Green Arc).....	9.7 gph to 17.0 gph
Take-off and Climb Power (Wide Green Arc).....	17.8 gph to 24.3 gph
Maximum (Red Radial).....	17.5 psi

FUEL FLOW

Serials TH-1194 and after:

Operating Range (Green Arc).....	6.9 to 24.3 gph
Take-off and Climb Power (White Radials).....	17.8 to 24.3 gph
Maximum (Red Radial).....	24.3 gph

MANIFOLD PRESSURE

Operating Range (Green Arc).....	15 to 29.6 in. Hg
Maximum (Red Radial).....	29.6 in. Hg

TACHOMETER

Operating Range (Green Arc) (Serials TH-773 thru TH-1089).....	2000 to 2700 rpm
Operating Range (Green Arc) (Serials TH-1090 and after)	
With 2-blade propellers installed.....	2000 to 2550 rpm
With 3-blade propellers installed.....	2000 to 2650 rpm
Maximum (Red Radial).....	2700 rpm

Section II
Limitations

BEECHCRAFT Baron 58
Serial TH 773 and After

CYLINDER HEAD TEMPERATURE

Operating Range (Green Arc) 200° to 460°F
Maximum Temperature (Red Radial) 460°F

MISCELLANEOUS INSTRUMENT MARKINGS

INSTRUMENT PRESSURE

Normal (Green Arc) 4.3 to 5.9 in. Hg
Red Button Source Failure
Indicators

PROPELLER DEICE AMMETER

Normal Operating Range
(Green Arc) 7 to 12 amps (2 blade)
Normal Operating Range
(Green Arc) 14 to 18 amps (3 blade)

FUEL QUANTITY

Yellow Arc E to 1/8 Full

WEIGHTS

58

Maximum Ramp Weight 5424 lbs
Maximum Take-Off Weight 5400 lbs
Maximum Landing Weight 5400 lbs

58A

Maximum Ramp Weight 5014 lbs
Maximum Take-Off Weight 4990 lbs
Maximum Landing Weight 4990 lbs

Maximum Baggage/Cargo Compartment Weights:

Aft Cabin compartment
(less occupants and equipment) 400 lbs
Extended Rear Compartment 120 lbs
Nose Compartment (baggage less
equipment) 300 lbs

Refer to Weight and Balance section for additional information.

CG LIMITS

Baron 58

Forward Limits: 74 inches aft of datum at 4200 lbs and under, then straight line variation to 78.0 inches aft of datum at gross weight of 5400 lbs.

Aft Limits: 86 inches aft of datum at all weights.

Baron 58A

Forward Limits: 74 inches aft of datum at 4200 lbs and under, then straight line variation to 76.6 inches aft of datum at gross weight of 4990 lbs.

Aft Limits: 86 inches aft of datum at all weights.

Datum is 83.1 inches forward of center line through forward jack points.

MAC leading edge is 67.2 inches aft of datum.
MAC length is 63.1 inches.

MANEUVERS

This is a normal category airplane. Acrobatic maneuvers, including spins, are prohibited.

FLIGHT LOAD FACTORS (5400 POUNDS)

Positive maneuvering load factors:

Flaps Up	4.2 G
Flaps Down	2.0 G

MINIMUM FLIGHT CREW. One Pilot

KINDS OF OPERATION

This airplane is approved for the following type operations when the required equipment is installed and operational as defined herein:

1. VFR day and night
2. IFR day and night

WARNING

Ice protection equipment which may be installed on this airplane has not been demonstrated to meet requirements for flight into known icing conditions.

FUEL

TOTAL FUEL with left and right wing fuel systems full:

Standard Fuel System

Capacity	142 Gallons
Usable	136 Gallons

Optional Fuel System

Capacity	172 Gallons
Usable	166 Gallons

or

Capacity	200 Gallons
Usable	194 Gallons

Do not take off if Fuel Quantity Gages indicate in Yellow Arc or with less than 13 gallons in each wing fuel system.

The fuel crossfeed system to be used during emergency conditions in level flight only.

Maximum slip duration: 30 seconds

OXYGEN REQUIREMENTS

One mask for minimum crew and one mask per passenger with an adequate supply of oxygen when operating above 12,500 feet (MSL). Refer to FAR 91 for variations concerning supplemental oxygen requirements for a particular flight.

**MAXIMUM PASSENGER SEATING
CONFIGURATION**

Five (5) passengers and one (1) pilot

SEATING

All occupied seats must be in the upright position for take-off and landing.

**Section II
Limitations**

**BEECHCRAFT Baron 58
Serial TH 773 and After**

PLACARDS

On Left Side Panel:

TURN STROBE LIGHTS OFF WHEN TAXIING IN
VICINITY OF OTHER AIRCRAFT OR WHEN
FLYING IN FOG OR CLOUDS. STANDARD POSITION LIGHTS
TO BE USED FOR ALL NIGHT OPERATIONS

*On Pilot's Left Sidewall Panel (58) (Serials TH-773 Thru
TH-1079, Except TH-1027, TH-1062 and TH-1067):*

THIS AIRPLANE MUST BE OPERATED AS A NORMAL CATEGORY
AIRPLANE IN COMPLIANCE WITH THE OPERATING LIMITATIONS
STATED IN THE FORM OF PLACARDS, MARKINGS, AND MANUALS.

(PILOT'S CHECK LIST)

OCCUPIED SEATS MUST BE IN UPRIGHT POSITION DURING
TAKE-OFF AND LANDING

MAXIMUM WEIGHT 5400 LBS

NO ACROBATIC MANEUVERS INCLUDING SPINS APPROVED
AIRSPEED LIMITATIONS

MAX. SPEED WITH LDG GEAR EXTENDED (NORMAL) 152 KTS

MAX. SPEED WITH FLAPS EXTENDED (15° DOWN) 152 KTS

MAX. SPEED WITH FLAPS EXTENDED (NORMAL) 122 KTS

MAX. DESIGN MANEUVER SPEED 156 KTS

MIN CONTROL SPEED SINGLE ENGINE 81 KTS

NEVER EXCEED SPEED 223 KTS

MAX. STRUCTURAL CRUISE SPEED 195 KTS

*On Pilot's Left Sidewall Panel (58A) (Serials TH-773 Thru
TH-1079, Except TH-1027, TH-1062 and TH-1067):*

THIS AIRPLANE MUST BE OPERATED AS A NORMAL CATEGORY
AIRPLANE IN COMPLIANCE WITH THE OPERATING LIMITATIONS
STATED IN THE FORM OF PLACARDS, MARKINGS, AND MANUALS.

(PILOT'S CHECK LIST)

OCCUPIED SEATS MUST BE IN UPRIGHT POSITION DURING
TAKE-OFF AND LANDING

MAXIMUM WEIGHT 4990 LBS

NO ACROBATIC MANEUVERS INCLUDING SPINS APPROVED
AIRSPEED LIMITATIONS

MAX. SPEED WITH LDG GEAR EXTENDED (NORMAL) 152 KTS

MAX. SPEED WITH FLAPS EXTENDED (15° DOWN) 152 KTS

MAX. SPEED WITH FLAPS EXTENDED (NORMAL) 122 KTS

MAX. DESIGN MANEUVER SPEED 156 KTS

MIN CONTROL SPEED SINGLE ENGINE 81 KTS

NEVER EXCEED SPEED 223 KTS

MAX. STRUCTURAL CRUISE SPEED 195 KTS

On Left Sidewall (58 & 58A) (Serials TH-1027, TH-1062, TH-1067, TH-1080 and after):



AIRSPEED LIMITATIONS	
MAX. LDG GEAR EXTENDED (NORMAL)	-----152 KTS
MAX. FLAPS EXTENDED (15° DOWN)	-----152 KTS
MAX. FLAPS EXTENDED (NORMAL)	-----122 KTS
MAX. DESIGN MANEUVER SPEED	----156 KTS
MIN. CONTROL SPEED SINGLE ENGINE	----81 KTS
NEVER EXCEED SPEED	-----223 KTS
MAX. STRUCTURAL CRUISE SPEED	----195 KTS



On Upper Left Hand Side Panel (58) (Serials TH-1027, TH-1062, TH-1067, TH-1080 and after):

OPERATION LIMITATIONS	
THIS AIRPLANE MUST BE OPERATED AS A NORMAL CATEGORY AIRPLANE IN COMPLIANCE WITH THE OPERATING LIMITATIONS STATED IN THE FORM OF PLACARDS, MARKINGS, AND MANUALS. MAXIMUM WEIGHT IS 5400 LBS.	
(PILOT'S CHECK LIST)	
OCCUPIED SEATS MUST BE IN UPRIGHT POSITION FOR TAKEOFF AND LANDING. NO ACROBATIC MANEUVERS INCLUDING SPINS APPROVED.	

On Upper Left Hand Side Panel (58A) (Serials TH-1027, TH-1062, TH-1067, TH-1080 and after):

OPERATION LIMITATIONS	
THIS AIRPLANE MUST BE OPERATED AS A NORMAL CATEGORY AIRPLANE IN COMPLIANCE WITH THE OPERATING LIMITATIONS STATED IN THE FORM OF PLACARDS, MARKINGS, AND MANUALS. MAXIMUM WEIGHT IS 4990 LBS.	
(PILOT'S CHECK LIST)	
OCCUPIED SEATS MUST BE IN UPRIGHT POSITION FOR TAKEOFF AND LANDING. NO ACROBATIC MANEUVERS INCLUDING SPINS APPROVED.	

Section II
Limitations

BEECHCRAFT Baron 58
Serial TH 773 and After

Between Fuel Selector Handles:

Standard 136 Gallon System

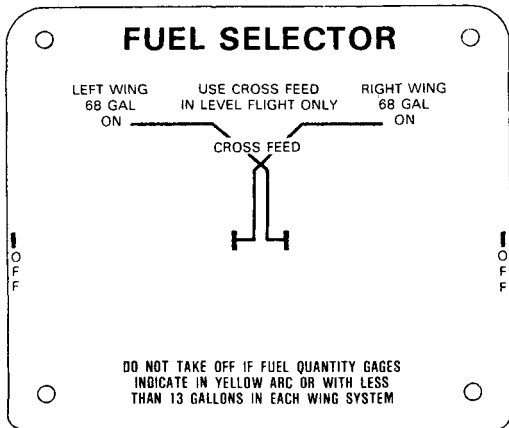

Optional 166 Gallon System

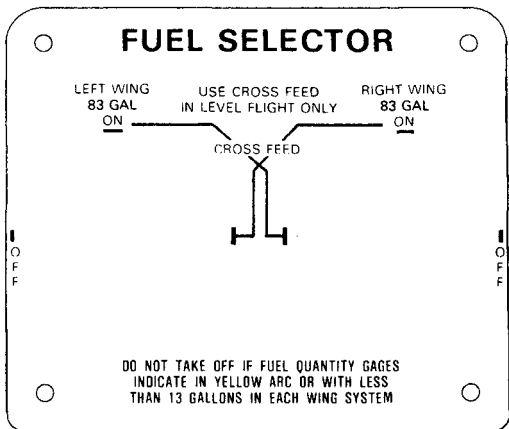

**Temporary Change
to the
Pilot's Operating Handbook
and
FAA Approved Airplane Flight Manual
P/N 58-590000-21TC1**

Publication Affected	58 and 58A Pilot's Operating Handbook and FAA Approved Airplane Flight Manual (P/N 58-590000-21, Issued October, 1976 or Subsequent)
Airplane Serial Numbers Affected	TH-773 thru TH-1395, except TH-1389
Description of Change	The addition of a placard to the fuel selectors to warn of the no-flow condition that exists between the fuel selector detents.
Filing Instructions	Insert this temporary change into the 58 and 58A Pilot's Operating Handbook and FAA Approved Airplane Flight Manual immediately following page 2-14 (Section II, LIMITATIONS) and retain until rescinded or replaced.

LIMITATIONS

PLACARDS

Located On The Face Of The Fuel Selector Valves, For Those Airplanes In Compliance With S.B. 2670:

**WARNING - POSITION SELECTORS IN DETENTS ONLY -
NO FUEL FLOW TO ENGINES BETWEEN DETENTS**

Approved:

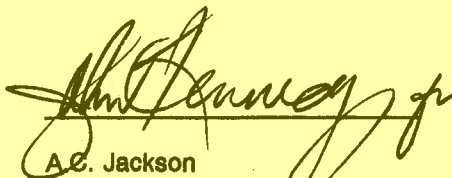

A.C. Jackson
Raytheon Aircraft Company
DOA CE-2

Between Fuel Selector Handles Con't.

Optional 194 Gallon System

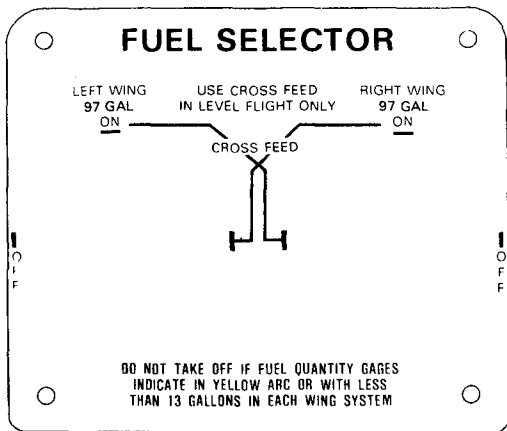

On Inboard Side Of Seat Backs For 3rd And 4th Seats:

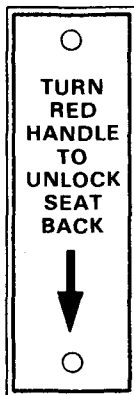

On Top of Front Spar Carry-Thru Structure Between Front Seats:

**EMERGENCY
LANDING GEAR
INSTRUCTIONS
TO EXTEND**

ENGAGE HANDLE IN REAR
OF FRONT SEAT AND TURN
COUNTERCLOCKWISE AS FAR
AS POSSIBLE (50 TURNS)

On Emergency Crank Access Cover:

**LANDING GEAR
EMERGENCY CRANK**

PULL OUT

LIFT UP

On Instrument Panel When Anti-Collision Lights Are Not Installed:

**THIS AIRCRAFT NOT FULLY
EQUIPPED FOR NIGHT FLIGHT**

On Lower Sidewall Adjacent to Pilot:

WARNING

EMERGENCY AIRSPEED STATIC SOURCE
ON
EMERGENCY

SEE PILOTS CHECK LIST
OR FLIGHT MANUAL
EMERGENCY PROCEDURES
FOR AIRSPEED & ALTIMETER
CALIBRATION ERROR



OFF
NORMAL

OR

WARNING

STATIC AIR DRAIN
VALVE TO BE CLOSED
BEFORE FLIGHT

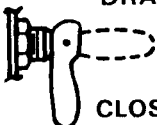

OPEN
DRAIN

CLOSE
DRAIN

Adjacent To Cabin Door Handle:

ROTATE HANDLE TO
FULL LOCKED POSITION



Section II
Limitations

BEECHCRAFT Baron 58
Serial TH 773 and After

*Below Left and Right Openable Windows After Compliance
with BEECHCRAFT Service Instructions 1241:*

*(Serials TH-773 thru TH-1079, Except TH-1027, TH-1062
and TH-1067):*

EMERGENCY EXIT
LIFT LATCH - PULL PIN
PUSH WINDOW OUT

*On Face of Emergency Exit Latch Cover (Serials TH-1027,
TH-1062, TH-1067, TH-1080 and After):*

EMERGENCY EXIT
PULL COVER
ROTATE HANDLE UP
BREAKING SAFETY WIRE
PUSH WINDOW OUT

On Emergency Exit Handle (TH-1027, TH-1062, TH-1067, TH-1080 and After):

ROTATE HANDLE UP
BREAKING SAFETY
WIRE
PUSH WINDOW OUT

On Openable Cabin Windows:

DO NOT OPEN
IN FLIGHT

LATCH WINDOW
BEFORE TAKE-OFF

Adjacent to Openable Cabin Window Handles (Serials TH-1316 and after):

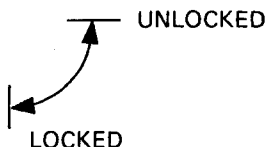

On Oxygen Console:

OXYGEN
NO SMOKING WHEN IN USE
HOSE PLUG MUST BE PULLED OUT TO STOP OXYGEN FLOW

On Each Oxygen Mask Stowage Container:

OXYGEN MASK

Section II
Limitations

BEECHCRAFT Baron 58
Serial TH 773 and After

On Each Passenger Outlet (Serials TH-773 Thru TH-1079, Except TH-1027, TH-1062 and TH-1067) and On All Pilot and Copilot Outlets (All Serials):

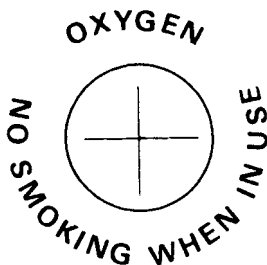

On Oxygen Manifold (Serials TH-1027, TH-1062, TH-1067 and TH-1080 and after):

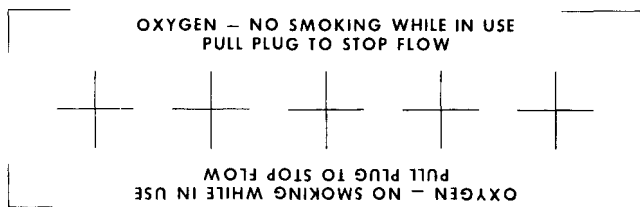

Adjacent to Oxygen Outlet when 5th & 6th Seats Are Installed:

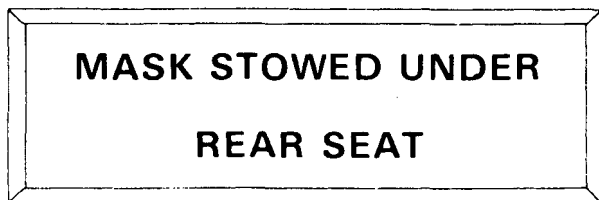

On Windows Adjacent to Pilot's and Copilot's Seat:

**SHOULDER HARNESS
MUST BE WORN AT
ALL TIMES WHILE AT
PILOT POSITIONS**

*On Windows Adjacent to 5th & 6th Seats And 3rd & 4th
Forward Facing Seats:*

**SHOULDER HARNESS
MUST BE WORN DURING
TAKE-OFF AND LANDING
WITH SEAT BACK UPRIGHT**

On Windows Adjacent to 3rd & 4th Aft Facing Club Seats:

**SHOULDER HARNESS
MUST BE WORN DURING
TAKE-OFF AND LANDING
WITH SEAT BACK UPRIGHT
AND AFT FACING SEATS
MUST HAVE HEADREST
FULLY EXTENDED**

*On Inside of Utility Door, on Left Sidewall of Utility
Compartment, or on Aft Bulkhead:*

BAGGAGE COMPARTMENTS
**LOAD IN ACCORDANCE WITH
WEIGHT AND BALANCE DATA**
— MAXIMUM STRUCTURAL CAPACITY
MAIN COMPARTMENT — 400 POUNDS
AFT COMPARTMENT — 120 POUNDS

**Section II
Limitations**

**BEECHCRAFT Baron 58
Serial TH 773 and After**

*On Left Sidewall of Utility Compartment or Aft Bulkhead
(with utility door removal kit):*

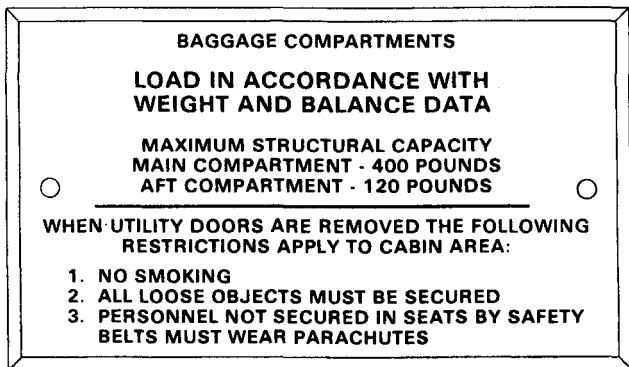

On Floating Panel when Utility Doors are Removed:



*In Plain View When Nose Baggage Compartment Door Is
Open:*



On Control Lock

INSTALLATION INSTRUCTIONS

INSTALL OTHER SIDE FACING PILOT

- 1. CLOSE THROTTLES, INSTALL PIN BETWEEN LEVERS, THROUGH COLLAR LOCK & CONTROL COLUMN. (ROTATE CONTROL WHEEL APPROX 12° TO THE RIGHT)**
- 2. ROUTE CABLE & RUDDER LOCK AROUND RIGHT SIDE OF CONTROL COLUMN, POSITION PEDALS IN AFT POSITION & INSTALL LOCK IN RUDDER PEDALS.**

**CONTROLS LOCKED
REMOVE BEFORE
FLIGHT**

KINDS OF OPERATIONS EQUIPMENT LIST

This airplane may be operated in day or night VFR, day or night IFR when the appropriate equipment is installed and operable.

The following equipment list identifies the systems and equipment upon which type certification for each kind of operation was predicated. The following systems and items of equipment must be installed and operable for the particular kind of operation indicated unless:

1. The airplane is operated in accordance with a current Minimum Equipment List (MEL) issued by the FAA.

Or:

2. An alternate procedure is provided in the Pilot's Operating Handbook and FAA Approved Airplane Flight Manual for the inoperative state of the listed equipment.

Numbers on the Kinds of Operations Equipment List refer to quantities required to be operative for a specified condition.

NOTE

The following Kinds of Operations Equipment List does not include all specific flight instruments and communications/navigation equipment required by the FAR Part 91 and 135 Operating Requirements. It also does not include components obviously required for the airplane to be airworthy such as wings, empennage, engines, etc.

**Section II
Limitations**

**BEECHCRAFT Baron 58
Serial TH 773 and After**

SYSTEM and/or COMPONENT	VFR DAY				VFR NIGHT		IFR DAY		IFR NIGHT	
ELECTRICAL POWER										
Battery	1	1	1	1	1	1	1	1	1	2
DC Alternator	2	2	2	2	2	2	2	2	2	2
DC Loadmeter	2	2	2	2	2	2	2	2	2	2
Alternator-Out Light	2	2	2	2	2	2	2	2	2	2
Starter Energized	1	1	1	1	1	1	1	1	1	1
Warning Light (TH-1194 and after)										
ENGINE INDICATING INSTRUMENTS										
Engine Tachometer (Dual Indicating)	1	1	1	1	1	1	1	1	1	2
Manifold Pressure Indicator (Dual Indicating)	1	1	1	1	1	1	1	1	1	2
Cylinder Head Temp Gage	2	2	2	2	2	2	2	2	2	2

**Section II
Limitations**

**BEECHCRAFT Baron 58
Serial TH 773 and After**

SYSTEM and/or COMPONENT	VFR DAY	VFR NIGHT	IFR DAY	IFR NIGHT
ENGINE OIL				
Oil Pressure Indicator	2	2	2	2
Oil Temperature Indicator	2	2	2	2
FLIGHT CONTROLS				
Trim Tab Indicators (Rudder, Aileron, and Elevator)	3	3	3	3
Flap System	1	1	1	1
Flap Position Indicator	1	1	1	1
Stall Warning System	1	1	1	1

FLIGHT INSTRUMENTS					
Altimeter	1	1	1	1	1
Airspeed Indicator	1	1	1	1	1
Magnetic Compass	1	1	1	1	1
Attitude Indicator	0	0	0	0	0
Turn and Slip Indicator	0	0	0	0	0
Directional Gyro	0	0	0	0	0
Clock	0	0	0	0	0
Outside Air Temperature Indicator	1	1	1	1	1
FUEL EQUIPMENT					
Engine Driven Fuel Pump	2	2	2	2	2
Electrically Driven Aux Fuel Pump	2	2	2	2	2
Fuel Quantity Indicator	2	2	2	2	2
Fuel Flow Indicator	1	1	1	1	1
Fuel Selector Valve	2	2	2	2	2
ICE AND RAIN PROTECTION					
Emergency Static Air System (If Installed)	0	0	0	0	0
Pitot Heater	0	0	0	0	0
Heated Fuel Vent	0	0	0	0	0

**Section II
Limitations**

**BEECHCRAFT Baron 58
Serial TH 773 and After**

SYSTEM and/or COMPONENT	VFR DAY		VFR NIGHT		IFR DAY		IFR NIGHT	
LIGHTS								
Cockpit and Instrument Light System	0	1	0	0	1	0	1	
Landing Light	0	2	0	0	2	0	2	
Landing Light (With Opt Wing Tip Fuel Tanks TH-773 thru TH-873)	0	1	0	0	1	0	1	
Landing Light (With Opt Wing Tip Fuel Tanks TH-874 and after)	0	2	0	0	2	0	2	
Rotating Beacon	0	1	0	0	1	0	1	
Navigation Light	0	3	0	0	3	0	3	

LANDING GEAR					
Landing Gear Motor and Gearbox	1	1	1	1	1
Landing Gear Position Indicating Lights	4	4	4	4	4
Landing Gear Aural Warning Horn	1	1	1	1	1
Emergency Landing Gear Extension System	1	1	1	1	1
PNEUMATIC SYSTEM					
Instrument Air System	0	2	2	2	2
Pressure Gage	0	1	1	1	1
PUBLICATIONS					
Pilot's Operating Handbook and FAA Approved Airplane Flight Manual	1	1	1	1	1

**Section II
Limitations**

**BEECHCRAFT Baron 58
Serial TH 773 and After**

SYSTEM and/or COMPONENT	VFR DAY			
	VFR NIGHT	IFR DAY		
		IFR NIGHT		
RESTRAINT SYSTEM				
Seat Belts (Per Seat)	1	1	1	1
Shoulder Harness (Per Seat)	1	1	1	1

SECTION III

EMERGENCY PROCEDURES

TABLE OF CONTENTS

<i>SUBJECT</i>	<i>PAGE</i>
Emergency Airspeeds (5400 LBS).....	3-3
One Engine Operation	3-3
Determining Inoperative Engine.....	3-4
One-Engine Inoperative Procedures.....	3-4
Engine Failure During Take-Off.....	3-4
Engine Failure After Lift-off and In Flight.....	3-5
Air Start.....	3-6
Engine Fire (Ground)	3-7
Engine Fire In Flight	3-7
Emergency Descent	3-7
Glide	3-8
Landing Emergencies	3-8
Gear Up Landing	3-8
One-Engine Inoperative Landing.....	3-9
One-Engine Inoperative Go-Around.....	3-9
Systems Emergencies	3-10
One-Engine Inoperative Operation on Crossfeed.....	3-10
Electrical Smoke or Fire	3-10
Starter Energized Warning Light Illuminated	3-11
Illumination of Alternator-Out Light (TH-773 thru TH-1376).....	3-11
Illumination of Alternator-Out Light (TH-1377 and After, and Airplanes Equipped With Kit No. 55-3024).....	3-12
Unscheduled Electric Elevator Trim	3-12A
Landing Gear Manual Extension	3-13

TABLE OF CONTENTS (Continued)

<i>SUBJECT</i>	<i>PAGE</i>
Landing Gear Retraction After Practice Manual Extension.....	3-13
Ice Protection.....	3-14
Surface Deice System.....	3-14
Electrothermal Propeller Deice System	3-14
Emergency Static Air Source	3-15
Emergency Exits	3-16
Unlatched Door in Flight	3-17
Simulated One-Engine Inoperative	3-17
Spins.....	3-18

All airspeeds quoted in this section are indicated airspeeds (IAS) and assume zero instrument error.

EMERGENCY AIRSPEEDS (5400 LBS)

One-Engine-Inoperative Best	
Angle-of-Climb (V_X)	96 kts
One-Engine-Inoperative Best	
Rate-of-Climb (V_Y)	100 kts
Air Minimum Control Speed (V_{MCA})	81 kts
One-Engine-Inoperative Enroute Climb	100 kts
Emergency Descent	152 kts
One-Engine-Inoperative Landing:	
Maneuvering to Final Approach	100 kts
Final Approach (Flaps Down)	100 kts
Intentional One-Engine-Inoperative	
Speed (V_{SSE})	86 kts
Maximum Glide Range	120 kts

On Serials TH-973 and After, the stall warning horn is inoperative when the battery and alternator switches are turned off.

The following information is presented to enable the pilot to form, in advance, a definite plan of action for coping with the most probable emergency situations which could occur in the operation of the airplane. Where practicable, the emergencies requiring immediate corrective action are treated in check list form for easy reference and familiarization. Other situations, in which more time is usually permitted to decide on and execute a plan of action, are discussed at some length. In order to supply one safe speed for each type of emergency situation, the airspeeds presented were derived at 5400 lbs.

ONE ENGINE OPERATION

Two major factors govern one engine operations; airspeed and directional control. The airplane can be safely maneu-

vered or trimmed for normal hands-off operation and sustained in this configuration by the operative engine AS LONG AS SUFFICIENT AIRSPEED IS MAINTAINED.

DETERMINING INOPERATIVE ENGINE

The following checks will help determine which engine has failed.

1. **DEAD FOOT - DEAD ENGINE.** The rudder pressure required to maintain directional control will be on the side of the good engine.
2. **THROTTLE.** Partially retard the throttle for the engine that is believed to be inoperative; there should be no change in control pressures or in the sound of the engine if the correct throttle has been selected. **AT LOW ALTITUDE AND AIRSPEED THIS CHECK MUST BE ACCOMPLISHED WITH EXTREME CAUTION.**

Do not attempt to determine the inoperative engine by means of the tachometers or the manifold pressure gages. These instruments often indicate near normal readings.

ONE-ENGINE INOPERATIVE PROCEDURES

ENGINE FAILURE DURING TAKE-OFF

1. Throttles - **CLOSED**
2. Braking - **MAXIMUM**

If insufficient runway remains for stopping:

3. Fuel Selector Valves - **OFF**
4. Battery, Alternator, and Magneto/Start Switches - **OFF**

**ENGINE FAILURE AFTER LIFT-OFF
AND IN FLIGHT**

NOTE

The most important aspect of engine failure is the necessity to maintain lateral and directional control. If airspeed is below 81 kts, reduce power on the operative engine as required to maintain control.

An immediate landing is advisable regardless of take-off weight. Continued flight cannot be assured if take-off weight exceeds the weight determined from the TAKE-OFF WEIGHT graph. Higher take-off weights will result in a loss of altitude while retracting the landing gear and feathering the propeller. Continued flight requires immediate pilot response to the following procedures.

1. Landing Gear and Flaps - UP
2. Throttle (inoperative engine) - CLOSED
3. Propeller (inoperative engine) - FEATHER
4. Power (operative engine) - AS REQUIRED
5. Airspeed - MAINTAIN SPEED AT ENGINE FAILURE (100 KTS MAX.) UNTIL OBSTACLES ARE CLEARED.

After positive control of the airplane is established:

6. Secure inoperative engine:
 - a. Mixture Control - IDLE CUT-OFF
 - b. Fuel Selector - OFF
 - c. Auxiliary Fuel Pump - OFF
 - d. Magneto/Start Switch - OFF
 - e. Alternator Switch - OFF
 - f. Cowl Flap - CLOSED
7. Electrical Load - MONITOR (Maximum load of 1.0 on remaining engine)

AIR START

CAUTION

The pilot should determine the reason for engine failure before attempting an air start.

1. Fuel Selector Valve - ON
2. Throttle - SET approximately 1/4 travel
3. Mixture Control - FULL RICH, below 5000 ft (1/2 travel above 5,000 ft)
4. Aux Fuel Pump - LOW
5. Magnetos - CHECK ON
6. Propeller:

WITH UNFEATHERING ACCUMULATORS:

- a. Move propeller control full forward to accomplish unfeathering. Use starter momentarily if necessary.
- b. Return control to high pitch (low rpm) position, when windmilling starts, to avoid overspeed.

If propeller does not unfeather or engine does not turn, proceed to WITHOUT UNFEATHERING ACCUMULATORS procedure.

WITHOUT UNFEATHERING ACCUMULATORS:

- a. Move propeller control forward of the feathering detent to midrange.
- b. Engage Starter to accomplish unfeathering.
- c. If engine fails to run, clear engine by allowing it to windmill with mixture in IDLE CUT-OFF. When engine fires, advance mixture to FULL RICH.

7. When Engine Starts - ADJUST THROTTLE, PROPELLER and MIXTURE CONTROLS
8. Aux Fuel Pump - OFF (when reliable power has been regained)

9. Alternator Switch - ON
10. Oil Pressure - CHECK
11. Warm Up Engine (approximately 2000 rpm and 15 in. Hg)
12. Set power as required and trim

ENGINE FIRE (GROUND)

1. Mixture Controls - IDLE CUT-OFF
2. Continue to crank affected engine
3. Fuel Selector Valves - OFF
4. Battery and Alternator Switches - OFF
5. Extinguish with Fire Extinguisher

ENGINE FIRE IN FLIGHT

Shut down the affected engine according to the following procedure and land immediately. Follow the applicable single-engine procedures in this section.

1. Fuel Selector Valve - OFF
2. Mixture Control - IDLE CUT-OFF
3. Propeller - FEATHERED
4. Aux Fuel Pump - OFF
5. Magneto/Start Switch - OFF
6. Alternator Switch - OFF

EMERGENCY DESCENT

1. Propellers - 2700 RPM
2. Throttles - CLOSED
3. Airspeed - 152 kts
4. Landing Gear - DOWN
5. Flaps - APPROACH (15°)

GLIDE

1. Propellers - FEATHER
2. Flaps - UP
3. Landing Gear - UP
4. Cowl Flaps - CLOSED

The glide ratio in this configuration is approximately 2 nautical miles of gliding distance for each 1000 feet of altitude above the terrain at an airspeed of 120 kts.

LANDING EMERGENCIES

GEAR-UP LANDING

If possible, choose firm sod or foamed runway. When assured of reaching landing site:

1. Cowl Flaps - CLOSED
2. Wing Flaps - AS DESIRED
3. Throttles - CLOSED
4. Fuel Selectors - OFF
5. Mixture Controls - IDLE CUT-OFF
6. Battery, Alternator and Magneto/Start Switches - OFF
7. Keep wings level during touchdown.
8. Get clear of the airplane as soon as possible after it stops.

NOTE

The gear up landing procedures are based on the best available information and no actual tests have been conducted.

ONE-ENGINE-INOPERATIVE LANDING

On final approach and when it is certain that the field can be reached:

1. Landing Gear - DOWN
2. Flaps - APPROACH (15°)
3. Airspeed - 100 kts
4. Power - AS REQUIRED to maintain 800 ft/min rate of descent

When it is certain there is no possibility of go-around:

5. Flaps - DOWN (30°)
6. Execute normal landing

ONE-ENGINE-INOPERATIVE GO-AROUND

WARNING

Level flight might not be possible for certain combinations of weight, temperature and altitude. In any event, **DO NOT** attempt a one engine inoperative go-around after flaps have been fully extended.

1. Power - MAXIMUM ALLOWABLE
2. Landing Gear - UP
3. Flaps - UP (0°)
4. Airspeed - MAINTAIN 100 KTS

SYSTEMS EMERGENCIES

ONE-ENGINE INOPERATIVE OPERATION ON CROSSFEED

NOTE

The fuel crossfeed system is to be used only during emergency conditions in level flight only.

Left engine inoperative:

1. Right Aux Fuel Pump - LOW
2. Left Fuel Selector Valve - OFF
3. Right Fuel Selector Valve - CROSSFEED
4. Right Aux Fuel Pump - LOW or OFF as required

Right engine inoperative:

1. Left Aux Fuel Pump - LOW
2. Right Fuel Selector Valve - OFF
3. Left Fuel Selector Valve - CROSSFEED
4. Left Aux Fuel Pump - LOW or OFF as required

ELECTRICAL SMOKE OR FIRE

Action to be taken must consider existing conditions and equipment installed:

1. Battery and Alternator Switches - OFF

WARNING

Electrically driven flight instruments will become inoperative.

2. Oxygen - AS REQUIRED
3. All Electrical Switches - OFF
4. Battery and Alternator Switches - ON

5. Essential Electrical Equipment - ON (Isolate defective equipment)

NOTE

Ensure fire is out and will not be aggravated by draft. Turn off CABIN HEAT switch and push in the CABIN AIR control. Open pilot's storm window, if required.

STARTER ENERGIZED WARNING LIGHT ILLUMINATED
(If installed)

After engine start, should the starter relay remain engaged, the starter will remain energized and the starter energized warning light will remain illuminated. Continuing to supply power to the starter will result in eventual loss of electrical power.

ON THE GROUND:

1. Battery Master and both Alternator Switches - OFF.
2. Do not take off.

IN FLIGHT AFTER AIR START

1. Battery Master and both Alternator Switches - OFF.
2. Land as soon as practical.

ILLUMINATION OF ALTERNATOR OUT LIGHT (TH-773 thru TH-1376)

In the event of the illumination of a single ALTERNATOR OUT light:

1. Check the respective loadmeter for load indication
 - a. No Load - Turn off affected alternator
 - b. Regulate load

In the event of the illumination of both ALTERNATOR OUT lights:

1. Check loadmeters for load indication
 - a. No load indicates failure of regulator
 - (1) Switch regulators
 - (2) System should indicate normal

- b. If condition recurs
 - (1) Switch to original regulator
 - (2) System returns to normal, indicates overload condition causing malfunction
 - (3) Reduce load
- c. If condition indicates malfunction of both alternator circuits
 - (1) Both ALT Switches - OFF
 - (2) Minimize electrical load since only battery power will be available

ILLUMINATION OF ALTERNATOR - OUT LIGHT (TH-1377 AND AFTER, AND AIRPLANES EQUIPPED WITH KIT NO. 55-3024)

In the event of the illumination of a single ALTERNATOR - OUT light:

- 1. Check the respective loadmeter for load indication.
 - a. No Load - Turn off affected alternator.
 - b. Regulate load to less than 100% of remaining alternator.
 - c. Affected Alternator - ON. Check load indication.
 - d. No Load - Turn affected alternator off and leave off.

In the event of the illumination of both ALTERNATOR - OUT lights:

- 1. Check loadmeters for load indication.
 - a. No Load - Turn both alternator switches off.
 - b. Reduce load to minimum (must be less than the rating of one alternator).
 - c. Left Alternator - ON. If no indication on loadmeter, turn off and leave off.

- d. Right Alternator - ON. If no indication on loadmeter, turn off and leave off.
 - e. Adjust electrical load.
2. If condition indicates malfunction of both alternator circuits:
 - a. Both ALT switches - OFF.
 - b. Minimize electrical load since only battery power will be available.

UNSCHEDULED ELECTRIC ELEVATOR TRIM

Incorporated in the system is an emergency release button located on the left handle grip of the pilot's control wheel. This button can be depressed to deactivate the system quickly in case of a malfunction in the system. The system will remain deactivated only while the release button is being held in the depressed position.

1. Airplane Attitude - MAINTAIN using elevator control
2. Trim Release (under pilot's thumb adjacent to control wheel trim switch) - HOLD IN DEPRESSED POSITION
3. Trim - MANUALLY RE-TRIM AIRPLANE
4. Electric Trim - OFF
5. Trim Release - RELEASE
6. Circuit Breaker - PULL

NOTE

Do not attempt to operate the electric trim system until the cause of the malfunction has been determined and corrected.

INTENTIONALLY LEFT BLANK

LANDING GEAR MANUAL EXTENSION

Reduce airspeed before attempting manual extension of the landing gear.

1. LDG GR MOTOR Circuit Breaker - PULL
2. Landing Gear Handle - DOWN
3. Remove cover from handcrank at rear of front seats. Engage handcrank and turn counterclockwise as far as possible (approximately 50 turns). Stow handcrank.
4. If electrical system is operative, check landing gear position lights and warning horn (check LDG GR RELAY circuit breaker engaged.)

CAUTION

The manual extension system is designed only to lower the landing gear; do not attempt to retract the gear manually.

WARNING

Do not operate the landing gear electrically with the handcrank engaged, as damage to the mechanism could occur.

After emergency landing gear extension, do not move any landing gear controls or reset any switches or circuit breakers until airplane is on jacks, as failure may have been in the gear-up circuit and gear might retract with the airplane on the ground.

LANDING GEAR RETRACTION AFTER PRACTICE MANUAL EXTENSION

After practice manual extension of the landing gear, the gear may be retracted electrically, as follows:

1. Handcrank - CHECK, STOWED
2. Landing Gear Motor Circuit Breaker - IN
3. Landing Gear Handle - UP

ICE PROTECTION

SURFACE DEICE SYSTEM

- a. Failure of AUTO Operation
 - (1) Surface Deice Switch - MANUAL (Do not hold more than 8 seconds)

CAUTION

The boots will inflate only as long as the switch is held in the MANUAL position. When the switch is released the boots will deflate.

- b. Failure of boots to deflate
 - (1) Pull circuit breaker on pilot's side panel.

ELECTROTHERMAL PROPELLER DEICE SYSTEM

- 1. Loss of one alternator; turn off unnecessary electrical equipment. Turn the prop deice system off while operating the cabin heater blower or the landing gear motor. Monitor electrical loads so as not to exceed alternator capacity of 1.0 on the loadmeter.

An abnormal reading on the Propeller Deice Ammeter indicates need for the following action:

- a. Zero Amps:

Check prop deice circuit breaker. If the circuit breaker has tripped, a wait of approximately 30 seconds is necessary before resetting. If ammeter reads 0 and the circuit breaker has not tripped or if the ammeter still reads 0 after the circuit breaker has been reset, turn the switch off and consider the prop deice system inoperative.

- b. Zero to 7 Amps, 2 Blade Propeller; Zero to 14 Amps, 3 Blade Propeller:

If the prop deice system ammeter occasionally or regularly indicates less than 7 amps for 2 blade, (or 14 amps for 3 blade), operation of the prop deice system can continue unless serious propeller imbalance results from irregular ice throw-offs.

- c. 12 to 15 Amps, 2 Blade Propeller; 18 to 23 Amps, 3 Blade Propeller:

If the prop deicing system ammeter occasionally or regularly indicates 12 to 15 amps for 2 blade (or 18 to 23 amps for 3 blade), operation of the prop deice system can continue unless serious propeller imbalance results from irregular ice throw-offs.

- d. More than 15 Amps, 2 Blade Propeller, More than 23 amps, 3 Blade Propeller:

If the prop deice system ammeter occasionally or regularly indicates more than 15 amps for 2 blade, or more than 23 amps for 3 blade, the system should not be operated unless the need for prop deicing is urgent.

EMERGENCY STATIC AIR SOURCE SYSTEM

THE EMERGENCY STATIC AIR SOURCE SHOULD BE USED FOR CONDITIONS WHERE THE NORMAL STATIC SOURCE HAS BEEN OBSTRUCTED. When the airplane has been exposed to moisture and/or icing conditions (especially on the ground), the possibility of obstructed static ports should be considered. Partial obstructions will result in the rate of climb indication being sluggish during a climb or descent.

Verification of suspected obstruction is possible by switching to the emergency system and noting a sudden sustained change in rate of climb. This may be accompanied by abnormal indicated airspeed and altitude changes beyond normal calibration differences.

Whenever any obstruction exists in the Normal Static Air System or the Emergency Static Air System is desired for use:

1. Emergency Static Air Source - Switch to ON EMERGENCY. (lower sidewall adjacent to pilot)
2. For Airspeed Calibration and Altimeter Corrections, refer to the PERFORMANCE section.

CAUTION

The emergency static air valve should remain in the OFF NORMAL position when system is not needed.

EMERGENCY EXITS

Emergency exits, provided by the openable window on each side of the cabin, may be used for egress in addition to the cabin door and the utility door.

NOTE

For access past the 3rd and/or 4th seats, rotate the red handle, located on the lower inboard side of the seat back, and fold the seat back over.

To Open Each Emergency Exit:

Serials TH-773 thru TH-1079, Except TH-1027, TH-1062, and TH-1067:

An emergency exit placard is installed below the left and right openable windows.

1. Lift the latch.
2. Pull out the emergency release pin and push the window out.

Serials TH-1027, TH-1062, TH-1067, TH-1080 and After:

1. Remove cover as indicated by placard in the center of the Ventilation/Emergency Exit latch.
2. Rotate handle up as indicated by placard, breaking safety wire, and push window out.

NOTE

Anytime the window has been opened by breaking the safety wire on the red emergency latch, the window must be reattached and wired by a qualified mechanic using QQ-W-343, Type S, .020 diameter copper wire prior to further airplane operation.

UNLATCHED DOOR IN FLIGHT

If the cabin door is not locked it may come unlatched in flight. This may occur during or just after take-off. The door will trail in a position approximately 3 to 4 inches open. Flight characteristics of the airplane will not be affected

except for a reduction in performance. Return to the field in a normal manner. If practicable, during the landing flare-out have a passenger hold the door to prevent it from swinging open.

SIMULATED ONE ENGINE INOPERATIVE

ZERO THRUST (Simulated Feather)

Use the following power setting (only on one engine at a time) to establish zero thrust. Use of this power setting avoids the difficulties of restarting an engine and preserves the availability of engine power.

The following procedure should be accomplished by alternating small reductions of propeller and then throttle, until the desired setting has been reached.

1. Propeller Lever - RETARD TO FEATHER DETENT
2. Throttle Lever - SET 12 in. Hg MANIFOLD PRESSURE

NOTE

This setting will approximate Zero Thrust using recommended One-Engine Inoperative Climb speeds.

SPINS

If a spin is entered inadvertently:

Immediately move the control column full forward, apply full rudder opposite to the direction of the spin and reduce power on both engines to idle. These three actions should

be done as near simultaneously as possible; then continue to hold this control position until rotation stops and then neutralize all controls and execute a smooth pullout. Ailerons should be neutral during recovery.

NOTE

Federal Aviation Administration Regulations do not require spin demonstration of airplanes of this weight; therefore, no spin tests have been conducted. The recovery technique is based on the best available information.

SECTION IV

NORMAL PROCEDURES

TABLE OF CONTENTS

<i>SUBJECT</i>	<i>PAGE</i>
Airspeeds for Safe Operation (5400 LBS)	4-3
Preflight Inspection	4-4
Before Starting.....	4-6
Starting	4-7
After Starting and Taxi	4-8B
Before Takeoff	4-9
Takeoff.....	4-10
Maximum Performance Climb.....	4-10
Cruise Climb	4-10
Normal Operating Power Climb	4-10A
Cruise	4-10A
Leaning Using the Exhaust Gas	
Temperature Indicator	4-10A
Descent	4-12
Before Landing	4-12
Balked Landing	4-13
After Landing	4-13
Shutdown.....	4-13
Oxygen System	4-14
Electric Elevator Trim.....	4-16
Cold Weather Operation	4-17
Preflight Inspection.....	4-17
Engines	4-17
External Power.....	4-19
Starting Engines Using	
Auxiliary Power Unit.....	4-20
Taxiing	4-20
August, 1984	4-1

TABLE OF CONTENTS (Continued)

<i>SUBJECT</i>	<i>PAGE</i>
Ice Protection Systems	4-21
Emergency Static Air Source	4-21
Surface Deice System	4-22
Electrothermal Propeller Deice	4-22A
Windshield Anti-ice System (Electrothermal)	4-23
Propeller and Windshield Anti-ice System (Fluid Flow)	4-24
Pitot Heat and Heated Stall Warning	4-24
Fuel Vent Heat	4-25
Windshield Defogging	4-25
Engine Break-In Information	4-25
Practice Demonstration of V_{MCA}	4-25
Noise Characteristics	4-26

All airspeeds quoted in this section are indicated airspeeds (IAS) and assume zero instrument error.

AIRSPEEDS FOR SAFE OPERATION (5400 LBS)

Maximum Demonstrated Crosswind	
Component	22 kts
Takeoff:	
Lift-off	86 kts
50-ft Speed	94 kts
Two-Engine Best Angle-of-Climb (V_X)	86 kts
Two-Engine Best Rate-of-Climb (V_Y)	104 kts
Cruise Climb	139 kts
Turbulent Air Penetration	156 kts
Landing Approach:	
Flaps DN	96 kts
Balked Landing Climb	96 kts
Intentional One-Engine-Inoperative	
Speed (V_{SSE})	86 kts
Air Minimum Control Speed (V_{MCA})	81 kts

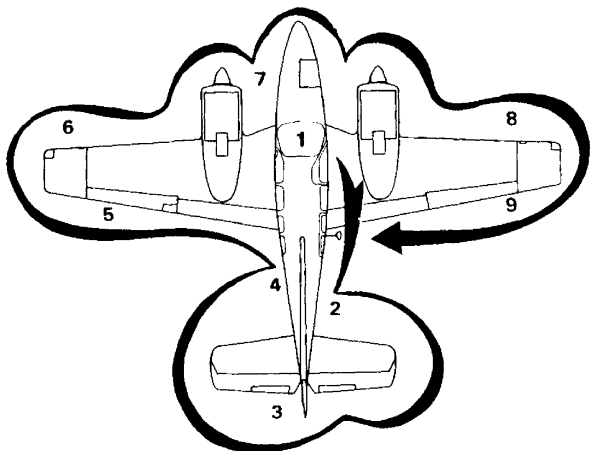

NOTE

Refer to all applicable Beech Supplements and STC Supplements for flight phase procedures for optional equipment installed in the airplane.

PREFLIGHT INSPECTION

1. COCKPIT:

- a. Control Lock - REMOVE AND STOW
- b. Parking Brake - SET
- c. All Switches - OFF
- d. Trim Tabs - SET TO ZERO

2. RIGHT FUSELAGE:

- a. Load Distribution - CHECK AND SECURED
- b. Utility Door - SECURE
- c. Static Port - UNOBSTRUCTED
- d. Emergency Locator Transmitter - ARMED

3. EMPENNAGE:

- a. Control Surfaces, Tabs and Deice Boots - CHECK
CONDITION, SECURITY, AND ATTACHMENT
- b. Tail Cone, Tail Light, and Rudder Beacon - CHECK
- c. Tie Down - REMOVE
- d. Cabin Air Inlet - CHECK

4. LEFT FUSELAGE:
 - a. Cabin Air Outlet - CHECK
 - b. Static Port - UNOBSTRUCTED
 - c. All Antennas and Lower Beacon - CHECK

5. LEFT WING TRAILING EDGE:
 - a. Fuel Sump Aft of Wheel Well - DRAIN
 - b. Fuel Vents - CHECK
 - c. Flaps - CHECK GENERAL CONDITION
 - d. Aileron - CHECK CONDITION AND FREEDOM OF MOVEMENT, TAB NEUTRAL WHEN AILERON NEUTRAL

6. LEFT WING LEADING EDGE
 - a. Lights and Deice Boot - CHECK FOR CONDITION
 - b. Stall Warning Vane - CHECK FREEDOM OF MOVEMENT
 - c. Fuel - CHECK QUANTITY AND CAP(S) SECURE. ALWAYS CHECK WING TIP TANK FIRST (IF INSTALLED); DO NOT REMOVE INBOARD CAP IF FUEL IS VISIBLE IN TIP TANK.
 - d. Wing Tip Tank (if installed) Sump - DRAIN
 - e. Fuel Sight Gage - CHECK
 - f. Tie Down, Chocks - REMOVE
 - g. Engine Oil - CHECK QUANTITY, CAP AND DOOR SECURE
 - h. Engine Cowling and Doors - CHECK CONDITION AND SECURITY
 - i. Landing Light (if installed) - CHECK
 - j. Engine Air Intake - REMOVE COVER AND EXAMINE FOR OBSTRUCTIONS

INTENTIONALLY LEFT BLANK

- k. Propeller - EXAMINE FOR NICKS, SECURITY AND OIL LEAKS
- l. Cowl Flap - CHECK
- m. Wheel Well Doors, Tire, Brake Line and Shock Strut - CHECK
- n. Landing Gear Uplock Roller - CHECK
- o. Fuel Drains - DRAIN

7. NOSE SECTION

- a. Wheel Well Doors, Tire and Shock Strut - CHECK
- b. Pitot(s) - REMOVE COVER, EXAMINE FOR OBSTRUCTIONS
- c. Taxi Light - CHECK (if installed)
- d. Heater Air Inlets - CLEAR
- e. Oxygen - CHECK
- f. Baggage Door - SECURE

8. RIGHT WING LEADING EDGE

- a. Wheel Well Doors, Tire, Brake Line, and Shock Strut - CHECK
- b. Landing Gear Uplock Roller - CHECK
- c. Cowl Flap - CHECK
- d. Fuel Drains - DRAIN
- e. Engine Oil - CHECK QUANTITY, CAP AND DOOR SECURE
- f. Engine Cowling and Doors - CHECK CONDITION AND SECURITY
- g. Landing Light (if installed) - CHECK
- h. Propeller - EXAMINE FOR NICKS, SECURITY, AND OIL LEAKS
- i. Engine Air Intake - REMOVE COVER AND EXAMINE FOR OBSTRUCTIONS
- j. Fuel Sight Gage - CHECK
- k. Fuel - CHECK QUANTITY AND CAP(S) SECURE. ALWAYS CHECK WING TIP TANK FIRST (IF INSTALLED); DO NOT REMOVE INBOARD CAP IF FUEL IS VISIBLE IN TIP TANK.

Section IV
Normal Procedures

BEECHCRAFT Baron 58
Serial TH-773 and After

- l. Wing Tip Tank (if installed) Sump - DRAIN
 - m. Tie Down and Chocks - REMOVE
 - n. Lights and Deice Boot - CHECK FOR CONDITION
9. RIGHT WING TRAILING EDGE
- a. Aileron - CHECK CONDITION AND FREEDOM OF MOVEMENT
 - b. Fuel Vents - CHECK
 - c. Fuel Sump Aft of Wheel Well - DRAIN
 - d. Flaps - CHECK GENERAL CONDITION

NOTE

Check operation of lights if night flight is anticipated.

CAUTION

DO NOT TAXI WITH A FLAT SHOCK STRUT.

BEFORE STARTING

- 1. Seats - POSITION AND LOCK SEAT BACKS UPRIGHT
- 2. Seat Belts and Shoulder Harnesses - FASTEN
- 3. Parking Brakes - SET
- 4. All Avionics - OFF
- 5. Oxygen - CHECK QUANTITY AND OPERATION
- 6. Landing Gear Handle - DOWN
- 7. Cowl Flaps - CHECK, OPEN
- 8. Fuel Selector Valves - CHECK OPERATION THEN ON

9. All Circuit Breakers, Switches and Equipment Controls - CHECK
10. Battery and Alternator Switches - ON (if external power is to be used, Alternator Switches - OFF)

11. Fuel Quantity Indicators - CHECK QUANTITY (See LIMITATIONS for take-off fuel)
12. Landing Gear Position Lights - CHECK

STARTING

1. Throttle Position - APPROXIMATELY 1 2 IN. OPEN
2. Propeller Control - LOW PITCH (high rpm)
3. Mixture Control - FULL RICH

NOTE

If the engine is hot, and the ambient temperature is 90°F or above, place mixture control in IDLE CUT-OFF, switch aux fuel pump to HIGH for 30 to 60 seconds, then OFF. Return mixture control to FULL RICH.

4. Aux Fuel Pump - HIGH (until fuel flow stabilizes then - OFF)
5. Magneto/Start Switch - START (Observe Starter Limits)

CAUTION

Do not engage starter for more than 30 seconds in any 4-minute time period.

NOTE

In the event of a balked start (or overprime condition) place mixture control in IDLE CUT-OFF and open the throttle; operate the starter to remove excess fuel. As engine starts, reduce the throttle to idle rpm and place the mixture control in FULL RICH.

6. Warm-up - 1000 to 1200 RPM
7. Oil Pressure - 25 PSI WITHIN 30 SECONDS
8. External Power (if used) - DISCONNECT

WARNING

When using external power, start the right engine first, since the external power receptacle is on the left nacelle. Disconnect external power before starting left engine.

9. Alternator Switch - ON
10. All Engine Indicators - CHECK
11. Starter Energized Warning Light (if installed) - CHECK for illumination during initial start. Should not be illuminated after starting.

CAUTION

If the starter energized warning light is not installed, or is inoperative and the total of both loadmeters exceeds .2 after two minutes at 1000-1200 rpm, with no additional electrical equipment on, and the indication shows no signs of decreasing, an electrical malfunction is indicated. The battery master and both alternator switches should be placed in the OFF position. Do not take off.

CAUTION

Low voltage, high ammeter or loadmeter readings, dimming of lights, or excessive noise in radio receivers could be indications that problems are developing in the starter system. A noted change in such normal conditions could indicate prolonged starter motor running and the engine should be shut down. No further flight operations should be attempted until the cause is determined and repaired.

12. Using the same procedure, start other engine.

AFTER STARTING AND TAXI

CAUTION

Do not operate engine above 1200 RPM until oil temperature reaches 75°F.

1. Brakes - RELEASE AND CHECK
2. Avionics - ON, AS REQUIRED
3. Exterior Lights - AS REQUIRED

BEFORE TAKEOFF

1. Parking Brake - SET
2. Seat Belts and Shoulder Harnesses - CHECK
3. Aux Fuel Pumps - OFF (If ambient temperature is 90°F or above, use LOW pressure boost)
4. All Instruments - CHECKED
5. Fuel Indicators - CHECK QUANTITY
6. Mixture - FULL RICH (or as required by field elevation)
7. Propellers - EXERCISE AT 2200 RPM

CAUTION

When exercising propellers in their governing range, do not move the control lever aft past the detent. To do so will allow the propeller to change rapidly to the full feathered position, imposing high stresses on the blade shank and engine.

8. Starter Energized Warning Light (if installed) - CHECK; should be illuminated during start and extinguished after start. If light is not installed or is inoperative, check loadmeters for proper indication.
9. Throttles - 1700 RPM
10. Magnetos - CHECK (Variance between individual magnetos should not exceed 50 rpm, max. drop 150 rpm)
11. Throttles - 1500 RPM
12. Propellers - FEATHERING CHECK (Do not allow an rpm drop of more than 500 rpm)
13. Throttles - IDLE
14. Electric Trim - CHECK OPERATION

Section IV
Normal Procedures

BEEHCRAFT Baron 58
Serial TH 773 and After

15. Trim - AS REQUIRED FOR TAKEOFF
16. Flaps - CHECK AND SET FOR TAKEOFF
17. Flight Controls - CHECK PROPER DIRECTION, AND FREEDOM OF MOVEMENT
18. Doors and Windows - LOCKED
19. Parking Brake - OFF

TAKEOFF

Take-Off Power Full throttle, 2700 rpm

Minimum Take-Off Oil Temperature 75°F

1. Power - SET TAKE-OFF POWER (MIXTURE - SET FUEL FLOW TO ALTITUDE) BEFORE BRAKE RELEASE
2. Airspeed - ACCELERATE TO AND MAINTAIN RECOMMENDED SPEED
3. Landing Gear - RETRACT (when positive rate of climb is established)
4. Airspeed - ESTABLISH DESIRED CLIMB SPEED (when clear of obstacles)

MAXIMUM PERFORMANCE CLIMB (TH-773 thru TH-1089)

1. Power - SET MAXIMUM CONTINUOUS POWER
2. Mixtures - LEAN TO APPROPRIATE FUEL FLOW
3. Cowl Flaps - OPEN
4. Airspeed - ESTABLISH 104 KTS

CRUISE CLIMB

1. Power - SET (25.0 in. Hg or Full Throttle - 2500 RPM)
2. Mixture - LEAN TO APPROPRIATE FUEL FLOW
3. Airspeed - 139 KTS
4. Cowl Flaps - AS REQUIRED

NOTE

In high ambient temperatures, low pressure boost may be required to prevent excessive fuel flow fluctuations.

MAXIMUM NORMAL OPERATING POWER CLIMB (TH-1090 and After)

1. Power - SET:
 - a. With 2-blade propellers installed.....2550 RPM
 - b. With 3-blade propellers installed.....2650 RPM
2. Mixtures - LEAN TO APPROPRIATE FUEL FLOW
3. Cowl Flaps - AS REQUIRED
4. Airspeed - 104 KTS

CRUISE

Maximum Cruise Power 24.5 in. Hg at 2500 rpm
Recommended Cruise Power .. 24.0 in. Hg at 2300 rpm
Recommended Cruise Power .. 21.0 in. Hg at 2300 rpm
Economy Cruise Power 20.5 in. Hg at 2100 rpm

1. Power - SET AS DESIRED (Use Tables in PERFORMANCE section)
2. Fuel Flow - LEAN AS REQUIRED
3. Cowl Flaps - AS REQUIRED

LEANING USING THE EXHAUST GAS TEMPERATURE INDICATOR (EGT)

The system consists of a thermocouple type exhaust gas temperature (EGT) probe mounted in the right side of each exhaust system. This probe is connected to an indicator on the right side of the instrument panel. The indicator is calibrated in degrees Fahrenheit. Use EGT system to lean the fuel/air mixture when cruising at maximum cruise power or less.

INTENTIONALLY LEFT BLANK

1. Lean the mixture and note the point on the indicator that the temperature peaks and starts to fall.
 - a. **CRUISE (LEAN) MIXTURE** - Increase the mixture until the EGT shows a drop of 25°F below peak on the rich side of peak.
 - b. **BEST POWER MIXTURE** - Increase the mixture until the EGT shows a drop of 100°F below peak on the rich side of peak.

CAUTION

Do not continue to lean mixture beyond that necessary to establish peak temperature.

2. Continuous operation is recommended at 25°F or more below peak EGT only on the rich side of peak.
3. Changes in altitude and power settings require the peak EGT to be rechecked and the mixture reset.

DESCENT

1. Altimeter - SET
2. Cowl Flaps - CLOSED
3. Windshield Defroster - AS REQUIRED
4. Power - AS REQUIRED (avoid prolonged idle settings and low cylinder head temperatures)

Recommended descent speeds:

Smooth air	175 kts
Rough air	(Max.) 156 kts

BEFORE LANDING

1. Seat Belts and Shoulder Harnesses - FASTENED, SEAT BACKS UPRIGHT
2. Fuel Selector Valves - CHECK ON
3. Aux. Fuel Pumps - OFF, OR LOW AS PER AMBIENT TEMPERATURE
4. Cowl Flaps - AS REQUIRED
5. Mixture Controls - FULL RICH (or as required by field elevation)
6. Flaps - APPROACH 15° POSITION (Maximum extension speed 152 kts)
7. Landing Gear - DOWN (Gear extension speed 152 kts)
8. Flaps - FULL DOWN (30°) (Maximum extension speed, 122 kts.)
9. Airspeed - ESTABLISH NORMAL LANDING APPROACH SPEED.
10. Propellers - LOW PITCH (high rpm)

BALKED LANDING

1. Propellers - LOW PITCH (high rpm)
2. Power - MAXIMUM ALLOWABLE
3. Airspeed - BALKED LANDING CLIMB SPEED (96 KTS)
4. Flaps - UP (0°)
5. Landing Gear - UP
6. Cowl Flaps - AS REQUIRED

AFTER LANDING

1. Landing and Taxi Lights - AS REQUIRED
2. Flaps - UP
3. Trim Tabs - SET TO ZERO
4. Cowl Flaps - OPEN
5. Aux Fuel Pumps - AS REQUIRED

SHUT DOWN

1. Parking Brake - SET
2. Propellers - HIGH RPM
3. Throttles - 1000 RPM
4. Aux Fuel Pumps - OFF
5. Electrical and Avionics Equipment - OFF
6. Mixture Controls - IDLE CUT-OFF
7. Magneto/Start Switches - OFF, AFTER ENGINES STOP
8. Battery and Alternator Switches - OFF
9. Controls - LOCKED
10. If airplane is to be parked for an extended period of time, install wheel chocks and release the parking brake as greatly varying ambient temperatures may build excessive pressures on the hydraulic system.

NOTE

Induction air scoop covers, included in the loose tools and accessories, are to prevent foreign matter from entering the air scoops while the aircraft is parked.

OXYGEN SYSTEM

WARNING

NO SMOKING permitted when using oxygen.

PREFLIGHT

1. Check Oxygen Pressure Gage for pressure reading.
2. Determine percent of full system.
3. Multiply oxygen duration in minutes by percent of full system.

EXAMPLE:

People	5
Gage Pressure	1500 psi
Percent Capacity (from chart)	80%
Cylinder Capacity (full)	49 cu ft
Altitude (planned flight)	15,000 feet
Duration (full cylinder)	149 minutes
Duration (80% full)	119 minutes

OXYGEN DURATION

Oxygen duration is computed for a Scott Altitude Compensated System assuming 90% of cylinder volume usable and using Scott oxygen masks rated at 3.0 Standard Liters Per Minute (SLPM). These masks are identified by a green color coded plug-in.

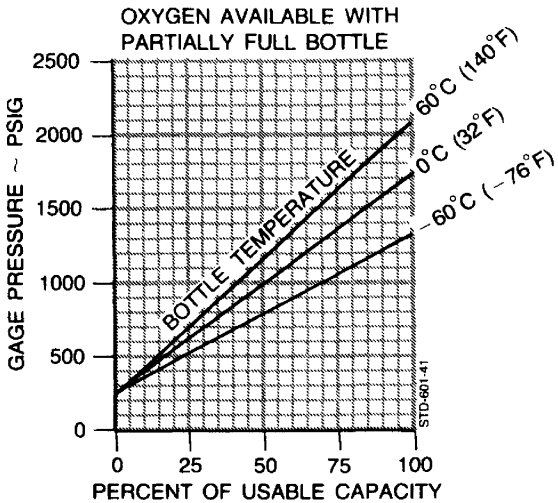

Duration in minutes at the following altitudes:

	Persons Using	12,500	15,000	20,000
49 cu ft	1	1014	746	507
	2	507	373	253
	3	338	248	169
	4	253	186	126
	5	202	149	101
	6	169	124	84
66 cu ft	1	1344	988	672
	2	672	494	336
	3	448	329	224
	4	336	247	168
	5	268	197	134
	6	224	164	112

IN FLIGHT

The use of oxygen is recommended to be in accordance with current FAR operating rules.

1. Oxygen Control Valve - OPEN SLOWLY
2. Mask - INSERT FITTING, DON MASK (adjust mask for proper fit)
3. Oxygen Flow Indicator - CHECK (red plunger lifts from its seat when the hose is inserted into the oxygen coupling)

AFTER USING

1. Discontinue use by unplugging mask from outlet.

NOTE

Closing the control valve while in flight is not necessary due to automatic sealing of the outlet when the mask is unplugged.

2. Oxygen Control Valve - CLOSE (may be accomplished during shut-down).

ELECTRIC ELEVATOR TRIM

1. ON-OFF switch - ON
2. Control Wheel Trim Switch - Forward for nose down, aft for nose up, (when released the switch returns to the center - OFF position)

Malfunction procedures are given in the EMERGENCY PROCEDURES section.

COLD WEATHER OPERATION

PREFLIGHT INSPECTION

In addition to the normal preflight exterior inspection, remove ice, snow and frost from the wings, tail, control surfaces and hinges, propellers, windshield, fuel cell filler caps and fuel vents. If you have no way of removing these formations of ice, snow, and frost leave the airplane on the ground, as these deposits will not blow off. The wing contour may be changed by these formations sufficiently that its lift qualities are considerably disturbed and sometimes completely destroyed. Complete your normal preflight procedures. Check the flight controls for complete freedom of movement.

Conditions for accumulating moisture in the fuel tanks are most favorable at low temperatures due to the condensation increase and the moisture that enters as the system is serviced. Therefore, close attention to draining the fuel system will assume particular importance during cold weather.

ENGINES

Use engine oil in accordance with Consumable Materials in the SERVICING section. Always pull the propeller through by hand several times to clear the engine and "limber up" the cold, heavy oil before using the starter. This will also lessen the load on the battery if an auxiliary power unit is not used.

Under very cold conditions, it may be necessary to preheat the engine prior to a start. Particular attention should be applied to the oil cooler, and engine sump to insure proper preheat. A start with congealed oil in the system may produce an indication of normal pressure immediately after

the start, but then the oil pressure may decrease when residual oil in the engine is pumped back with the congealed oil in the sump. If an engine heater capable of heating both the engine sump, and cooler is not available, the oil should be drained while the engines are hot and stored in a warm area until the next flight.

If there is no oil pressure within the first 30 seconds of running, or if oil pressure drops after a few minutes of ground operation, shut down and check for broken oil lines, oil cooler leaks or the possibility of congealed oil.

NOTE

It is advisable to use external power for starting in cold weather.

During warm-up, watch engine temperatures closely, since it is quite possible to exceed the cylinder head temperature limit in trying to bring up the oil temperature. Exercise the propellers several times to remove cold oil from the pitch change mechanisms. The propellers should also be cycled occasionally in flight.

During letdown and landing, give special attention to engine temperatures, since the engines will have a tendency toward overcooling.

EXTERNAL POWER

It is very important that the following precautions be observed while using external power.

1. The airplane has a negative ground system. Be sure to connect the positive lead of the auxiliary power unit to the positive terminal of the airplane's external power receptacle and the negative lead of the auxiliary power unit to the negative terminal of the external power receptacle. A positive voltage must also be applied to the small guide pin.
2. To prevent arcing, make certain no power is being supplied when the connection is made.
3. Make certain that the battery switch is ON, all avionics and electrical switches OFF, and a battery is in the system before connecting an external power unit. This protects the voltage regulators and associated electrical equipment from voltage transients (power fluctuations).

STARTING ENGINES USING AUXILIARY POWER UNIT

1. Battery switch - ON
2. Alternators, Electrical, and Avionics Equipment - OFF
3. Auxiliary Power Unit - CONNECT
4. Auxiliary Power Unit - SET OUTPUT (27.0 to 28.5 volts)
5. Auxiliary Power Unit - ON
6. Right Engine - START (use normal start procedures)
7. Auxiliary Power Unit - OFF (after engine has been started)
8. Auxiliary Power Unit - DISCONNECT (before starting left engine)
9. Alternator Switches - ON

TAXIING

Avoid taxiing through water, slush or muddy surfaces if possible. In cold weather, water, slush or mud, when splashed onto landing gear mechanisms or control surface hinges may freeze, preventing free movement and resulting in structural damage.

ICE PROTECTION SYSTEMS

The following equipment, when installed and operable, will provide a degree of protection when icing conditions are inadvertently encountered. Since this equipment has not been demonstrated to meet current requirements for flight into known icing conditions, the pilot must exit such conditions as soon as possible if ice accumulates on the airplane.

1. Equipment required for IFR flight
2. Beech approved emergency static air source
3. Beech approved surface deice system
4. Beech approved propeller deice or anti-ice system
5. Beech approved pitot heat
6. Beech approved heated stall warning
7. Beech approved heated fuel vents
8. Beech approved windshield defogging and openable storm window
9. Beech approved alternate induction air
10. Beech approved external antenna masts (capable of withstanding ice loads)

WARNING

Stalling airspeeds should be expected to increase due to the distortion of the wing airfoil when ice has accumulated on the airplane. For the same reason, stall warning devices are not accurate and should not be relied upon. With ice on the airplane, maintain a comfortable margin of airspeed above the normal stall airspeed.

1. EMERGENCY STATIC AIR SOURCE

If the Emergency Static Air Source is desired for use:

- a. Emergency Static Air Source - ON EMERGENCY (lower sidewall adjacent to pilot)
- b. For Airspeed Calibration and Altimeter Corrections, refer to PERFORMANCE section

CAUTION

The emergency static air valve should be in the OFF NORMAL position when the system is not needed.

2. SURFACE DEICE SYSTEM

a. BEFORE TAKE-OFF

- (1) Throttles - 2000 RPM
- (2) Surface Deice Switch - AUTO (UP)
- (3) Deice Pressure - 9 to 20 PSI (while boots are inflating)
- (4) Wing Boots - CHECK VISUALLY FOR INFLATION AND HOLD DOWN

b. IN FLIGHT

When ice accumulates 1 / 2 to 1 inch

- (1) Surface Deice Switch - AUTO (UP)
- (2) Deice Pressure - 9 to 20 PSI (while boots are inflating)
- (3) Repeat - AS REQUIRED

CAUTION

Rapid cycles in succession or cycling before at least 1/2 inch of ice has accumulated may cause the ice to grow outside the contour of the inflated boots and prevent ice removal.

Stall speeds are increased 4 kts in all configurations with surface deice system operating.

NOTE

Either engine will supply sufficient vacuum and pressure for deice operation.

- c.* For Emergency Operation refer to the EMERGENCY PROCEDURES section.

3. ELECTROTHERMAL PROPELLER DEICE

CAUTION

Do not operate the propeller deice when propellers are static.

a. BEFORE TAKEOFF

- (1) Propeller Deice Switch - ON
- (2) Propeller Deice Ammeter - CHECK, 7 to 12 amps (2 Blade), 14 to 18 amps (3 Blade)

b. IN FLIGHT

- (1) Propeller Deice Switch - ON. The system may be operated continuously in flight and will function automatically until the switch is turned OFF.
- (2) Relieve propeller imbalance due to ice by increasing rpm briefly and returning to the desired setting. Repeat as necessary.

CAUTION

If the propeller deice ammeter indicates abnormal reading, refer to the Emergency Procedures section.

INTENTIONALLY LEFT BLANK

4. WINDSHIELD ANTI-ICE SYSTEM
(ELECTROTHERMAL)

a. BEFORE TAKEOFF

- (1) WSHLD Heat Switch – ON (Note deflection on loadmeter)
- (2) Windshield – CHECK (feel for warming)

CAUTION

Ground operation is limited to 10 minutes.

b. IN FLIGHT

NOTE

Continuous operation is permitted.

- (1) WSHLD Heat Switch – AS REQUIRED
(Heat should be applied before ice forms)

NOTE

If directional gyro is to be reset, turn off the electrothermal windshield heat for 15 seconds to allow a stable reading of the standby compass.

**5. PROPELLER AND WINDSHIELD ANTI-ICE SYSTEM
(FLUID FLOW)**

CAUTION

This anti-ice system is designed to PREVENT the formation of ice. Always turn the system ON before entering icing conditions.

a. PREFLIGHT

- (1) Check the quantity in reservoir
- (2) Check slinger ring and lines for obstructions
- (3) Check propeller boots for damage

b. IN FLIGHT

- (1) Prop Anti-ice Switch - ON
- (2) Windshield Anti-ice Switch - CYCLE AS REQUIRED
- (3) Anti-ice Quantity Indicator - MONITOR

NOTE

See SYSTEM description for endurance.

6. PITOT HEAT AND HEATED STALL WARNING

- a. Pitot Heat Switch(es) - ON (Note deflection on Load-meter) Heated Stall Warning is activated by the left pitot heat switch.

NOTE

Switches may be left on throughout flight. Prolonged operation on the ground could damage the Pitot Heat System.

7. FUEL VENT HEAT

- a. Fuel Vent Switch - ON (If ice is encountered)

8. WINDSHIELD DEFOGGING

- a. Defrost Control - PUSH ON
- b. Pilot's Storm Window - OPEN, AS REQUIRED

ENGINE BREAK-IN INFORMATION

Refer to Systems section.

PRACTICE DEMONSTRATION OF V_{MCA}

V_{MCA} demonstration may be required for multi-engine pilot certification. The following procedure shall be used at a safe altitude of at least 5000 feet above the ground in clear air only.

WARNING

Inflight engine cuts below V_{SSE} speed of 86 kts/99 mph are prohibited.

1. Landing Gear - UP
2. Flaps - UP
3. Airspeed - ABOVE 86 KNOTS/ 99 MPH (V_{SSE})
4. Propeller Levers - HIGH RPM

5. Throttle (Simulated inoperative engine) - IDLE
6. Throttle (Other engine) - Maximum Manifold Pressure
7. Airspeed - REDUCE approximately 1 knot per second until either V_{MCA} or stall warning is obtained.

CAUTION

Use rudder to maintain directional control (heading) and ailerons to maintain 5° bank towards the operative engine (lateral attitude). At the first sign of either V_{MCA} or stall warning (which may be evidenced by: inability to maintain heading or lateral attitude, aerodynamic stall buffet, or stall warning horn sound) immediately initiate recovery: reduce power to idle on the operative engine and immediately lower the nose to regain V_{SSE} .

NOISE CHARACTERISTICS

Approach to and departure from an airport should be made so as to avoid prolonged flight at low altitude near noise-sensitive areas. Avoidance of noise-sensitive areas, if practical, is preferable to overflight at relatively low altitudes.

For VFR operations over outdoor assemblies of persons, recreational and park areas, and other noise-sensitive areas, pilots should make every effort to fly not less than 2000 feet above the surface, weather permitting, even though flight at a lower level may be consistent with the provisions of government regulations.

NOTE

The preceding recommended procedures do not apply where they would conflict with Air Traffic Control clearances or instructions, or where, in the pilot's judgement, an altitude of less than 2000 feet is necessary to adequately exercise his duty to see and avoid other airplanes.

Flyover noise levels established in compliance with FAR 36 are:

For Serials TH-1090 and After:

2-Blade Propeller Using MNOP 78.9 dB(A)

3-Blade Propeller Using MNOP 78.8 dB(A)

NOTE

Flyover noise levels given are not applicable for Serials TH-773 thru TH-1089.

No determination has been made by the Federal Aviation Administration that the noise level of this airplane is or should be acceptable or unacceptable for operation at, into, or out of any airport.

SECTION V

PERFORMANCE

TABLE OF CONTENTS

<i>SUBJECT</i>	<i>PAGE</i>
Introduction to Performance and Flight Planning	5-3
Conditions	5-3 - 5-13
Comments Pertinent to the Use of Performance Graphs.....	5-13
Performance Graphs	5-14 - 5-47
Airspeed Calibration - Normal System	5-14
Altimeter Correction - Normal System.....	5-15
Airspeed Calibration - Alternate System	5-16
Altimeter Correction - Alternate System.....	5-17
Fahrenheit to Celsius.....	5-18
ISA Conversion.....	5-19
Manifold Pressure vs RPM.....	5-20
Take-Off Weight.....	5-21
Stall Speeds - Power Idle.....	5-22
Wind Components	5-23
Take-Off Distance.....	5-24
Accelerate - Stop	5-25
Accelerate - Go.....	5-26
Climb - Two Engine (TH-773 thru TH-1089).....	5-26A
Climb - Two Engine (TH-1090 and After)	
2-blade Propellers Installed.....	5-26B
3-blade Propellers Installed.....	5-27
Take-Off Climb Gradient, One Engine Inoperative	5-28

TABLE OF CONTENTS (Continued)

<i>SUBJECT</i>	<i>PAGE</i>
Time, Fuel, Distance to Climb	5-29
Climb - One Engine Inoperative	5-30
Service Ceiling - One Engine Inoperative.....	5-31
Cruise Speeds	5-32
Fuel Flow vs Brake Horsepower	5-33
Cruise Power Settings	5-34 - 5-37
Maximum Cruise Power	5-34
Recommended Cruise Power	5-35
Recommended Cruise Power	5-36
Economy Cruise Power	5-37
Range Profile - 136 Gallons	5-38
Endurance Profile - 136 Gallons	5-39
Range Profile - 166 Gallons	5-40
Endurance Profile - 166 Gallons	5-41
Range Profile - 194 Gallons	5-42
Endurance Profile - 194 Gallons	5-43
Holding Time.....	5-44
Time, Fuel and Distance to Descend	5-45
Climb - Balked Landing	5-46
Landing Distance	5-47

**INTRODUCTION TO PERFORMANCE
AND FLIGHT PLANNING**

All airspeeds quoted in this section are indicated airspeeds (IAS) except as noted and assume zero instrument error.

The graphs and tables in this section present performance information for takeoff, climb, landing and flight planning at various parameters of weight, power, altitude, and temperature. FAA approved performance information is included in this section. Examples are presented on all performance graphs. In addition, the calculations for flight time, block speed, and fuel required are presented using the conditions listed.

Performance with a gross weight of 4990 lbs (Baron 58A) will be equal to or better than that of the higher gross weight Baron 58.

CONDITIONS

At Denver:

Outside Air Temperature 15°C (59°F)
Field Elevation 5330 ft
Altimeter Setting 29.60 in. Hg
Wind 270° at 10 kts
Runway 26L length 10,010 ft

Route of Trip

*DEN-V81-AMA

For VFR Cruise at 11,500 feet

**Section V
Performance**

**BEECHCRAFT Baron 58
Serial TH 773 and After**

ROUTE SEGMENT	MAGNETIC COURSE	DIST NM	WIND 11500 FEET DIR/KTS	OAT 11500 FEET °C	ALT SETTING IN.HG
DEN-COS	161°	55	010/30	-5	29.60
COS-PUB	153°	40	010/30	-5	29.60
PUB-TBE	134°	74	100/20	0	29.56
TBE-DHT	132°	87	200/20	9	29.56
DHT-AMA	125°	65	200/20	10	29.56

*REFERENCE: Enroute Low Altitude Chart L-6

At Amarillo:

Outside Air Temperature 25°C (77°F)
 Field Elevation 3605 ft
 Altimeter Setting 29.56 in. Hg
 Wind 180° at 10 kts
 Runway 21 Length 10,000 ft

To determine pressure altitude at origin and destination airports, add 100 feet to field elevation for each .1 in. Hg below 29.92, and subtract 100 feet from field elevation for each .1 in. Hg above 29.92.

Pressure Altitude at DEN:

$$29.92 - 29.60 = .32 \text{ in. Hg}$$

The pressure altitude at DEN is 320 feet above the field elevation.

$$5330 + 320 = 5650 \text{ ft}$$

Pressure Altitude at AMA:

$$29.92 - 29.56 = .36 \text{ in. Hg}$$

The pressure altitude at AMA is 360 feet above the field elevation.

$$3605 + 360 = 3965 \text{ ft}$$

NOTE

For flight planning, the difference between cruise altitude and cruise pressure altitude has been ignored.

Maximum Allowable Take-off Weight = 5400 lbs

Ramp Weight = 5400 + 24 = 5424 lbs

NOTE

Fuel for start, taxi and take-off is normally 24 pounds.

Enter the Take-Off Weight graph at 5650 feet pressure altitude and 15°C.

The take-off weight to achieve a positive rate-of-climb at lift-off for one engine inoperative is:

Take-off Weight = 4850 pounds

Enter the Take-Off Distance graph at 15°C, 5650 feet pressure altitude, 5400 pounds, and 9.5 knots headwind component.

Ground Roll	1900 ft
Total Distance over 50 ft Obstacle	3090 ft
Lift-off Speed	86 kts
50 Foot Speed	94 kts

Section V
Performance

BEECHCRAFT Baron 58
Serial TH 773 and After

Enter the Accelerate-Stop graph at 15°C, 5650 feet pressure altitude, 5400 pounds, and 9.5 knots headwind component:

Accelerate-Stop Distance 3960 ft
Engine Failure Speed 86 kts

NOTE

Since 3960 feet is less than the available field length (10,010 ft), the accelerate-stop procedure can be performed at any weight.

Take-off at 5400 lbs can be accomplished. However, if an engine failure occurs before becoming airborne, the accelerate-stop procedure must be performed.

The following example assumes the airplane is loaded so that the take-off weight is 4850 pounds.

Although not required by regulations, information has been presented to determine the take-off weight, field requirements and take-off flight path assuming an engine failure occurs during the take-off procedure. The following illustrates the use of these charts.

Enter the Accelerate-Go graph at 15°C, 5650 feet pressure altitude, 4850 pounds, and 9.5 knots headwind component:

Ground Roll 1775 ft
Total Distance Over 50 ft Obstacle 8071 ft
Lift-off Speed 86 kts
50 Foot Speed 94 kts

Enter the graph for Take-off Climb Gradient - One Engine Inoperative at 15°C, 5650 feet pressure altitude, and 4850 pounds.

Climb Gradient 2.1%
Climb Speed 94 kts

A 2.1% climb gradient is 21 feet of vertical height per 1000 feet of horizontal distance.

NOTE

The Climb Gradient - One Engine Inoperative graph assumes zero wind conditions. Climbing into a headwind will result in higher angles of climb, and hence, better obstacle clearance capabilities.

Calculation of horizontal distance to clear an obstacle 90 feet above the runway surface:

Horizontal distance used to climb from 50 feet to 90 feet
 $= (90-50) (1000 \div 21) = 1905$ feet

Total Distance = 8071 + 1905 = 9976 feet

The above results are illustrated below:

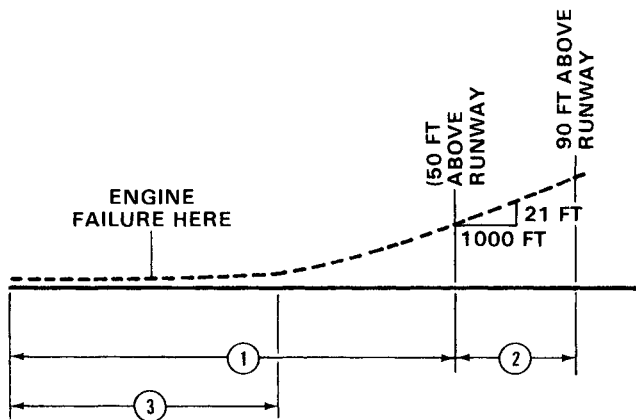

- ① ACCELERATE - GO TAKE-OFF DISTANCE = 8071 FT
- ② DISTANCE TO CLIMB FROM 50 FT TO 90 FT ABOVE RUNWAY = 1905 FT
- ③ ACCELERATE - STOP DISTANCE FOR 5400 LBS TAKE-OFF WEIGHT = 3960 FT

The following calculations provide information for the flight planning procedure. All examples are presented on the performance graphs. A take-off weight of 5400 pounds has been assumed.

Enter the Time, Fuel, and Distance to Climb graph at 15°C to 5650 feet and to 5400 pounds. Also enter at -5°C to 11,500 feet and to 5400 pounds. Read:

Time to Climb = (22 - 7) = 15 min

Fuel Used to Climb = (12.7 - 4.7) = 8 gal

Distance Traveled = (55 - 17) = 38 NM

**BEECHCRAFT Baron 58
Serial TH 773 and After**

**Section V
Performance**

The temperatures for cruise are presented for a standard day (ISA); 20°C (36°F) above a standard day (ISA + 20°C); and 20°C (36°F) below a standard day (ISA - 20°C). These should be used for flight planning. The IOAT values are true temperature values which have been adjusted for the compressibility effects. IOAT should be used for setting cruise power while enroute.

Enter the graph for ISA conversion at 11,500 feet and the temperature for the route segment:

DEN-PUB	OAT	=	-5°C
	ISA Condition	=	ISA + 3°C
PUB-TBE	OAT	=	0°C
	ISA Condition	=	ISA + 8°C
TBE-DHT	OAT	=	9°C
	ISA Condition	=	ISA + 17°C
DHT-AMA	OAT	=	10°C
	ISA Condition	=	ISA + 18°C

Enter the table for recommended cruise power - 24 in. Hg, 2300 rpm at 10,000 ft, 12,000 ft, ISA and ISA + 20°C.

	TEMPERATURE					
	ISA			ISA + 20°C		
ALTI-TUDE FEET	MAN. PRESS. IN. HG	FUEL FLOW GPH/ENG	TAS KNOTS	MAN. PRESS. IN. HG	FUEL FLOW GPH/ENG	TAS KNOTS
10000	20.1	12.3	187	20.1	11.8	187
12000	18.5	11.6	184	18.5	11.2	185

Section V
Performance

BEECHCRAFT Baron 58
Serial TH 773 and After

Interpolate for 11,500 feet and the temperature for the appropriate route segment. Results of the interpolations are:

ROUTE SEGMENT	MAN. PRESS. IN. HG	FUEL FLOW GPH/ENG	TAS KNOTS
DEN-PUB	18.9	11.7	186
PUB-TBE	18.9	11.6	186
TBE-DHT	18.9	11.5	185
DHT-AMA	18.9	11.4	185

NOTE

The preceding are exact values for the assumed conditions.

Enter the graph for Descent at 11,500 feet to the descent line, and enter again at 3965 feet to the descent line, and read:

Time to Descend = (23-8) = 15 min

Fuel Used to Descend = (9.7 -3.3) = 6.4 gal

Descent Distance = (72-25) = 47 NM

Time and fuel used were calculated at Recommended Cruise Power - 24 in. Hg. 2300 RPM as follows:

$$\text{Time} = \frac{\text{Distance}}{\text{Ground Speed}}$$

$$\text{Fuel Used} = (\text{Time}) (\text{Total Fuel Flow})$$

Results are:

ROUTE SEGMENT	DISTANCE NM	EST GROUND SPEED KNOTS	TIME AT CRUISE ALTITUDE HRS: MIN	FUEL USED FOR CRUISE GAL
DEN-COS	*17	215	: 05	1.9
COS-PUB	40	213	: 11	4.4
PUB-TBE	74	171	: 26	10.0
TBE-DHT	87	173	: 30	11.6
DHT-AMA	*18	176	: 06	2.3

*Distance required to climb or descend has been subtracted from segment distance.

TIME - FUEL - DISTANCE

ITEM	TIME HRS: MINS	FUEL GAL	DISTANCE NM
Start, Runup, Taxi and Take-off	0:00	4.0	0
Climb	0:15	8.0	38
Cruise	1:18	30.2	236
Descent	0:15	6.4	47
Total	1:48	48.6	321

Section V
Performance

BEECHCRAFT Baron 58
Serial TH 773 and After

Total Flight Time: 1 hour, 48 minutes

Block Speed: $321 \text{ NM} \div 1 \text{ hour, 48 minutes} = 178 \text{ knots}$

Reserve Fuel: (45 minutes at Economy Cruise Power):

Enter the cruise power settings table for Economy Cruise Power at 11,500 feet for ISA (assume ISA Fuel Flow Rate).

Fuel Flow Per Engine = 10.3 gal/hr

Total Fuel Flow = 20.6 gal/hr (124 lb/hr)

Reserve Fuel = (45 min) (124 lb/hr) = 93 lbs (15.5 gal)

Total Fuel = $48.6 + 15.5 = 64.1$ gallons

The estimated landing weight is determined by subtracting the fuel required for the flight from the ramp weight:

Assumed ramp weight = 5424 lbs

Estimated fuel from DEN to AMA = 64.1 gal (385 lbs)

Estimated landing weight = $5424 - 385 = 5039$ lbs

Examples have been provided on the performance graphs. The above conditions have been used throughout. Rate of climb was determined for the initial cruise altitude conditions.

Enter the graph for Landing Distance - Flaps 30 degrees at 25°C, 3965 feet pressure altitude, 5039 pounds and 9.5 kts headwind component:

Ground Roll	1450 ft
Total Distance over 50 ft Obstacle	2500 ft
Approach Speed	91 kts

Enter the graph for Climb-Balked Landing at 25°C, 3965 feet pressure altitude and 5039 pounds:

Rate-of-Climb	640 ft/min
Climb Gradient	6.5%

COMMENTS PERTINENT TO THE USE OF PERFORMANCE GRAPHS

1. The example, in addition to presenting an answer for a particular set of conditions, also presents the order in which the graphs should normally be used, i.e., if the first item in the example is OAT, then enter the graph at the known OAT.
2. The reference lines indicate where to begin following guide lines. Always project to the reference line first, then follow the guide lines to the next known item.
3. Indicated airspeeds (IAS) were obtained by using the Airspeed Calibration-Normal System.
4. The associated conditions define the specific conditions from which performance parameters have been determined. They are not intended to be used as instructions; however, performance values determined from charts can only be achieved if specific conditions exist.
5. The full amount of usable fuel is available for all approved flight conditions.

Section V
Performance

BEECHCRAFT Baron 58
Serial TH 773 and After

AIRSPEED CALIBRATION - NORMAL SYSTEM

NOTE: INDICATED AIRSPEED ASSUMES ZERO INSTRUMENT ERROR

EXAMPLE

IAS 91 KNOTS
FLAPS DOWN
CAS 89 KNOTS

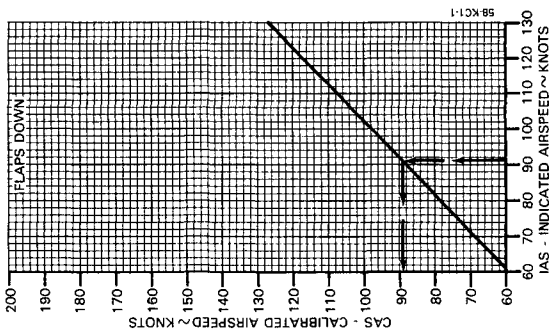
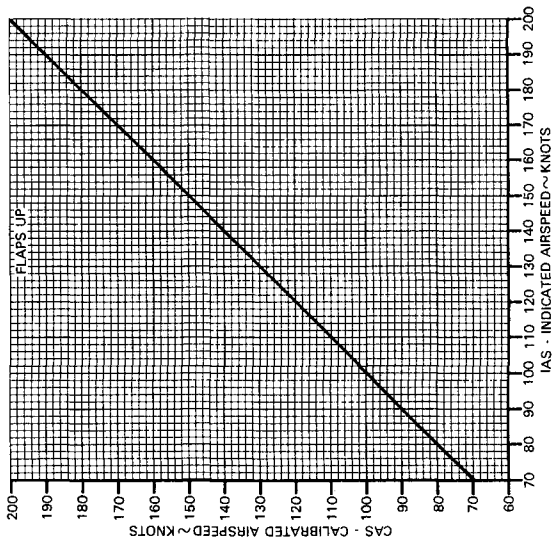

ALTIMETER CORRECTION - NORMAL SYSTEM

NOTE
 INDICATED ALTITUDE AND INDICATED
 AIRSPEED ASSUME ZERO INSTRUMENT ERROR

EXAMPLE:

IAS	91 KTS
FLAPS	DOWN
INDICATED PRESSURE ALTITUDE	3965 FT
ALTIMETER CORRECTION	-21 FT
ACTUAL PRESSURE ALTITUDE	(3965-21) + 3944 FT

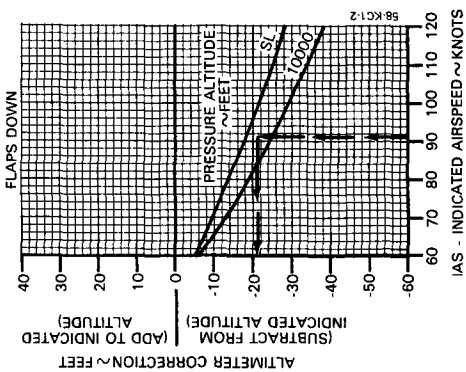
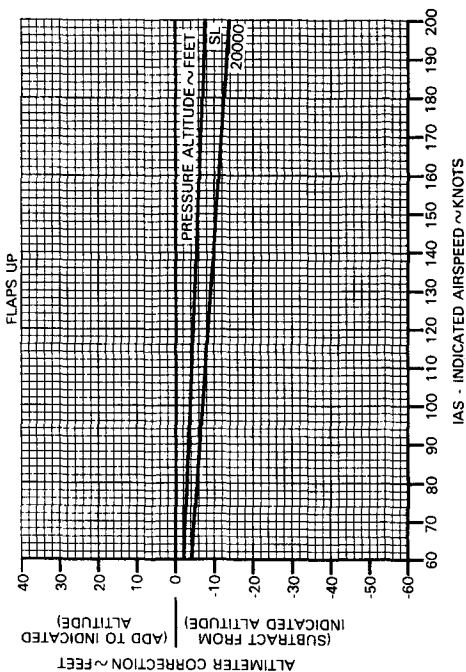

AIRSPEED CALIBRATION - ALTERNATE SYSTEM

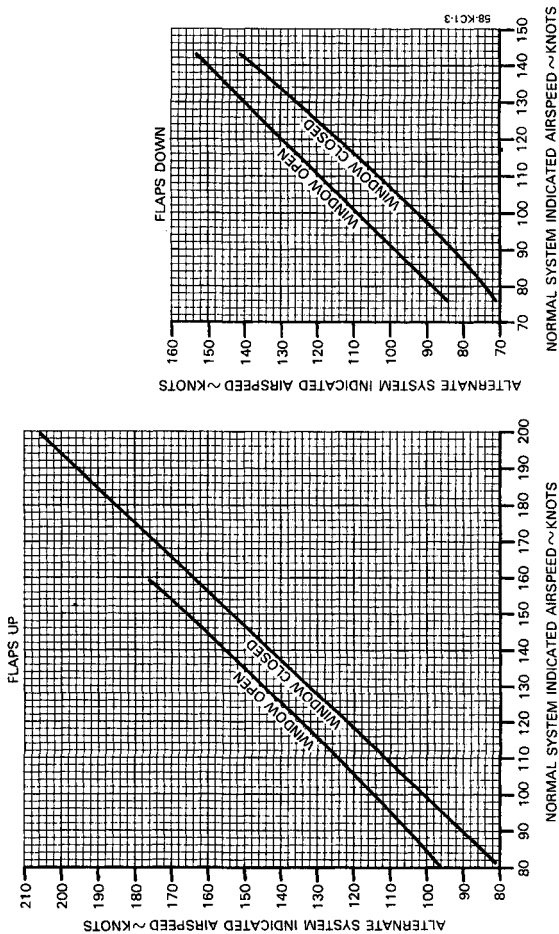

ALTIMETER CORRECTION - ALTERNATE SYSTEM

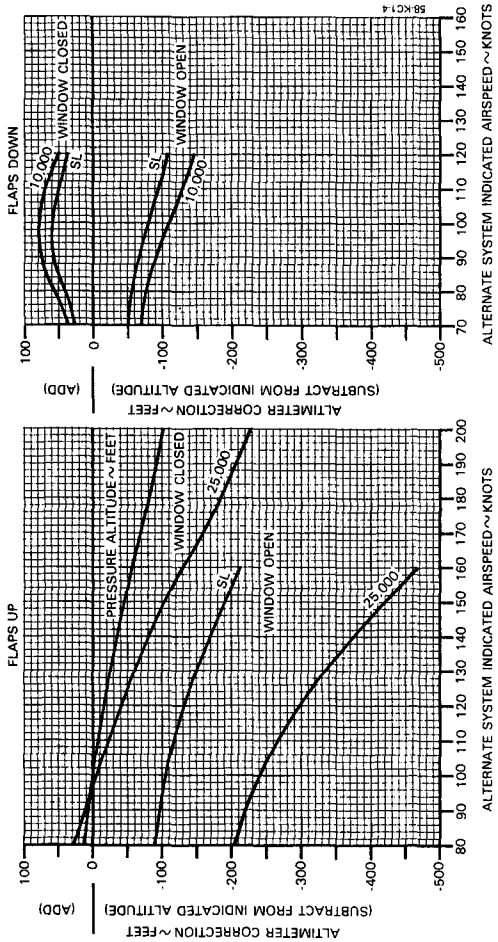

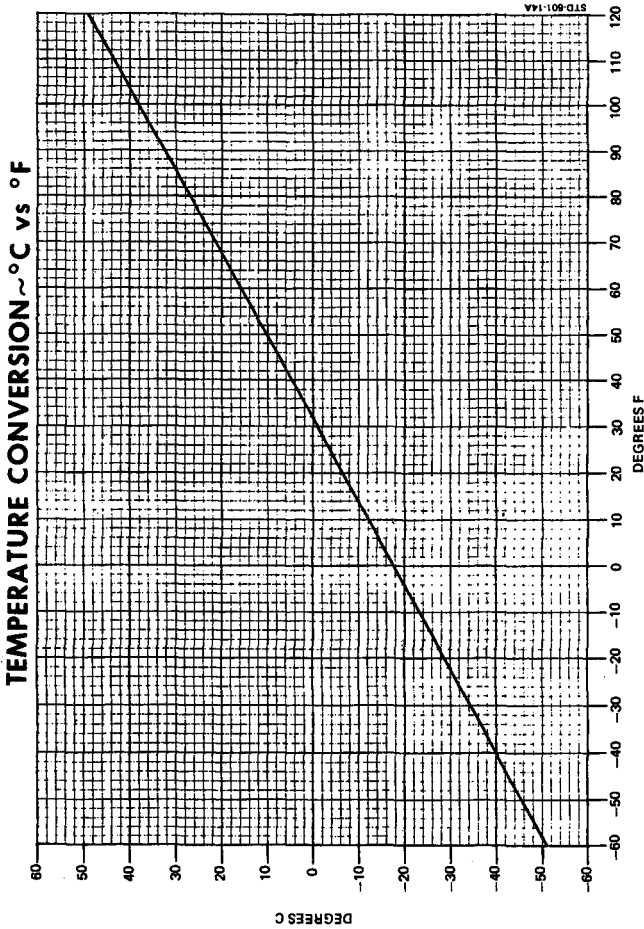

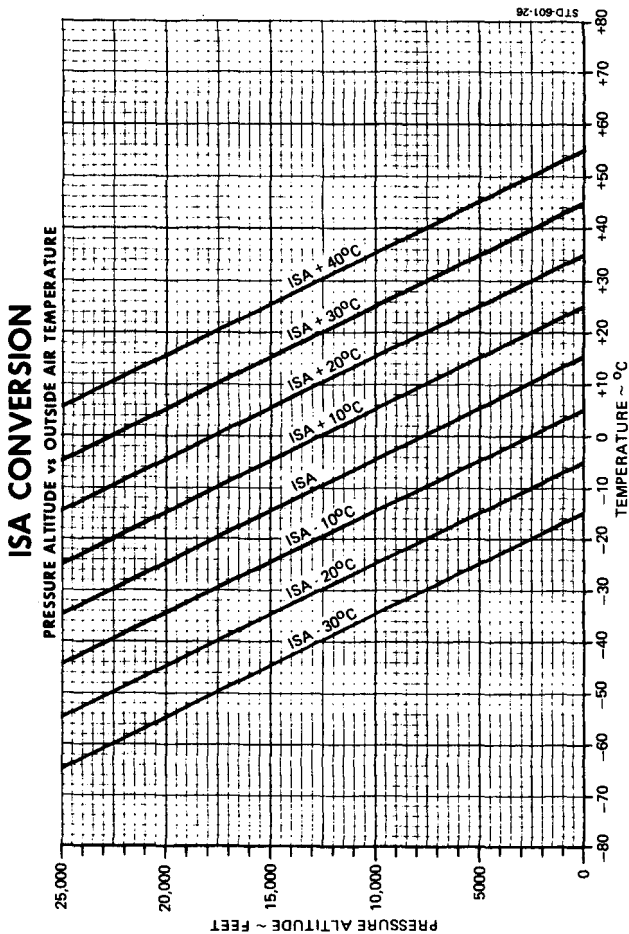

MANIFOLD PRESSURE vs RPM

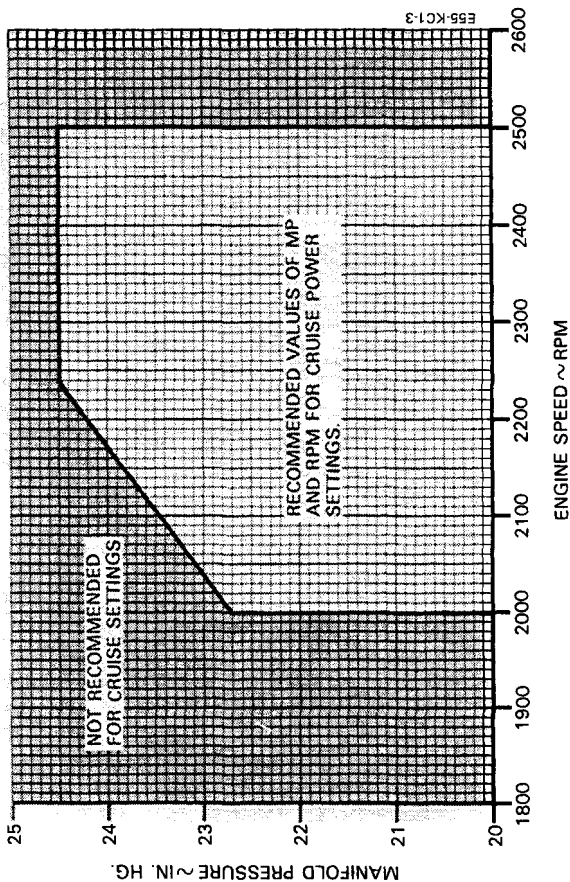

BEECHCRAFT Baron 58 Serial TH 773 and After

Section V Performance

TAKE-OFF WEIGHT

TO ACHIEVE POSITIVE SINGLE ENGINE
RATE-OF-CLIMB AT LIFT-OFF

ASSOCIATED CONDITIONS

AIRPLANE	AIRBORNE
POWER	TAKE-OFF
FLAPS	UP
LANDING GEAR	DOWN
INOPERATIVE PROPELLER	FEATHERED

EXAMPLE:

PRESSURE ALTITUDE	5650 FEET
OAT	15°C
TAKE-OFF WEIGHT	4850

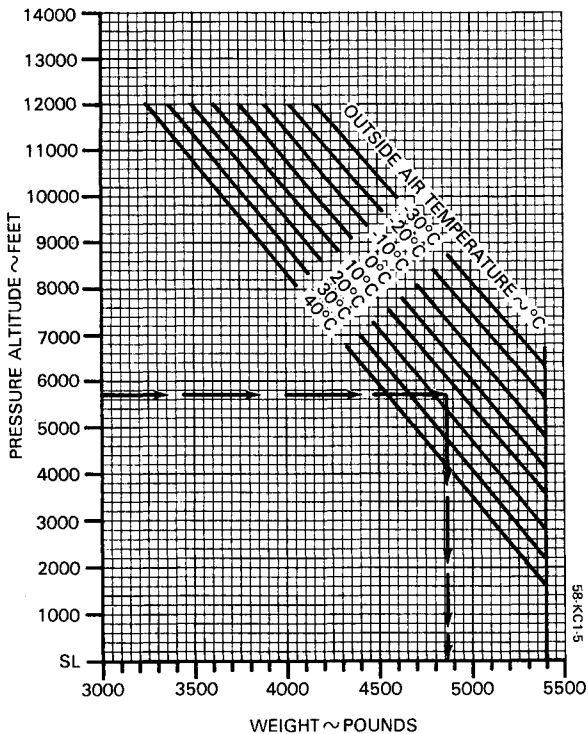

Section V Performance

BEECHCRAFT Baron 58 Serial TH 773 and After

EXAMPLE:

WEIGHT 4850 LBS
FLAPS UP
ANGLE OF BANK 20°
STALL SPEED 82 KIAS
80 KCAS

STALL SPEEDS - POWER IDLE

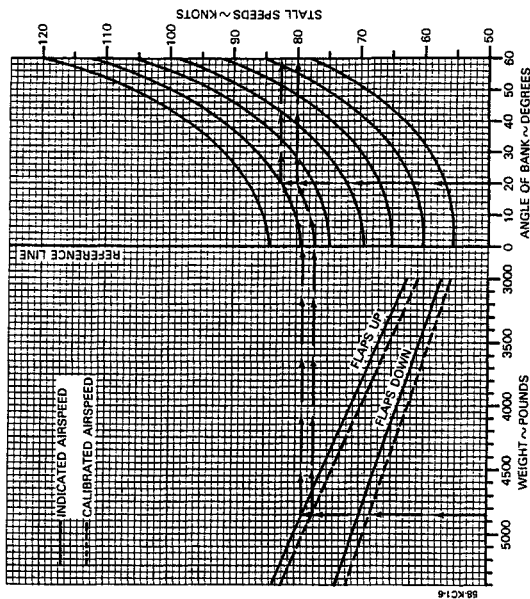

NOTES:

1. THE MAXIMUM ALTITUDE LOSS EXPERIENCED WHILE CONDUCTING STALLS IN ACCORDANCE WITH CAM 3 120 WAS 350 FT.
2. A NORMAL STALL RECOVERY TECHNIQUE MAY BE USED

WIND COMPONENTS

Demonstrated Crosswind Component is 22 kts

EXAMPLE:

WIND SPEED	20 KTS
ANGLE BETWEEN WIND DIRECTION AND FLIGHT PATH	50°
HEADWIND COMPONENT	13 KTS
CROSSWIND COMPONENT	15 KTS

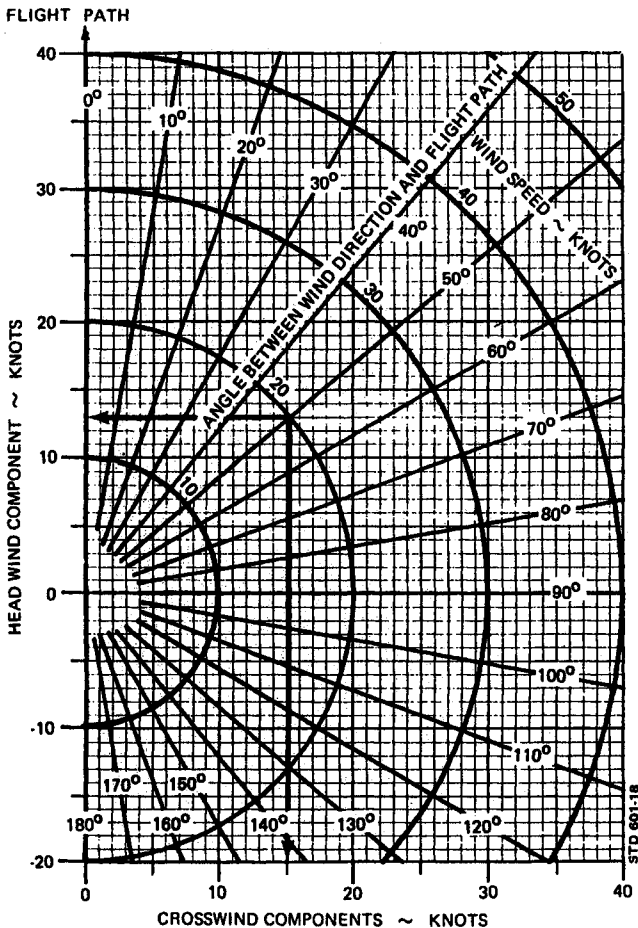

Section V Performance

BEECHCRAFT Baron 58 Serial TH 773 and After

TAKE-OFF DISTANCE

ASSOCIATED CONDITION:

- POWER TAKE-OFF POWER
- MIXTURE LEAN TO APPROPRIATE
- FUELS FUEL FLOW
- FLAPS UP
- LANDING GEAR RETRACT AFTER POSITIVE CLIMB ESTABLISHED
- COWL FLAPS OPEN

EXAMPLE:

- OAT 15°C (59°F)
 - PRESSURE ALTITUDE 5850 FEET
 - TAKE-OFF WEIGHT 5400 LBS
 - HEAD WIND COMPONENT 9.5 KNOTS
-
- GROUND ROLL 1900 FEET
 - TOTAL DISTANCE OVER 50 FT OBSTACLE 3090 FEET
 - TAKE-OFF SPEED AT 86 KTS
 - LIFT-OFF 94 KTS
 - LIFT-OFF 50 FT

- TAKE-OFF SPEEDS (ALL WEIGHTS)
- LIFT-OFF 86 KNOTS
- 50 FEET 94 KNOTS

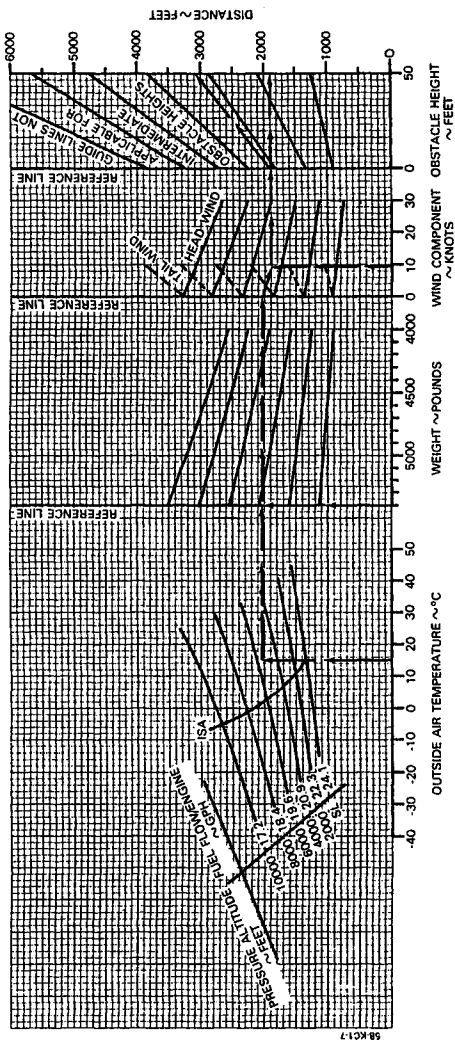

ACCELERATE - STOP DISTANCE

ASSOCIATED CONDITIONS:
 POWER 1. TAKE-OFF POWER
 FLAPS UP
 COWL FLAPS OPEN

DECISION SPEED (ALL WEIGHTS)
 86 KNOTS

EXAMPLE:
 OAT 15°C
 PRESSURE ALTITUDE 5650 FT
 TAKE-OFF WEIGHT 5400 LBS
 HEAD WIND 9.5 KTS

ACCELERATE - STOP DISTANCE
 3960 FT
DECISION SPEED (IAS)
 86 KTS

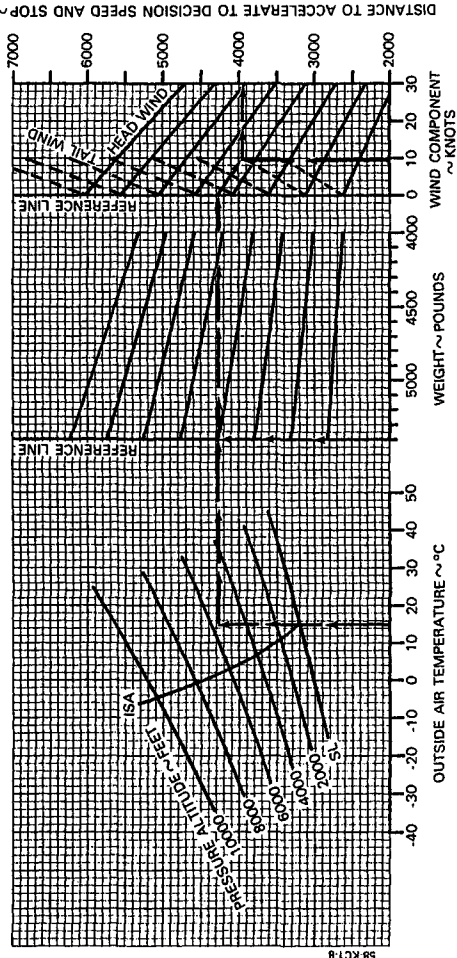

58 KC 18

Section V Performance

BEECHCRAFT Baron 58 Serial TH 773 and After

ACCELERATE - GO DISTANCE

ASSOCIATED CONDITIONS:

POWER TAKE-OFF POWER
 UP
 FLAPS RETRACT AFTER LIFT-OFF
 LANDING GEAR PAVED, LEVEL, DRY SURFACE
 RUNWAY

TAKE-OFF SPEEDS (ALL WEIGHTS)
 LIFT-OFF 86 KNOTS
 50 FEET 94 KNOTS

EXAMPLE:

OAT 15°C
 PRESSURE ALTITUDE 5650 FT
 TAKE-OFF WEIGHT 4850 LBS
 HEAD WIND COMPONENT 9.5 KTS
 GROUND ROLL 1775 FT
 TOTAL DISTANCE OVER 8071 FT
 50 FT OBSTACLE

- NOTES:
1. DISTANCES ASSUME AN ENGINE FAILURE AT LIFT-OFF AND PROPELLER IMMEDIATELY FEATHERED. WEIGHTS IN SHADED AREAS MAY NOT PROVIDE ONE ENGINE INOPERATIVE CLIMB. REFER TO TAKE-OFF WEIGHT GRAPH FOR MAXIMUM WEIGHT AT WHICH THE ACCELERATE-GO PROCEDURE SHOULD BE ATTEMPTED

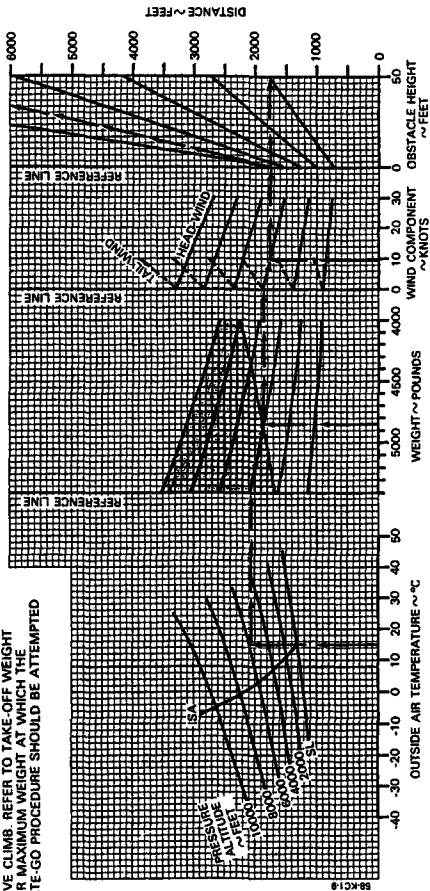

BEECHCRAFT Baron 58
Serial TH 773 and After

Section V
Performance

CLIMB - TWO ENGINE

(TH-773 thru TH-1089)

CLIMB SPEED 104 KNOTS (ALL WEIGHTS)

ASSOCIATED CONDITIONS

- POWER MAXIMUM CONTINUOUS
- FLAPS UP
- LANDING GEAR UP
- COWL FLAPS OPEN
- MIXTURE LEAN TO APPROPRIATE
- FUEL FLOW FUEL FLOW

EXAMPLE

- OAT 15°C
- PRESSURE ALTITUDE 11500 FEET
- WEIGHT 5352 LBS
- RATE OF CLIMB 550 FPM
- CLIMB GRADIENT 4%

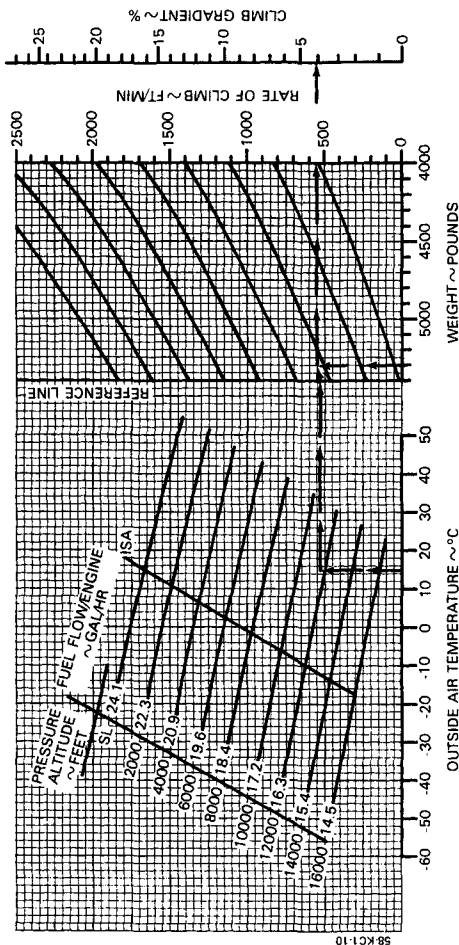

CLIMB-TWO ENGINE (2-BLADE PROPELLER)

(TH-1090 and After)
CLIMB SPEED 104 KNOTS (ALL WEIGHTS)

ASSOCIATED CONDITIONS:

- POWER FULL THROTTLE AT 2550 RPM
- FLAPS UP
- LANDING GEAR UP
- COWL FLAPS OPEN
- MIXTURE LEAN TO APPROPRIATE
- FUEL FLOW

EXAMPLE:

- OAT 15°C
- PRESSURE ALTITUDE 11,500 FT
- WEIGHT 5352 LBS
- RATE OF CLIMB 500 FT/MIN
- CLIMB GRADIENT 4%

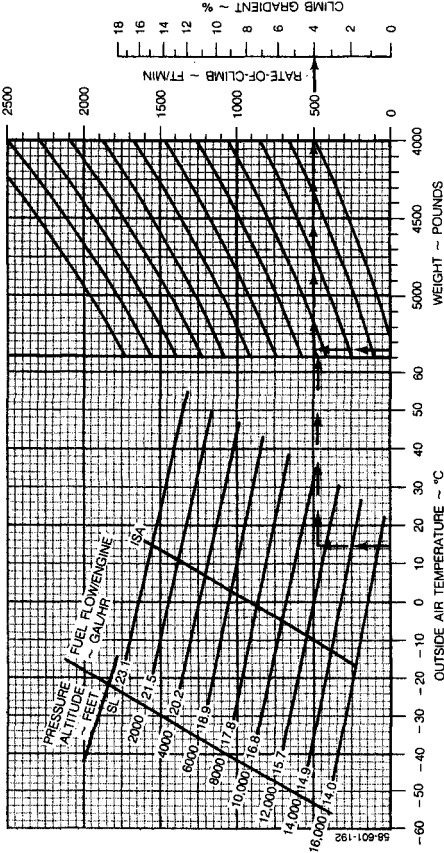

CLIMB-TWO ENGINE (3-BLADE PROPELLER)

(TH-1090 and After)

CLIMB SPEED 104 KNOTS (ALL WEIGHTS)

ASSOCIATED CONDITIONS:

POWER FULL THROTTLE AT 2650 RPM
 FLAPS UP
 LANDING GEAR UP
 COWL FLAPS OPEN
 MIXTURE LEAN TO APPROPRIATE FUEL FLOW

EXAMPLE:

OAT 15°C
 PRESSURE ALTITUDE 11,500 FT
 WEIGHT 5352 LBS
 RATE OF CLIMB 535 FT/MIN
 CLIMB GRADIENT 4.2%

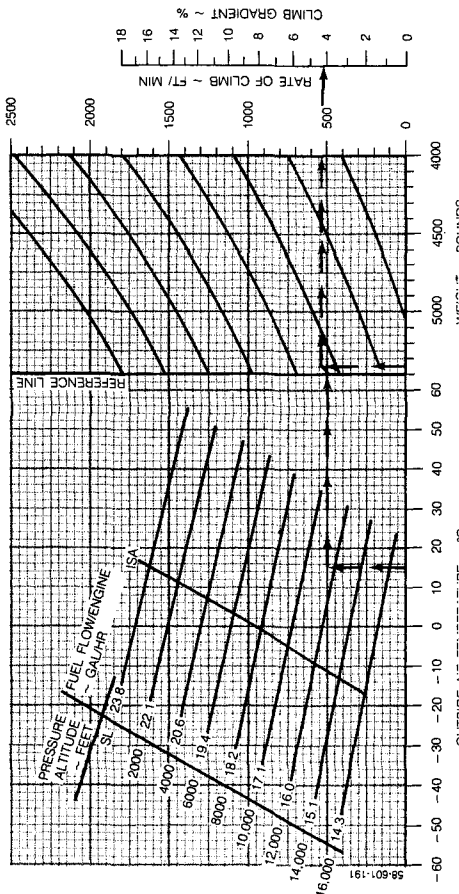

Section V Performance

BEECHCRAFT Baron 58 Serial TH 773 and After

TAKE-OFF CLIMB GRADIENT - ONE ENGINE INOPERATIVE

ASSOCIATED CONDITIONS:

- POWER TAKE-OFF
- LANDING GEAR UP
- FLAPS UP
- INOPERATIVE FEATHERED
- PROPELLER

CLIMB SPEED (ALL WEIGHTS)
94 KTS

EXAMPLE:

- OAT 15°C
- PRESSURE ALTITUDE 5650 FT
- WEIGHT 4850 LBS
- GRADIENT OF CLIMB 2.1%
- CLIMB SPEED 94 KTS

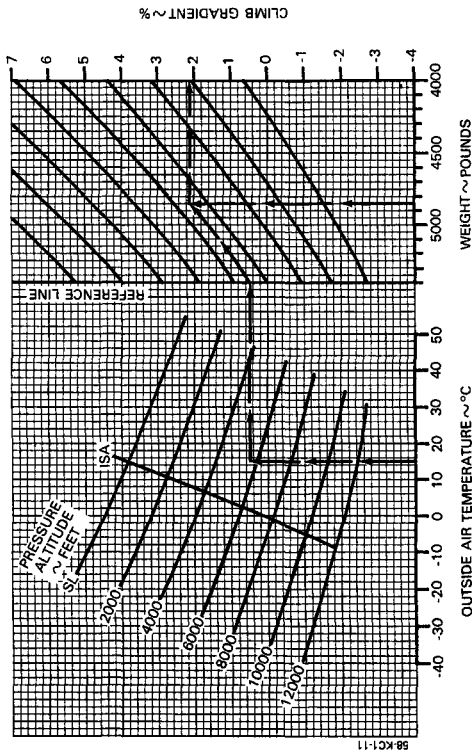

BEECHCRAFT Baron 58 Serial TH 773 and After

Section V Performance

TIME, FUEL AND DISTANCE TO CLIMB

ASSOCIATED CONDITIONS:
 POWER 25 IN. HG. OR
 FULL THROTTLE, 2500 RPM
 FUEL DENSITY 6.0 LB/GAL
 MIXTURE LEAN TO APPROPRIATE FUEL FLOW
 COWL FLAPS CLOSED

CLIMB SPEED 139 KNOTS

EXAMPLE:
 OAT AT TAKE-OFF 15°C
 OAT AT CRUISE 5°C
 AIRPORT PRESSURE 5650 FT
 ALTITUDE 11500 FT
 CRUISE PRESSURE 11500 FT
 ALTITUDE 5400 LBS
 INITIAL CLIMB WEIGHT

(22.7) = 15 MIN
 (12.7; 4.7) = 8 GAL
 (65-17) = 38 NM

TIME TO CLIMB
 FUEL TO CLIMB
 DISTANCE TO CLIMB

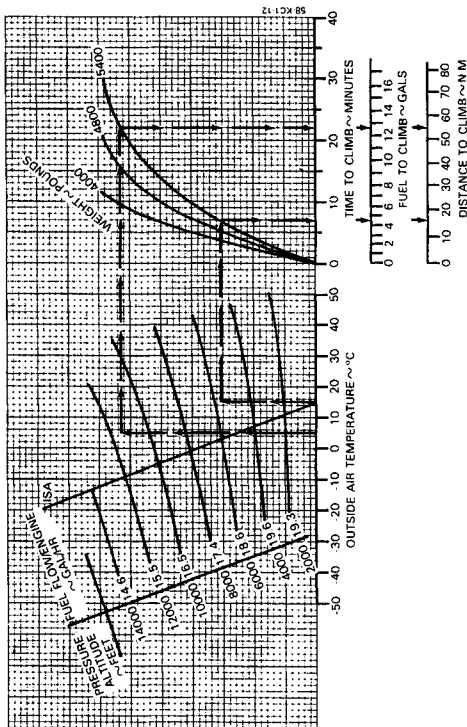

Section V Performance

BEECHCRAFT Baron 58 Serial TH 773 and After

CLIMB - ONE ENGINE INOPERATIVE

ASSOCIATED CONDITIONS:

POWER UP
 FLAPS INOPERATIVE
 LANDING GEAR INOPERATIVE
 PROPELLER OPEN
 MIXTURE LEAN TO APPROPRIATE
 FUEL FLOW FEATHERED

CLIMB SPEED 100 KNOTS (ALL WEIGHTS)

OAT 15°C
 PRESSURE ALTITUDE 5650 FT
 WEIGHT 4850 LBS
 RATE-OF-CLIMB 200 FPM
 CLIMB GRADIENT 2%

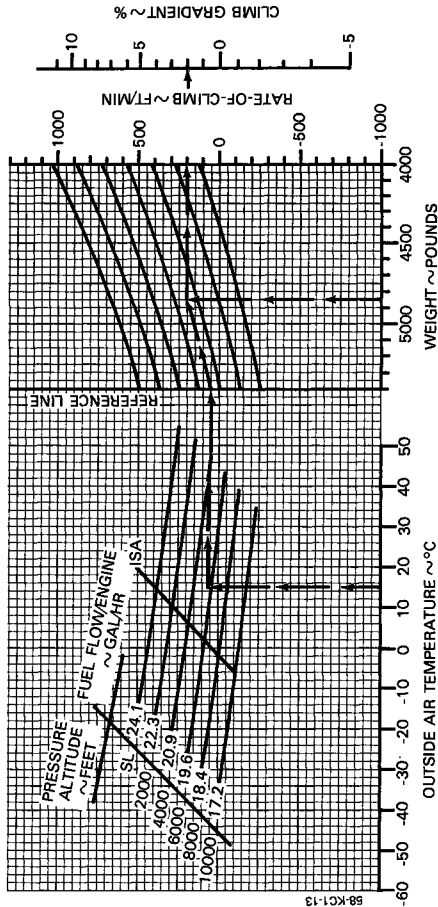

SERVICE CEILING - ONE ENGINE INOPERATIVE

ASSOCIATED CONDITIONS:

POWER	MAXIMUM CONTINUOUS
LANDING GEAR	UP
INOPERATIVE PROPELLER	FEATHERED
FLAPS	UP

EXAMPLE:

OAT	15°C
WEIGHT	4850
<hr/>	
SERVICE CEILING	8425 FT

NOTE:
SERVICE CEILING IS THE PRESSURE ALTITUDE WHERE AIRPLANE
HAS CAPABILITY OF CLIMBING 50 FT MINUTE WITH ONE
PROPELLER FEATHERED

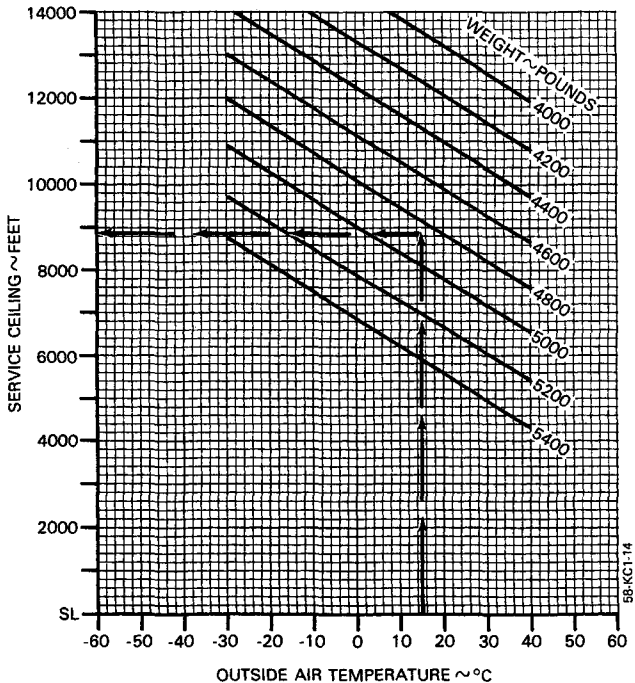

Section V Performance

BEECHCRAFT Baron 58 Serial TH 773 and After

CRUISE SPEEDS

ASSOCIATED CONDITIONS:

AVERAGE CRUISE WEIGHT 5000 LBS
TEMPERATURE STANDARD DAY (ISA)

EXAMPLE:

PRESSURE ALTITUDE 11500 FEET
POWER SETTING FULL THROTTLE 2300 RPM

TRUE AIRSPEED 185 KNOTS

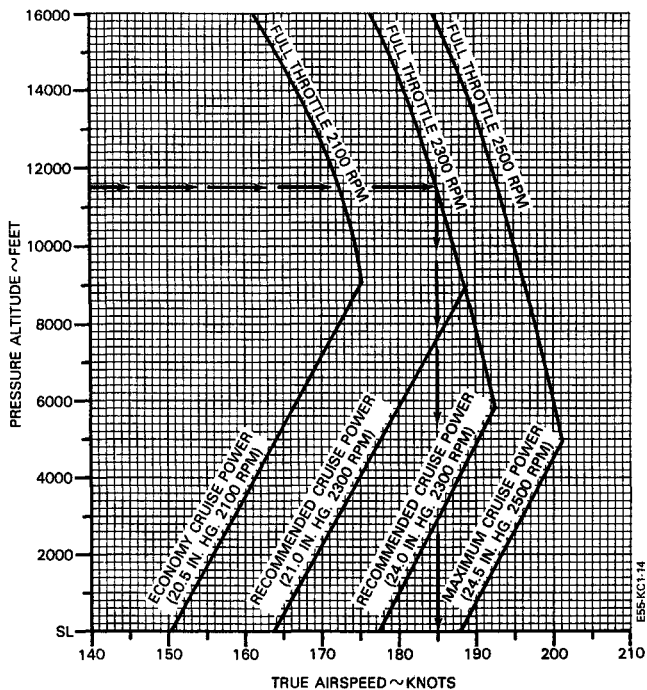

FUEL FLOW vs BRAKE HORSEPOWER

EXAMPLE

FUEL FLOW/ENGINE 11.7 GAL/HR
CONDITIONS LEVEL FLIGHT
CRUISE LEAN

BRAKE HORSEPOWER 160 HP
PER ENGINE

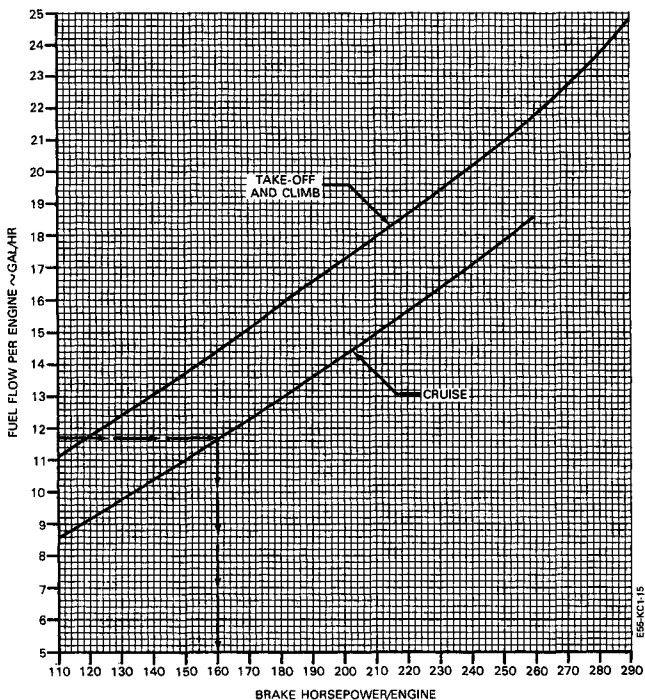

CRUISE POWER SETTINGS

CRUISE POWER SETTINGS
MAXIMUM CRUISE POWER
24.5 IN. HG. @ 2500 RPM (OR FULL THROTTLE)
5200 LBS.

PRESS ALT.	ISA -36°F (-20°C)						STANDARD DAY (ISA)						ISA +36°F (+20°C)											
	OAT		ENGINE SPEED	MAN. PRESS	FUEL FLOW/ ENGINE	TAS	CAS	OAT	ENGINE SPEED	MAN. PRESS	FUEL FLOW/ ENGINE	TAS	CAS	OAT	ENGINE SPEED	MAN. PRESS	FUEL FLOW/ ENGINE	TAS	CAS					
	°F	°C																		°F	°C	°F	°C	RPM
SL	28	-2	2500	24.5	96	16.0	186	193	64	18	2500	24.5	93	15.4	188	188	100	38	2500	24.5	90	14.8	189	183
2000	21	-6	2500	24.5	98	15.9	192	193	57	14	2500	24.5	95	15.8	193	188	95	35	2500	24.5	91	15.2	195	183
4000	16	-9	2500	24.5	100	16.7	197	192	52	11	2500	24.5	96	16.1	199	187	88	31	2500	24.5	93	15.5	200	182
6000	9	-13	2500	23.4	97	16.2	198	188	45	7	2600	23.4	93	15.6	200	183	81	27	2500	23.4	90	15.0	201	178
8000	1	-17	2600	22.0	90	15.0	196	181	37	3	2500	22.0	87	14.5	197	176	73	23	2600	22.0	84	14.0	199	170
10000	-6	-21	2600	20.0	84	14.0	194	174	30	-1	2500	20.0	82	13.6	195	168	66	19	2500	20.0	79	13.1	196	163
12000	-13	-25	2500	18.3	78	13.1	191	166	23	-5	2500	18.3	76	12.7	192	161	68	15	2500	18.3	73	12.2	193	155
14000	-20	-29	2500	16.8	73	12.2	188	158	16	-9	2500	16.8	71	11.9	189	153	52	11	2500	16.3	69	11.4	189	148
16000	-29	-34	2500	15.5	68	11.3	184	150	7	-14	2500	15.5	66	11.0	195	145	43	6	2500	15.5	64	10.6	185	139

NOTES:

1. FULL THROTTLE MANIFOLD PRESSURE SETTINGS ARE APPROXIMATE
2. SHADED AREA REPRESENTS OPERATION WITH FULL THROTTLE

CRUISE POWER SETTINGS

CRUISE POWER SETTINGS
 RECOMMENDED CRUISE POWER
 24.0 IN. HG. @ 2300 RPM (OR FULL THROTTLE)
 5200 LBS.

PRESS ALT.	ISA -36°F (-20°C)										STANDARD DAY (ISA)										ISA +36°F (+20°C)									
	OAT		ENGINE SPEED		MAN. PRESS		FUEL FLOW/ENGINE		TAS CAS		OAT		ENGINE SPEED		MAN. PRESS		FUEL FLOW/ENGINE		TAS CAS		OAT		ENGINE SPEED		MAN. PRESS		FUEL FLOW/ENGINE		TAS CAS	
	°F	°C	RPM	RPM	IN HG	PPH	GPH	KTS	KTS	KTS	°F	°C	RPM	RPM	IN HG	PPH	GPH	KTS	KTS	KTS	°F	°C	RPM	RPM	IN HG	PPH	GPH	KTS	KTS	
SL	27	-3	2300	2300	24.0	83	13.9	176	183	64	18	2300	2300	24.0	81	13.5	178	178	100	38	2300	2300	24.0	78	13.0	179	173	173		
2000	21	-6	2300	2300	24.0	85	14.2	181	182	57	14	2300	2300	24.0	82	13.7	183	177	93	34	2300	2300	24.0	80	13.3	184	172	172		
4000	14	-10	2300	2300	24.0	87	14.5	187	183	50	10	2300	2300	24.0	84	14.1	188	177	86	30	2300	2300	24.0	81	13.6	189	172	172		
6000	7	-14	2300	2300	23.5	88	14.6	190	181	45	7	2300	2300	23.5	85	14.1	192	176	81	27	2300	2300	23.5	82	13.6	193	171	171		
8000	0	-18	2300	2300	21.8	82	13.6	188	174	36	2	2300	2300	21.8	79	13.2	190	169	73	23	2300	2300	21.8	76	12.7	191	164	164		
10000	-8	-22	2300	2300	20.1	76	12.7	186	166	28	-2	2300	2300	20.1	74	12.3	187	181	64	18	2300	2300	20.1	71	11.9	187	156	156		
12000	-15	-26	2300	2300	18.5	72	11.9	163	159	21	-6	2300	2300	18.5	69	11.6	184	154	57	14	2300	2300	18.5	67	11.2	185	149	149		
14000	-22	-30	2300	2300	17.1	62	10.3	171	144	14	-10	2300	2300	17.1	59	9.9	171	139	50	10	2300	2300	17.1	57	9.5	170	133	133		
16000	-29	-34	2300	2300	15.6	59	9.8	169	138	7	-14	2300	2300	15.6	56	9.4	169	132	43	6	2300	2300	15.6	54	9.1	167	128	128		

NOTES:

1. FULL THROTTLE MANIFOLD PRESSURE SETTINGS ARE APPROXIMATE
2. SHADED AREA REPRESENTS OPERATION WITH FULL THROTTLE

CRUISE POWER SETTINGS

CRUISE POWER SETTINGS
RECOMMENDED CRUISE POWER
21.0 IN. HG. @ 2300 RPM (OR FULL THROTTLE)
5200 LBS.

PRESS ALT.	ISA -36°F (-20°C)						STANDARD DAY (ISA)						ISA +36°F (+20°C)									
	OAT		ENGINE SPEED	MAN. PRESS	FUEL FLOW/ ENGINE	TAS	CAS	KTS	OAT	ENGINE SPEED	MAN. PRESS	FUEL FLOW/ ENGINE	TAS	CAS	KTS	OAT	ENGINE SPEED	MAN. PRESS	FUEL FLOW/ ENGINE	TAS	CAS	KTS
	°F	°C	RPM	IN HG	PPH/GPH	KTS	KTS	°F	°C	RPM	IN HG	PPH/GPH	KTS	KTS	°F	°C	RPM	IN HG	PPH/GPH	KTS	KTS	
SL	27	-3	2300	21.0	70	11.6	163	168	63	17	2300	21.0	68	11.3	164	164	2300	21.0	66	10.9	164	159
2000	21	-6	2300	21.0	72	12.0	168	169	57	14	2300	21.0	70	11.6	169	164	2300	21.0	67	11.2	169	159
4000	14	-10	2300	21.0	74	12.4	173	170	50	10	2300	21.0	72	12.0	175	165	2300	21.0	70	11.6	175	160
6000	7	-14	2300	21.0	76	12.7	179	170	93	6	2300	21.0	74	12.3	180	165	2300	21.0	72	11.9	181	160
8000	0	-18	2300	21.0	78	13.1	185	170	36	2	2300	21.0	76	12.7	186	165	2300	21.0	73	12.2	187	160
10000	-3	-22	2300	20.2	76	12.7	185	166	28	-2	2300	20.2	74	12.3	187	161	2300	20.2	71	11.9	187	156
12000	-10	-26	2300	19.5	72	12.0	183	160	21	-6	2300	18.6	69	11.6	184	154	2300	18.6	67	11.2	185	149
14000	-17	-30	2300	17.0	62	10.3	171	144	14	-10	2300	17.0	59	9.9	171	139	2300	17.0	57	9.5	170	133
16000	-23	-34	2300	15.7	56	9.8	163	138	7	-14	2300	15.7	55	9.4	165	132	2300	15.7	54	9.1	167	128

NOTES:

1. FULL THROTTLE MANIFOLD PRESSURE SETTINGS ARE APPROXIMATE
2. SHADED AREA REPRESENTS OPERATION WITH FULL THROTTLE

CRUISE POWER SETTINGS

CRUISE POWER SETTINGS
 ECONOMY CRUISE POWER
 20.5 IN. HG. @ 2100 RPM (OR FULL THROTTLE)
 5200 LBS.

PRESS ALT.	ISA -36°F (-20°C)										STANDARD DAY (ISA)										ISA +36°F (+20°C)															
	OAT		ENGINE SPEED		MAN. PRESS		FUEL FLOW/ENGINE		TAS		CAS		OAT		ENGINE SPEED		MAN. PRESS		FUEL FLOW/ENGINE		TAS		CAS		OAT		ENGINE SPEED		MAN. PRESS		FUEL FLOW/ENGINE		TAS		CAS	
	°F	°C	RPM	RPM	IN HG	PPH	GPH	KTS	KTS	KTS	°F	°C	RPM	RPM	IN HG	PPH	GPH	KTS	KTS	°F	°C	RPM	RPM	IN HG	PPH	GPH	KTS	KTS	°F	°C	RPM	RPM	IN HG	PPH	GPH	KTS
SL	27	-3	2100	2100	20.5	60	10.0	151	156	63	17	2100	2100	20.5	58	9.6	151	151	99	37	2100	2100	20.5	56	9.2	151	146	9.2	151	146	9.2	151	146	9.2	151	146
2000	19	-7	2100	2100	20.5	62	10.3	156	157	55	13	2100	2100	20.5	59	9.9	156	152	91	33	2100	2100	20.5	57	9.5	156	146	9.5	156	146	9.5	156	146	9.5	156	146
4000	12	-11	2100	2100	20.5	63	10.6	160	157	48	9	2100	2100	20.5	61	10.2	161	152	84	29	2100	2100	20.5	59	9.8	161	147	9.8	161	147	9.8	161	147	9.8	161	147
6000	7	-14	2100	2100	20.5	66	10.9	166	158	43	6	2100	2100	20.5	64	10.6	167	153	79	26	2100	2100	20.5	62	10.3	167	148	10.3	167	148	10.3	167	148	10.3	167	148
8000	0	-18	2100	2100	20.5	66	11.1	170	157	36	2	2100	2100	20.5	64	10.7	171	152	72	22	2100	2100	20.5	62	10.4	171	147	10.4	171	147	10.4	171	147	10.4	171	147
10000	-8	-22	2100	2100	20.2	66	11.1	174	155	28	-2	2100	2100	20.2	64	10.7	174	150	64	18	2100	2100	20.2	62	10.4	174	144	10.4	174	144	10.4	174	144	10.4	174	144
12000	-15	-26	2100	2100	18.6	63	10.5	171	149	21	-6	2100	2100	18.6	61	10.1	171	143	57	14	2100	2100	18.6	59	9.3	170	137	9.3	170	137	9.3	170	137	9.3	170	137
14000	-22	-30	2100	2100	17.0	58	9.7	167	140	14	-10	2100	2100	17.0	56	9.4	167	135	50	10	2100	2100	17.0	54	9.0	165	128	9.0	165	128	9.0	165	128	9.0	165	128
16000	-29	-34	2100	2100	15.7	54	9.0	162	132	7	-14	2100	2100	15.7	52	8.7	160	125	43	6	2100	2100	15.7	50	8.4	157	118	8.4	157	118	8.4	157	118	8.4	157	118

NOTES:

1. FULL THROTTLE MANIFOLD PRESSURE SETTINGS ARE APPROXIMATE
2. SHADED AREA REPRESENTS OPERATION WITH FULL THROTTLE

Section V Performance

BEECHCRAFT Baron 58 Serial TH 773 and After

RANGE PROFILE - 136 GALLONS

ASSOCIATED CONDITIONS:

5000 LBS
AVIATION GASOLINE
FUEL DENSITY 6.0 LBS/GAL
INITIAL FUEL LOADING 136 U.S. GALS (816 LBS)

STANDARD DAY (ISA)

EXAMPLE:

PRESSURE ALTITUDE 11500 FEET
FULL THROTTLE
POWER SETTING 2300 RPM

RANGE 870 NM

NOTE:

RANGE INCLUDES START, TAXI, CLIMB, AND DESCENT
WITH 45 MINUTES RESERVE FUEL AT ECONOMY CRUISE

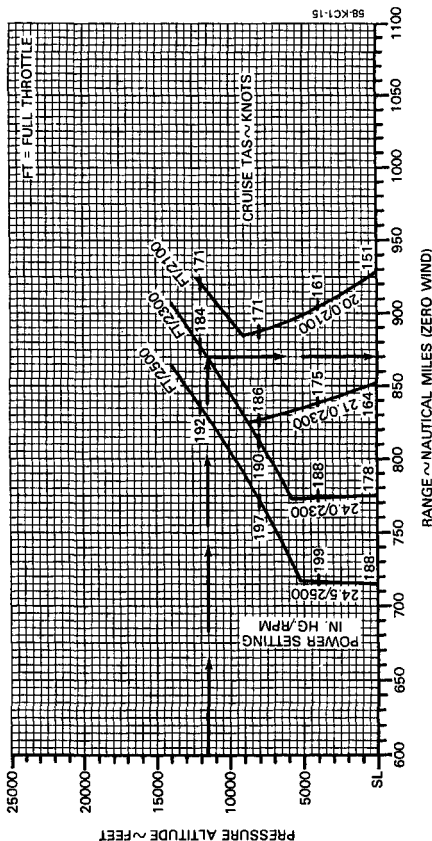

ENDURANCE PROFILE - 136 GALLONS

ASSOCIATED CONDITIONS:

5000 LBS
 AVIATION GASOLINE
 FUEL DENSITY 6.0 LBS/GAL
 INITIAL FUEL LOADING 136 U.S. GALS (816 LBS)

STANDARD DAY (ISA)

EXAMPLE:

PRESSURE ALTITUDE 11500 FEET
 FULL THROTTLE 2300 RPM
 ENDURANCE 4.75 HRS
 (4 HRS. 45 MIN)

NOTE:

ENDURANCE INCLUDES START, TAXI, CLIMB AND DESCENT
 WITH 45 MINUTES RESERVE FUEL AT ECONOMY CRUISE

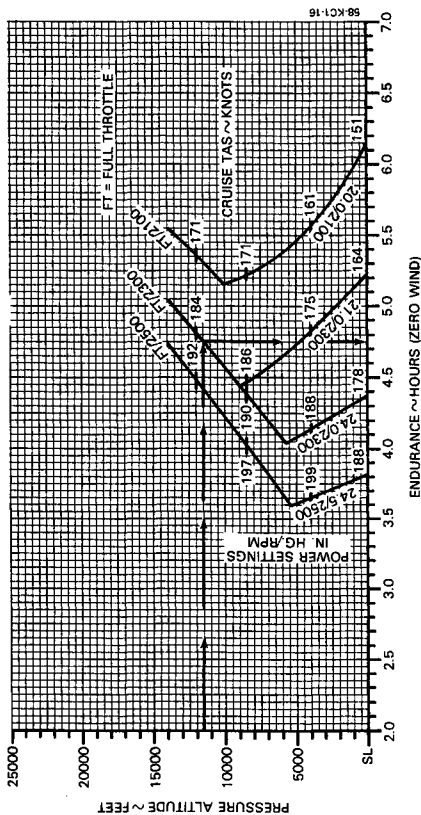

ENDURANCE PROFILE - 166 GALLONS

ASSOCIATED CONDITIONS:

WEIGHT 5000 LBS
 FUEL AVIATION GASOLINE
 FUEL DENSITY 6.0 LBS/GAL
 INITIAL FUEL LOADING 166 U.S. GALS (896 LBS)

STANDARD DAY (ISA)

EXAMPLE:
 PRESSURE ALTITUDE 11500 FEET
 FULL THROTTLE 2300 RPM
 ENDURANCE 6.0 HRS

NOTE:
 ENDURANCE INCLUDES START, TAXI, CLIMB AND DESCENT
 WITH 45 MINUTES RESERVE FUEL AT ECONOMY CRUISE

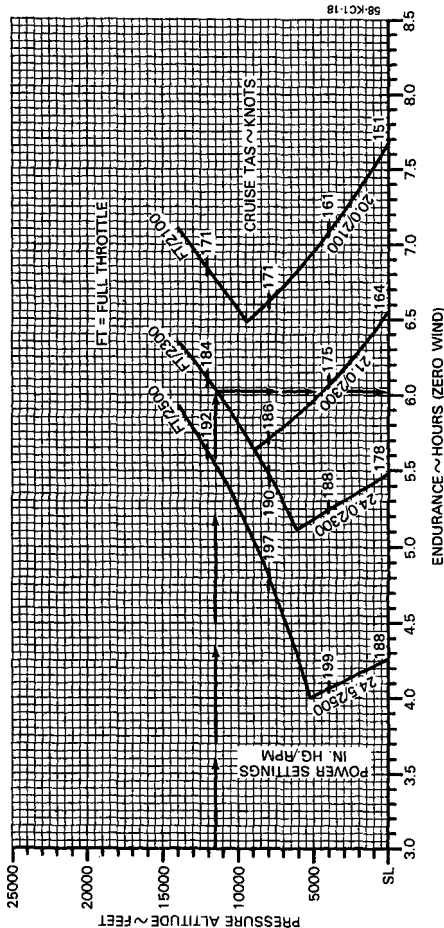

Section V Performance

BEECHCRAFT Baron 58 Serial TH 773 and After

RANGE PROFILE - 194 GALLONS

STANDARD DAY (ISA)

ASSOCIATED CONDITIONS:

WEIGHT 5000 LBS
FUEL AVIATION GASOLINE
FUEL DENSITY 6.0 LBS/GAL
INITIAL FUEL LOADING 194 U.S. GAL (1164 LBS)

EXAMPLE:

PRESSURE ALTITUDE 11500 FEET
FULL THROTTLE
POWER SETTING 2300 RPM

RANGE 1325 NM

NOTE:

RANGE INCLUDES START, TAXI, CLIMB AND DESCENT
WITH 45 MINUTES RESERVE FUEL AT ECONOMY CRUISE

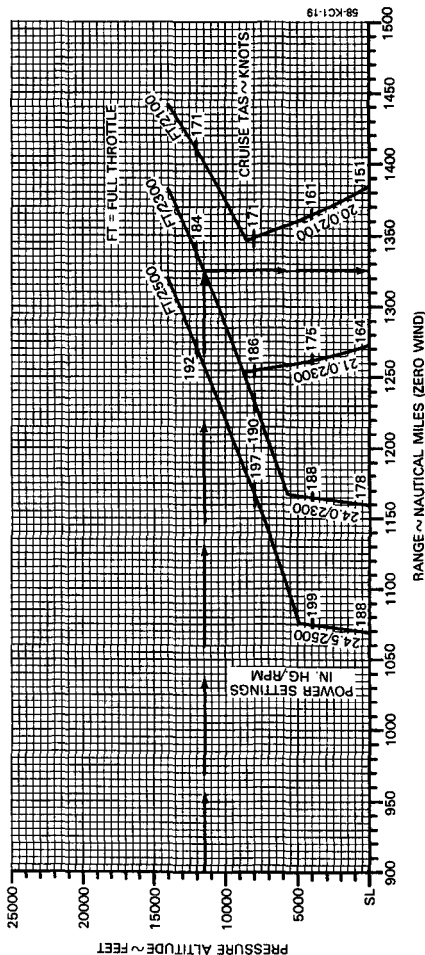

BEECHCRAFT Baron 58 Serial TH 773 and After

Section V Performance

ENDURANCE PROFILE - 194 GALLONS

ASSOCIATED CONDITIONS:

WEIGHT 5000 LBS
FUEL AVIATION GASOLINE
FUEL DENSITY 6.0 LBS/GAL
INITIAL FUEL LOADING 194 U.S. GALS (1164 LBS)

STANDARD DAY (ISA)

EXAMPLE:
PRESSURE ALTITUDE 11500 FEET
POWER SETTING FULL THROTTLE
2300 RPM
ENDURANCE 7.15 HRS
(7 HRS, 9 MIN)

NOTE:
ENDURANCE INCLUDES START, TAXI, CLIMB AND DESCENT
WITH 45 MINUTES RESERVE FUEL AT ECONOMY CRUISE

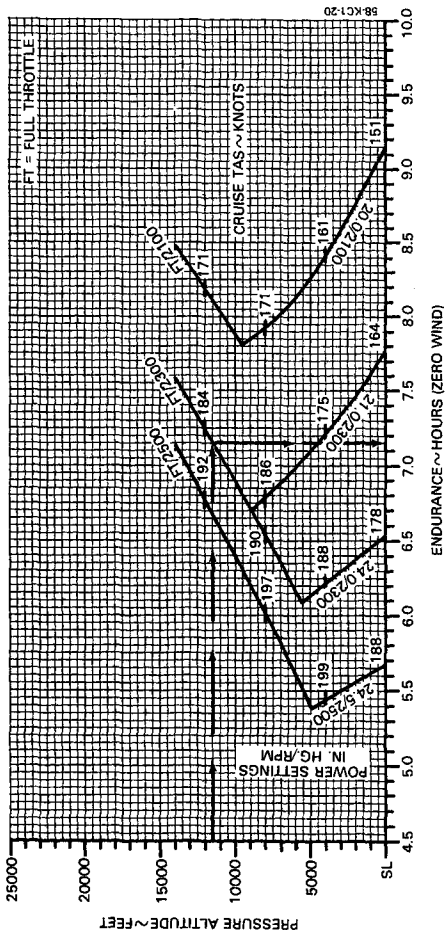

Section V Performance

BEECHCRAFT Baron 58 Serial TH 773 and After

EXAMPLE:
 FUEL AVAILABLE FOR HOLDING 400 LBS
 PRESSURE ALTITUDE 5000 FT
 HOLDING TIME 3.1 HR

HOLDING TIME

ASSOCIATED CONDITIONS:

POWER SETTING 20.5 IN. HG. OR
 FULL THROTTLE
 2100 RPM

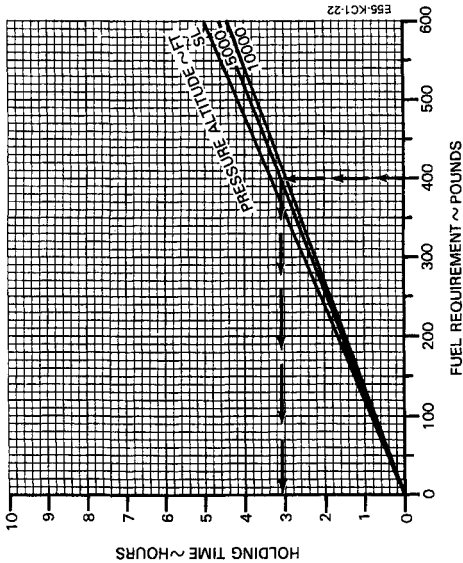

TIME, FUEL AND DISTANCE TO DESCEND

ASSOCIATED CONDITIONS:

POWER AS REQUIRED TO
 MAINTAIN 500 FT/MIN
 RATE-OF-DESCENT
 LANDING GEAR UP
 FLAPS UP

EXAMPLE:

INITIAL ALTITUDE	11500 FT
FINAL ALTITUDE	3965 FT
TIME TO DESCEND	(23-8) = 15 MIN
FUEL TO DESCEND	(9.7-3.3) = 6.4 GAL
DISTANCE TO DESCEND	(72-25) = 47 NM

DESCENT SPEED
 175 KNOTS

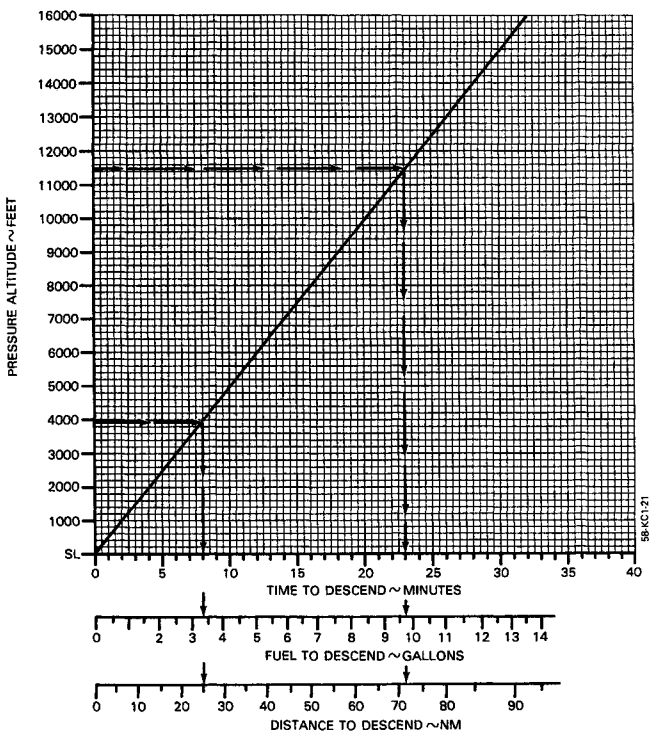

Section V Performance

BEECHCRAFT Baron 58 Serial TH 773 and After

CLIMB-BALKED LANDING

CLIMB SPEED 96 KNOTS (ALL WEIGHTS)

ASSOCIATED CONDITIONS:

- POWER DOWN
- FLAPS DOWN
- LANDING GEAR DOWN TO APPROPRIATE MIXTURE
- FUEL FLOW

EXAMPLE:

OAT 25°C
 PRESSURE ALTITUDE 3965 FT
 WEIGHT 5039
 RATE OF CLIMB 640 FT/MIN
 CLIMB GRADIENT 6.5%

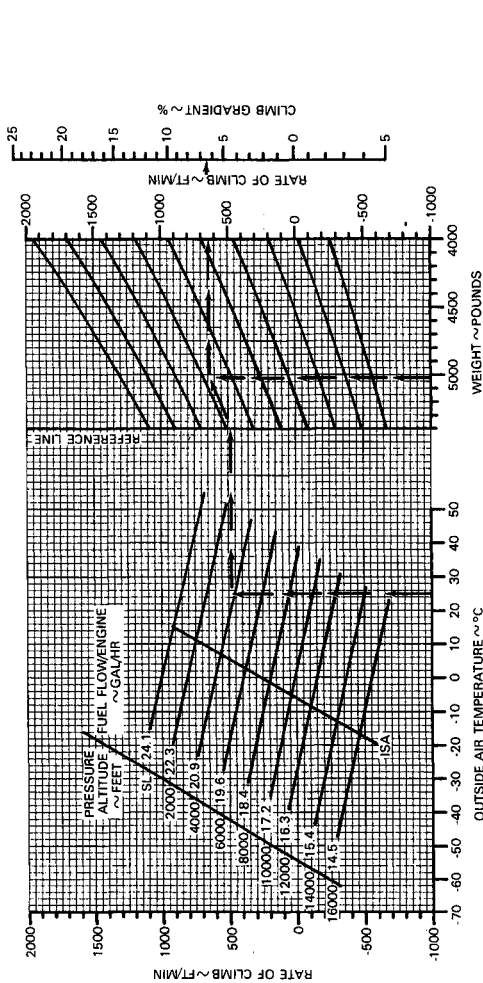

BEECHCRAFT Baron 58 Serial TH 773 and After

Section V Performance

ASSOCIATED CONDITIONS:

POWER RETARDED TO MAINTAIN 800 FT/MIN
ON FINAL APPROACH
FLAPS DOWN
LANDING GEAR DOWN
APPROACH SPEED IAS AS TABULATED
BRACKING MAXIMUM
RUNWAY PAVED, LEVEL, DRY SURFACE

LANDING DISTANCE

WEIGHT POUNDS	SPEED AT 50 FT KNOTS	
	5400	96
5000	91	87
4600	87	81
4000		

EXAMPLE:

OAT 26°C
PRESSURE ALTITUDE 3965 FT
WEIGHT 5039 LBS
WIND COMPONENT 3.5 KTS
GROUND ROLL 1450 FT
TOTAL OVER 50 FT 2500 FT
OBSTACLE 91 KTS
APPROACH SPEED 91 KTS

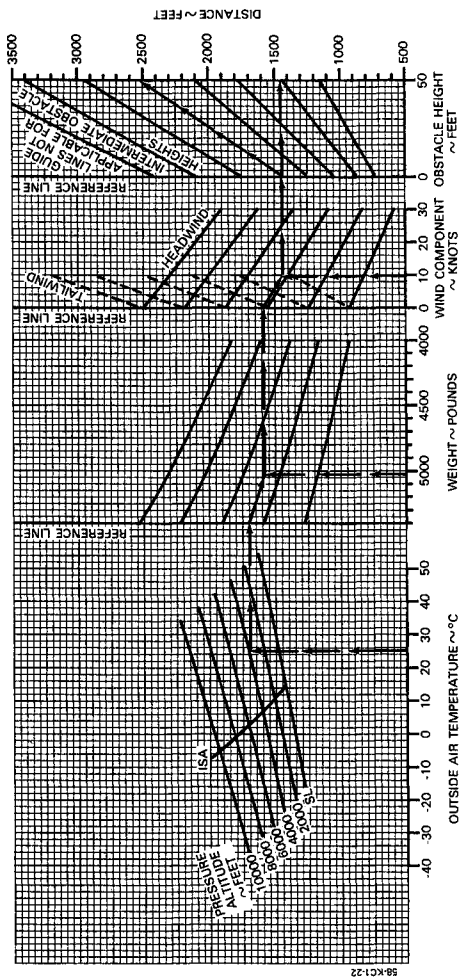

INTENTIONALLY LEFT BLANK

SECTION VI

WEIGHT AND BALANCE/ EQUIPMENT LIST

TABLE OF CONTENTS

<i>SUBJECT</i>	<i>PAGE</i>
Weighing Instructions	6-3
Basic Empty Weight and Balance Form	6-5
Weight and Balance Record	6-7
Seating, Baggage and Equipment	
Arrangements	6-9
Loading Instructions	6-10
Moment Limits vs Weight Table	6-11 - 6-13
Moment Limits vs Weight Graph	6-14
Computing Procedure	6-15
Sample Weight and Balance Loading Form ...	6-16
Weight and Balance Loading Form	6-17
Useful Load Weights and Moments	6-18 - 6-21
Occupants	6-18
Baggage	6-19
Cargo	6-20
Usable Fuel	6-21
Airplane Papers (furnished with individual airplane)	

INTENTIONALLY LEFT BLANK

WEIGHING INSTRUCTIONS

Periodic weighing of the airplane may be required to keep the Basic Empty Weight current. All changes to the airplane affecting weight and balance are the responsibility of the airplane's operator.

1. Three jack points are provided for weighing: two on the wing front spar at Fuselage Station 83.1 and one on the aft fuselage at Fuselage Station 271.0.
2. Fuel should be drained preparatory to weighing. Tanks are drained from the regular drain ports with the airplane in static ground attitude. When tanks are drained, 5.7 pounds of undrainable fuel remain in the airplane at Fuselage Station 81.6. The remainder of the unusable fuel to be added to a drained system is 30.3 pounds at Fuselage Station 78.5
3. Engine oil must be at the full level or completely drained. Total engine oil when full is 45 pounds at Fuselage Station 43.
4. To determine airplane configuration at time of weighing, installed equipment is checked against the airplane equipment list or superseding forms. All installed equipment must be in its proper place during weighing.
5. The airplane must be longitudinally and laterally level with the landing gear fully extended at the time of weighing. Leveling screws are located on the left side of the fuselage at Fuselage Station 152.25 (approximately). Longitudinally level attitude is determined with a plumb bob. Laterally level attitude is accomplished by having the vertical distance, from the left and right wingtips to the floor, equal.

6. Measurement of the reaction arms for a wheel weighing is made using a steel measuring tape. Measurements are taken, with the airplane level on the scales, from the reference (a plumb bob dropped from the center of either main jack point) to the axle center line of the main gear and then to the nose wheel axle center line. The main wheel axle center line is best located by stretching a string across from one main wheel to the other. All measurements are to be taken with the tape level with the hangar floor and parallel to the fuselage center line. The locations of the wheel reactions will be approximately at Fuselage Station 96.7 for main wheels and Fuselage Station -10.3 for the nose wheel.
7. Jack point weighings are accomplished by placing scales at the jack points specified in step 1 above. Since the center of gravity of the airplane is forward of Fuselage Station 83.1, the tail reaction of the airplane will be in an up direction. This can be measured on regular scales by placing ballast of approximately 200 pounds on the scales and attached to the aft weighing point by cable of adjustable length. The up reaction will then be total ballast weight minus the scale reading and is entered in the weighing form as a negative quantity.
8. Weighing should always be made in an enclosed area which is free from air currents. The scales used should be properly calibrated and certified.

LEVELING POINTS

152.25

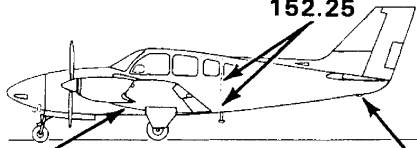

FRONT JACK POINTS
F.S. 83.1

REAR JACK POINT
F.S. 271.0

BASIC EMPTY WEIGHT AND BALANCE

BARON 58 SER. NO. _____ REG. NO. _____ DATE _____
STRUT POSITION - NOSE MAIN JACK POINT LOCATION PREPARED BY
 EXTENDED -11.6 96 FORWARD 83.1 Company _____
 COMPRESSED -9.8 97 AFT 271.0 Signature _____

REACTION WHEEL - JACK POINTS	SCALE READING	TARE	NET WEIGHT	ARM	MOMENT
LEFT MAIN					
RIGHT MAIN					
NOSE OR TAIL					
TOTAL (AS WEIGHED)					
Space below provided for additions and subtractions to as weighed condition					
EMPTY WEIGHT (DRY)					
ENGINE OIL			45	-	1935
UNUSABLE FUEL			36	79	2844
BASIC EMPTY WEIGHT					

NOTE

Each new airplane is delivered with a completed sample loading, empty weight and center of gravity, and equipment list, all pertinent to that specific airplane. It is the owner's responsibility to ensure that changes in equipment are reflected in a new weight and balance and in an addendum to the equipment list. There are many ways of doing this; it is suggested that a running tally of equipment changes and their effect on empty weight and c.g. is a suitable means for meeting both requirements.

The current equipment list and empty weight and c.g. information must be retained with the airplane when it changes ownership. Beech Aircraft Corporation cannot maintain this information; the current status is known only to the owner. If these papers become lost, the FAA will require that the airplane be re-weighed to establish the empty weight and c.g. and that an inventory of installed equipment be conducted to create a new equipment list.

SEATING, BAGGAGE AND EQUIPMENT
ARRANGEMENTS

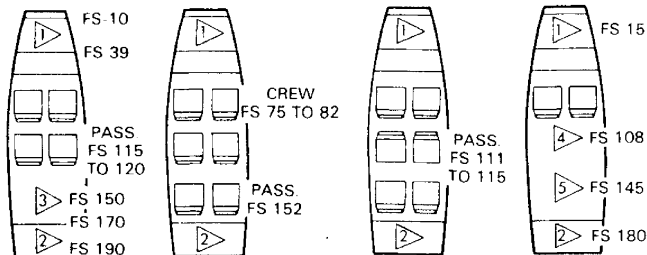

NOTE

The floor structure load limit is 100 pounds per square foot, except for the area between the front and rear spars, where the floor structure load limit is 50 pounds per square foot.

- 1 MAXIMUM WEIGHT 300 POUNDS INCLUDING EQUIPMENT AND BAGGAGE.
- 2 MAXIMUM WEIGHT 120 POUNDS INCLUDING EQUIPMENT AND BAGGAGE.
- 3 MAXIMUM WEIGHT 400 POUNDS INCLUDING EQUIPMENT AND BAGGAGE.
- 4 MAXIMUM WEIGHT 200 POUNDS FORWARD OF REAR SPAR INCLUDING EQUIPMENT AND CARGO WITH 3rd and 4th SEATS REMOVED. ALL CARGO MUST BE SECURED WITH APPROVED CARGO RETENTION NETS.
- 5 MAXIMUM WEIGHT 400 POUNDS AFT OF REAR SPAR INCLUDING EQUIPMENT AND CARGO WITH 3rd, 4th, 5th and 6th SEATS REMOVED.

LOADING INSTRUCTIONS

It is the responsibility of the airplane operator to ensure that the airplane is properly loaded. At the time of delivery, Beech Aircraft Corporation provides the necessary weight and balance data to compute individual loadings. All subsequent changes in airplane weight and balance are the responsibility of the airplane owner and/or operator.

The empty weight and moment of the airplane at the time of delivery are shown on the airplane Empty Weight and Balance form. Useful load items which may be loaded into the airplane are shown on the Useful Load Weight and Moment tables. The minimum and maximum moments are indicated on the Moment Limits vs Weight table. These moments correspond to the forward and aft center of gravity flight limits for a particular weight. All moments are divided by 100 to simplify computations.

MOMENT LIMITS vs WEIGHT

Moment limits are based on the following weight and center of gravity limit data (landing gear down).

WEIGHT CONDITION	FORWARD CG LIMIT	AFT CG LIMIT
5400 lb. (58 max. take-off or landing)	78.0	86.0
4990 lb. (58A max. take-off or landing)	76.6	86.0
4200 lb. or less	74.0	86.0

BEECHCRAFT Baron 58
Serial TH 773 and After

Section VI
Wt and Bal/Equip List

Weight	<u>Minimum</u> <u>Moment</u> 100	<u>Maximum</u> <u>Moment</u> 100
3400	2516	2924
3425	2535	2946
3450	2553	2967
3475	2572	2989
3500	2590	3010
3525	2609	3032
3550	2627	3053
3575	2646	3075
3600	2664	3096
3625	2683	3118
3650	2701	3139
3675	2720	3161
3700	2738	3182
3725	2757	3204
3750	2775	3225
3775	2794	3247
3800	2812	3268
3825	2831	3290
3850	2849	3311
3875	2868	3333
3900	2886	3354
3925	2905	3376
3950	2923	3397
3975	2942	3419
4000	2960	3440
4025	2979	3462
4050	2997	3483
4075	3016	3505

MOMENT LIMITS vs WEIGHT (Continued)

Weight	<u>Minimum Moment</u> 100	<u>Maximum Moment</u> 100
4100	3034	3526
4125	3053	3548
4150	3071	3569
4175	3090	3591
4200	3108	3612
4225	3130	3634
4250	3152	3655
4275	3174	3677
4300	3196	3698
4325	3218	3720
4350	3240	3741
4375	3263	3763
4400	3285	3784
4425	3308	3806
4450	3330	3827
4475	3352	3849
4500	3374	3870
4525	3398	3892
4550	3420	3913
4575	3442	3935
4600	3465	3956
4625	3488	3978
4650	3510	3999
4675	3534	4021
4700	3556	4042
4725	3579	4064
4750	3602	4085
4775	3625	4107

MOMENT LIMITS vs WEIGHT (Continued)

Weight	<u>Minimum</u> <u>Moment</u> 100	<u>Maximum</u> <u>Moment</u> 100
4800	3648	4128
4825	3671	4150
4850	3694	4171
4875	3717	4193
4900	3740	4214
4925	3764	4236
4950	3786	4257
4975	3810	4279
4990	3824	4291
5000	3833	4300
5025	3856	4322
5050	3880	4343
5075	3904	4365
5100	3926	4386
5125	3950	4408
5150	3974	4429
5175	3998	4451
5200	4021	4472
5225	4045	4494
5250	4068	4515
5275	4092	4537
5300	4116	4558
5325	4140	4580
5350	4164	4601
5375	4188	4622
5400	4212	4644

Section VI
Wt and Bal/Equip List

BEECHCRAFT Baron 58
Serial TH 773 and After

MOMENT LIMITS vs WEIGHT

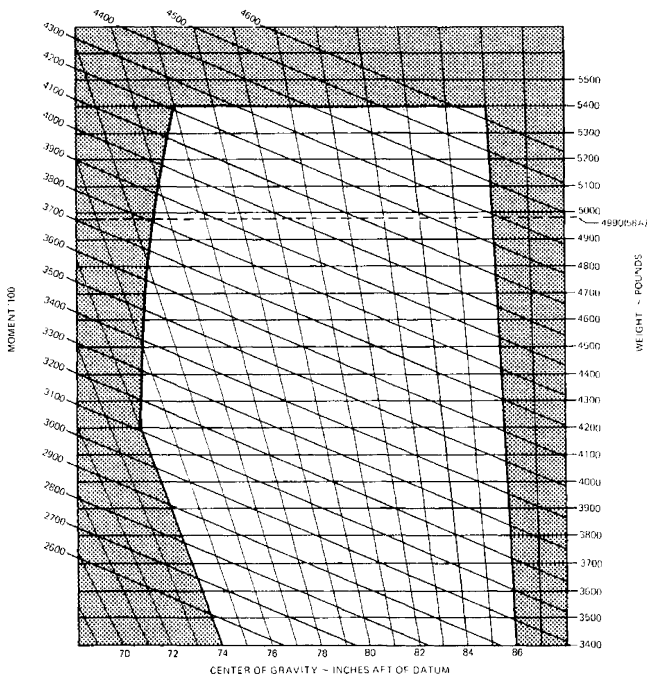

ENVELOPE BASED ON THE FOLLOWING WEIGHT AND
 CENTER OF GRAVITY LIMIT DATA (LANDING GEAR DOWN)

BARON 58

<u>WEIGHT CONDITION</u>	<u>FORWARD C.G. LIMIT</u>	<u>AFT C.G. LIMIT</u>
5400 LBS (MAXIMUM TAKE OFF OR LANDING)	78.0	86.0
4200 LBS	74.0	86.0

BARON 58A

<u>WEIGHT CONDITION</u>	<u>FORWARD C.G. LIMIT</u>	<u>AFT C.G. LIMIT</u>
4990 LBS (MAXIMUM TAKE OFF OR LANDING)	76.6	86.0
4200 LBS	74.0	86.0

10-1018-10

COMPUTING PROCEDURE

1. Record the Basic Empty Weight and Moment from the Basic Empty Weight and Balance form (or from the latest superseding form) under the Basic Empty Condition block. The moment must be divided by 100 to correspond to Useful Load Weights and Moments tables.
2. Record the weight and corresponding moment from the appropriate table of each of the useful load items (except fuel) to be carried in the airplane.
3. Total the weight column and moment column. The SUB-TOTAL is the Zero Fuel Condition.
4. Determine the weight and corresponding moment for the fuel loading to be used. This fuel loading includes fuel for the flight, plus that required for start, taxi, and take-off. Add the Fuel to Zero Fuel Condition to obtain the SUB-TOTAL Ramp Condition.
5. Subtract the fuel to be used for start and taxi to arrive at the SUB-TOTAL Take-off Condition.
6. Subtract the weight and moment of the fuel to be used from the take-off weight and moment. (Determine the weight and moment of this fuel by subtracting the amount on board on landing from the amount on board on take-off.) The Zero Fuel Condition, the Take-Off Condition, and the Landing Condition moment must be within the minimum and maximum moments shown on the Moment Limit vs Weight table for that weight. If the total moment is less than the minimum moment allowed, useful load items must be shifted aft or forward load items reduced. If the total moment is greater than the maximum moment allowed, useful load items must be shifted forward or aft load items reduced. If the quantity or location of load items is changed, the calculations must be revised and the moments rechecked.

Section VI
Wt and Bal/Equip List

BEECHCRAFT Baron 58
Serial TH 773 and After

The following Sample Loading chart is presented to depict the sample method of computing a load. Weights used DO NOT reflect an actual airplane loading.

WEIGHT AND BALANCE LOADING FORM

BARON 58 **DATE** _____

SERIAL NO. TH-XXXX **REG NO.** NXXX

ITEM	WEIGHT	MOM/100
1. BASIC EMPTY CONDITION	3517	2763
2. FRONT SEAT OCCUPANTS	340	256
3. 3rd and 4th SEAT OCCUPANTS FWD FACING	-	-
4. 3rd and 4th SEAT OCCUPANTS AFT FACING	340	378
5. 5th and 6th SEAT OCCUPANTS	170	258
6. NOSE BAGGAGE	61	9
7. AFT BAGGAGE	-	-
8. CARGO	-	-
9. SUB TOTAL ZERO FUEL CONDITION	4428	3664
10. FUEL LOADING (166 GAL)	996	824
11. SUB TOTAL RAMP CONDITION	5424	4488
12. *LESS FUEL FOR START, TAXI, AND TAKE-OFF	-24	-20
13. SUB TOTAL TAKE-OFF CONDITION	5400	4468
14. LESS FUEL TO DESTINATION (142 GAL)	-852	-712
15. LANDING CONDITION	4548	3756

SAMPLE

*Fuel for start, taxi and take-off is normally 24 lbs at an average mom/100 of 20.

WEIGHT AND BALANCE LOADING FORM

BARON _____ **DATE** _____

SERIAL NO. _____ **REG NO.** _____

ITEM	WEIGHT	MOM/100
1. BASIC EMPTY CONDITION		
2. FRONT SEAT OCCUPANTS		
3. 3rd and 4th SEAT OCCUPANTS FWD FACING		
4. 3rd and 4th SEAT OCCUPANTS AFT FACING		
5. 5th and 6th SEAT OCCUPANTS		
6. NOSE BAGGAGE		
7. AFT BAGGAGE		
8. CARGO		
9. SUB TOTAL ZERO FUEL CONDITION		
10. FUEL LOADING		
11. SUB TOTAL RAMP CONDITION		
12. *LESS FUEL FOR START, TAXI, AND TAKE-OFF		
13. SUB TOTAL TAKE-OFF CONDITION		
14. LESS FUEL TO DESTINATION		
15. LANDING CONDITION		

*Fuel for start, taxi and take-off is normally 24 lbs at an average mom/100 of 20.

USEFUL LOAD WEIGHTS AND MOMENTS
OCCUPANTS

WEIGHT	Front Seats		Standard Seating 3rd and 4th Fwd Facing		Club Seating 3rd and 4th Aft Facing		5th and 6th Seats
	Fwd Position	Aft Position	Fwd Position	Aft Position	Fwd Position	Aft Position	Standard or Club Seating
	ARM 75	ARM 82	ARM 115	ARM 120	ARM 111	ARM 115	ARM 152
MOM/100							
100	75	82	115	120	111	115	152
110	82	90	126	132	122	126	167
120	90	98	138	144	133	138	182
130	98	106	150	156	144	150	198
140	105	114	161	168	155	161	212
150	112	123	172	180	166	172	228
160	120	131	184	192	178	184	243
170	128	139	196	204	188	196	258
180	135	148	207	216	200	207	274
190	142	156	218	228	210	218	288
200	150	164	230	240	222	230	304

NOTE: OCCUPANT POSITIONS SHOWN ARE FOR THE SEATS ADJUSTED THE MAXIMUM RANGE. INTERMEDIATE POSITIONS WILL REQUIRE INTERPOLATION OF THE MOM/100 VALUES.

BAGGAGE

Weight	NOSE	REAR	AFT
	COMPT	FS 131 TO 170	FS 170 TO 190
	ARM 15	ARM 150	ARM 180
	Mom/100	Mom/100	Mom/100
10	2	15	18
20	3	30	36
30	5	45	54
40	6	60	72
50	8	75	90
60	9	90	108
70	11	105	126
80	12	120	144
90	14	135	162
100	15	150	180
110	17	165	198
120	18	180	216
130	20	195	
140	21	210	
150	23	225	
160	24	240	
170	26	255	
180	27	270	
190	29	285	
200	30	300	
220	33	330	
240	37	360	
260	39	390	
280	42	420	
300	45	450	
320		480	
340		510	
360		540	
380		570	
400		600	

CARGO
FWD OF SPAR
(CENTER SEATS REMOVED)
ARM 108

Weight	<u>Moment</u> 100	Weight	<u>Moment</u> 100
10	11	110	119
20	22	120	130
30	32	130	140
40	43	140	151
50	54	150	162
60	65	160	173
70	76	170	184
80	86	180	194
90	97	190	205
100	108	200	216

CARGO
AFT OF SPAR
(CENTER & AFT SEATS REMOVED)
ARM 145

Weight	<u>Moment</u> 100	Weight	<u>Moment</u> 100
10	15	150	218
20	29	160	232
30	44	170	247
40	58	180	261
50	73	190	276
60	87	200	290
70	102	210	305
80	116	220	319
90	131	230	334
100	145	240	348
110	160	250	363
120	174	260	377
130	189	270	392
140	203	280	406

BEECHCRAFT Baron 58
Serial TH 773 and After

Section VI
Wt and Bal/Equip List

Weight	<u>Moment</u> 100	Weight	<u>Moment</u> 100
290	421	350	508
300	435	360	522
310	450	370	537
320	464	380	551
330	479	390	566
340	493	400	580

USABLE FUEL

		136 GAL	166 GAL	194 GAL
Gallons	Weight	Mom/100		
10	60	46	46	46
20	120	92	92	92
30	180	140	140	140
40	240	189	189	189
50	300	238	238	238
60	360	288	288	288
70	420	338	338	338
80	480	388	388	388
90	540	439	439	439
100	600	489	489	489
110	660	539	539	539
120	720	590	590	590
130	780	641	641	641
136	816	671		
140	840		692	692
150	900		743	743
160	960		793	793
166	996		824	
170	1020			845
180	1080			899
190	1140			953
194	1164			974

INTENTIONALLY LEFT BLANK

SECTION VII

SYSTEMS DESCRIPTION

TABLE OF CONTENTS

<i>SUBJECT</i>	<i>PAGE</i>
Airframe.....	7-5
Flight Controls.....	7-5
Control Surfaces	7-5
Control Column	7-5
Rudder Pedals	7-5
Trim Controls.....	7-6
Electric Elevator Trim	7-6
Instrument Panel.....	7-6
Flight Instruments.....	7-6
Power Plant Instruments	7-7
Ground Control.....	7-7
Wing Flaps	7-7
Panel Illustration.....	7-8, 7-9
Landing Gear System	7-10
Control Switch	7-10
Position Indicators.....	7-10
Safety Switch	7-11
Warning Horn	7-11
Manual Extension.....	7-11
Brakes.....	7-12
Baggage/Cargo Compartments	7-13
Aft Baggage/Cargo Compartment	7-13
Nose Baggage/Cargo Compartment	7-13
Seating	7-14
Seat Belts and Shoulder Harnesses	7-14

TABLE OF CONTENTS (Continued)

<i>SUBJECT</i>	<i>PAGE</i>
Doors, Windows, and Exits	7-15
Cabin Door	7-15
Utility Door.....	7-16
Openable Cabin Windows.....	7-17
Emergency Exits	7-18A
Control Locks.....	7-18A
Power Plants.....	7-18B
Power Plant Controls	7-18B
Propeller, Throttle and Mixture	7-18B
Induction Air.....	7-18B
Engine Ice Protection.....	7-18B
Lubrication System	7-19
Cowl Flaps	7-19
Propellers	7-19
Hartzell Air-Charged Propeller Domes	7-20
Propeller Synchronizer.....	7-20
Propeller Synchroscope	7-21
Fuel System.....	7-21
Fuel Flow and Pressure Indicator	7-22A
Fuel Flow Indicator	7-22B
Illustrations.....	7-22A, 7-23
Fuel Crossfeed.....	7-27
Auxiliary Fuel Pumps.....	7-27
Fuel Off-loading.....	7-27
Fuel Required for Flight.....	7-27
Electrical System	7-28
Battery.....	7-28
Schematic	7-29
Alternators (TH-773 thru TH-1376).....	7-28
Alternators (TH-1377 and After, and Airplanes Equipped With Kit No. 55-3024).....	7-30
Starters	7-31
External Power.....	7-31

TABLE OF CONTENTS (Continued)

<i>SUBJECT</i>	<i>PAGE</i>
Lighting Systems	7-32
Interior Lighting	7-32
Exterior Lighting	7-32A
Heating and Ventilation System	7-33
Cabin Heating	7-33
Environmental Schematic	7-33
Heater Operation	7-34
Heat Regulation	7-35
Heater Blower	7-35
Cabin Ventilation	7-35
Individual Fresh Air Outlets	7-36
Oxygen System	7-36
Pitot and Static System	7-37
Pitot System	7-37
Static System	7-37
Pressure System	7-38
Stall Warning	7-39
Ice Protection Systems	7-40
Surface Deice System	7-40
Windshield Anti-ice (Electrothermal)	7-40A
Propeller and Windshield	
Anti-ice System (Fluid Flow)	7-41
Electrothermal Propeller Deice	7-42
Pitot Heat	7-42
Stall Warning Anti-ice	7-42
Heated Fuel Vents	7-43
Engine Break-In Information	7-43

INTENTIONALLY LEFT BLANK

AIRFRAME

The BEECHCRAFT BARON 58 is a four to six place all-metal, low-wing, twin-engine airplane with retractable tricycle landing gear, and a conventional horizontal and vertical stabilizer.

FLIGHT CONTROLS

CONTROL SURFACES

Control surfaces are bearing supported and operated through push-pull rods and conventional cable systems terminating in bellcranks.

CONTROL COLUMN

The throw-over type control column for elevator and aileron control can be placed in front of either front seat. Pull the T-handle latch at the back of the control arm and position the control wheel as desired. Check for full freedom of movement after repositioning the control.

NOTE

If a reduced power throttle position exists when throwing over the control column, it will be necessary to momentarily move the throttle levers forward for passage of the control column.

The optional dual control column is required for flight instruction.

RUDDER PEDALS

To adjust the rudder pedals, press the spring-loaded lever on the side of each pedal arm and move the pedal to its forward or aft position. The adjustment lever can also be used to place the right set of rudder pedals against the floor, (when the copilot brakes are not installed) when not in use.

TRIM CONTROLS

Trim tabs on the rudder, left aileron, and elevator are adjustable with the controls mounted on the center console through closed cable systems. Mechanical position indicators for each of the trim tabs are integrated with their respective controls. The left aileron tab incorporates servo action in addition to its trimming purpose. Elevator trim is accomplished through either the electric or the manual pitch trim system.

ELECTRIC ELEVATOR TRIM

The electric elevator trim system is controlled by the ON-OFF switch located on the instrument panel, a thumb switch on the control wheel and a circuit breaker on the left sidewall. The ON-OFF switch must be in the ON position to operate the system. The thumb switch is moved forward for nose down, aft for nose up and when released returns to the center OFF position. When the system is not being electrically actuated, the manual trim control wheel may be used.

Incorporated in the system is an emergency release button located on the left handle grip of the pilot's control wheel. This button can be depressed to deactivate the system quickly in case of a malfunction in the system. The system will remain deactivated only while the release button is being held in the depressed position.

INSTRUMENT PANEL

FLIGHT INSTRUMENTS

The flight instruments are located on a floating panel directly in front of the pilot's seat. Standard flight instrumentation includes attitude and directional gyros, air-

speed, altimeter, vertical speed, turn coordinator, and a clock. A magnetic compass is mounted above the instrument panel and an outside air temperature indicator is located on the left side panel. Located on the right side of the instrument panel is the standard pressure gage for the instrument air system.

POWER PLANT INSTRUMENTS

Most of the engine instruments are located in the upper center of the instrument panel. The standard indicators for each engine are as follows: tachometers, manifold pressure, fuel flow, fuel quantity, and loadmeters. Other indicators such as the exhaust gas temperature system, the propeller deice ammeter (or propeller alcohol quantity and deice pressure) are usually installed on the right side of the instrument panel. Two multi-purpose instruments, one for each engine, indicate cylinder head temperature, oil pressure, and oil temperature.

GROUND CONTROL

Spring-loaded linkage from the nose gear to the adjustable rudder pedals allows for nose wheel steering. Smooth turning is accomplished by allowing the airplane to roll while depressing the appropriate rudder pedal. The minimum wing tip turning radius, using partial braking action and differential power, is 31 feet 6 inches.

WING FLAPS

The wing flaps have three positions; UP, 15° (approach), and DOWN (30°), with no intermediate positions. A flap position indicator and a control switch are located on the left side of the control console. The switch must be pulled out of a detent to change the flap position. The flaps will move to either position selected from any previously selected position.

Section VII
Systems Description

BEECHCRAFT Baron 58
Serial TH 773 and After

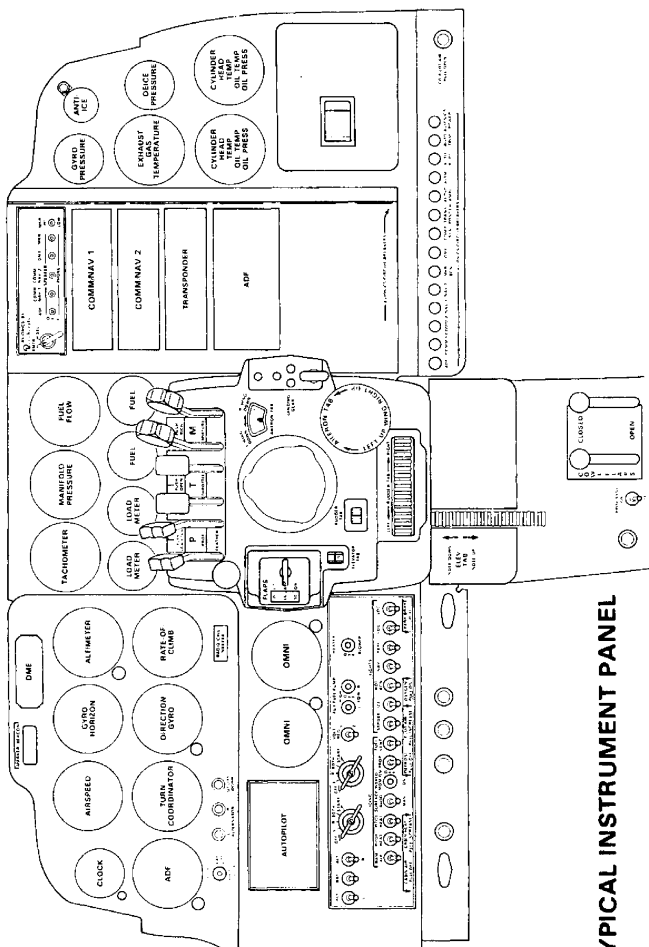

TYPICAL INSTRUMENT PANEL

LANDING GEAR SYSTEM

CAUTION

Never taxi with a flat strut.

The landing gear is operated through adjustable linkage connected to an actuator assembly mounted beneath the front seats. The actuator assembly is driven by an electric motor. The landing gear may be electrically retracted and extended, and may be extended manually.

CONTROL SWITCH

The landing gear is controlled by a two-position switch on the right side of the control console. The switch handle must be pulled out of the safety detent before it can be moved to the opposite position. Never operate the landing gear electrically with the handcrank engaged.

CAUTION

Do not change the position of the control switch to reverse the direction of the landing gear while the gear is in transit, as this could cause damage to the retract mechanism.

POSITION INDICATORS

Landing gear position lights are located above the control switch. Three green lights, one for each gear, are illuminated whenever the landing gears are down and locked. The red light illuminates anytime one or all of the landing gears are in transit or in any intermediate position. All of the lights will be extinguished when the landing gear is up and locked.

The switch placarded TEST-BRT-DIM-WARN LIGHTS, located on the pilot's floating instrument panel, controls the illumination intensity and testing of the lamps. When the switch is held to the TEST position, the warning lights and the landing gear position indicator lights are energized in

order to verify that they illuminate. The switch returns to the BRT position. The pilot may select BRT or DIM lights by moving the switch to the proper position.

SAFETY SWITCH

To prevent inadvertent retraction of the landing gear on the ground, a main strut safety switch opens the control circuit when the strut is compressed.

CAUTION

Never rely on the safety switch to keep the gear down during taxi or on takeoff , landing roll, or in a static position. Always make certain that the landing gear switch is in the down position during these operations.

WARNING HORN

If either or both throttles are retarded below an engine setting sufficient to sustain two engine flight with the landing gear retracted, a warning horn will sound intermittently. During one engine operation, the horn can be silenced by advancing the throttle of the inoperative engine until the throttle warning horn switch opens the circuit.

MANUAL EXTENSION

The landing gear can be manually extended, but not retracted, by operating the handcrank on the rear of the pilot's seat. The landing gear handle must be in the down position and the landing gear MOTOR circuit breaker must be pulled before manually extending the gear. When the electrical system is operative, the landing gear may be checked for full down with the gear position lights, provided the landing gear RELAY circuit breaker is engaged. After the landing gear is down, disengage the handcrank. For electrical retraction of the landing gear after a practice manual extension use procedures outlined in the EMERGENCY PROCEDURES section.

If the landing gear was extended for emergency reasons, do not move any landing gear controls or reset any switches or circuit breakers until the aircraft is on jacks, to prevent a gear retraction on the ground. These procedures are outlined in the EMERGENCY PROCEDURES section.

BRAKES

The brakes on the main landing gear wheels are operated by applying toe pressure to the top of the rudder pedals. The parking brake T-handle control is located just left of the elevator tab wheel on the pilot's subpanel. To set the parking brakes, pull the control out and depress each toe pedal until firm. Push the control in to release the brakes.

NOTE

The parking brake should remain off and wheel chocks installed if the airplane is to remain unattended. Changes in ambient temperature can cause the brakes to release or to exert excessive pressure.

On Serials TH-773 thru TH-1005 with shuttle valves installed, only the pilot's brake pedals can be used in conjunction with the parking brake system to set the parking brake.

CAUTION

On Serials TH-773 thru TH-1005 with shuttle valve brake systems installed, continuous brake application of either the pilot's or copilot's brake pedals, in conjunction with an overriding pumping action from the opposite brake pedals, could result in the loss of braking action on the side which continuous pressure is being applied.

The brakes hydraulic fluid reservoir is accessible through the nose baggage door. Fluid level is checked with the dipstick attached to the reservoir cap. The brakes require no adjustments, since the pistons move outward to compensate for lining wear.

BAGGAGE/CARGO COMPARTMENTS

AFT BAGGAGE/CARGO COMPARTMENT

The aft baggage/cargo compartment is accessible through the utility door on the right side of the fuselage. This area extends aft of the pilot's seats to the rear bulkhead. Because of structural limitations, this area is divided into three sections, each having a different weight limitation. Loading within the baggage/cargo compartment must be in accordance with the data in the WEIGHT AND BALANCE section. All cargo must be secured with approved cargo retention nets.

WARNING

Do not carry hazardous material anywhere in the airplane.

NOSE BAGGAGE/CARGO COMPARTMENT

The forward baggage/cargo compartment is easily accessible through a large door on the right side of the nose. The door, hinged at the top, swings upward, clear of the loading area. Loading within this area must be within the limitations according to the WEIGHT AND BALANCE section. The nose baggage/cargo compartment incorporates the full width of the fuselage as usable space. This compartment also affords accessibility to the oxygen cylinder and to some of the airplane's avionics. Straps are provided and should be used to secure any baggage or cargo loaded into the nose baggage/cargo compartment.

SEATING

To adjust any of the four standard seats forward or aft, pull up on the release bar below the seat and slide the seat to the desired position. The seat backs of all standard seats can be placed in any of four positions by operating a release lever on the inboard side of each seat. An option is available that provides for the seat backs on all seats (except the pilot's) to be placed in any position from vertical to fully reclined. Outboard armrests for all standard seats are built into the cabin sidewalls. Center armrests can be elevated or positioned flush with the seat cushions. The 3rd and 4th place chairs are equipped with a locking back to accommodate the shoulder harness, and the seat back can be folded over for access by rotating the red handle located on the lower inboard side of the seat back. The optional fifth and sixth seats can be folded up to provide additional floor space, or folded down to provide access to the extended baggage/cargo compartment.

Club seating is available. When occupied, aft facing chairs in the club seating arrangement must have the headrests in the fully raised position during takeoff and landing. If desired, these seats can be arranged to face forward. To convert aft facing club seats to forward facing, move seat stops on center tracks to the two forward existing holes. Move stops on outboard and inboard tracks to the existing aft holes.

SEAT BELTS AND SHOULDER HARNESSSES

The shoulder harness is a standard installation for all seats and must be used with the seats in the upright position. The spring loading at the inertia reel keeps the harness snug but will allow normal movement during flight operations. The inertia reel is designed with a locking device that will secure the harness in the event of sudden forward movement or an impact action.

The strap is worn over the shoulder and down across the body, where it is fastened by a metal loop into the seat belt buckle. For the pilot seats, the harness strap is contained in an inertia reel attached to the side canopy structure of the cockpit. The inertia reel is covered with an escutcheon and the strap runs up from the reel location to a looped fitting attached to the window frame just aft of the pilot seats. For the third and fourth passenger seats, the inertia reel is attached into the seat back structure and is covered with the seat back upholstery. The strap runs up the seat back and over the outboard corner of the seat back. For the fifth and sixth passenger seats, the strap is contained in an inertia reel attached to the upper fuselage side structure, just aft of the seat back and is covered with an escutcheon.

NOTE

The seat belt is independent of the shoulder harness, but the outboard seat belt and the shoulder harness must be connected for stowage when the seat is not occupied.

DOORS, WINDOWS AND EXITS

CABIN DOOR

The airplane has a conventional cabin door on the forward right side of the fuselage and when closed, the outside cabin door handle is spring loaded to fit into a recess in the door to create a flat aerodynamically clean surface. The door may be locked with a key. To open the door from the outside, lift the handle from its recess and pull until the door opens.

To close the cabin door from the inside, observe that the door handle is in the unlocked position. In this position, the latch handle is free to move approximately one inch in either direction before engagement of the locking

mechanism. Then grasp the door and firmly pull the door closed. Rotate the door handle fully counterclockwise into the locked position. When the door is properly locked, the door latch handle is free to move approximately one inch in either direction.

NOTE

When checking the door latch handle, do not move it far enough to engage the door latch release mechanism.

Press firmly outward at the top rear corner of the door. If any movement of the door is detected, completely open the door and close again following the above instructions.

To open the door from the inside, depress the lock button and rotate the handle clockwise.

UTILITY DOOR

A utility door aft of the cabin door is provided for loading bulky cargo or to accommodate passengers. The utility door is a double door with each half hinged at the forward and aft edge of the door opening. The rear half of the door must be closed first. A latch on the forward edge of the door moves downward to a locked position to secure the hooks at the top and bottom of the door to the door frame. The front half of the door cannot be fully closed until the latch of the aft door is latched and flush with the edge of the door. After the forward half of the door is closed, it can be latched from the outside by rotating the half-moon shaped handle to the CLOSED position. A conventional handle on the inside of this door provides for opening or closing from the inside.

A BEECH approved kit is available to provide for operation with the cargo doors removed. A baffle is to be installed on the forward edge of the door and placards installed in the airplane. With the doors removed, assure that all regis-

tration numbers are visible on the side of the airplane. With doors removed, all occupants not wearing parachutes must wear restraining belts.

The utility door ajar warning light is tested by the TEST-BRT-DIM-WARN LIGHTS switch, located on the pilot's floating instrument panel. The switch controls the intensity and testing of the lamps. When the switch is held in the TEST position, the light is energized in order to verify that it illuminates. The switch, when released, returns to the BRT position. The pilot may select either BRT or DIM lights by moving the switch to the desired position.

OPENABLE CABIN WINDOWS

NOTE

Windows are to be closed before and during flight.

Serials TH-773 thru TH-1079, Except TH-1027, TH-1062 and TH-1067:

To Open Window For Ventilation (Only On Ground):

Release latch front of bar, pull bar at the bottom of the window out and upward. Window will open approximately two inches.

To Close Window:

Pull inward and down on the bar at the bottom of the window. Resistance will be felt as the bar moves downward. Continue moving bar downward to its lowest position. Check that bar is locked by the latch.

NOTE

While closing window, ascertain that the emergency release pin (which allows the window to open fully for emergency exit) is securely in place.

Section VII
Systems Description

BEECHCRAFT Baron 58
Serial TH 773 and After

Serials TH-1027, TH-1062, TH-1067 and TH-1080 thru TH-1315:

A plastic covered multi-purpose latch on each openable window is used to provide partial opening of the window for ventilation during ground operations, and also quick unlatching for emergency egress.

To Open Window For Ventilation (Only On Ground):

NOTE

Red handle for emergency exit only.

1. Lift thumb catch (window will release).
2. Push up and outward until mechanism clicks into detent.

To Close Window:

— Pull inward and down until locked. (Listen for detent.)

Serials TH-1316 and after:

To Open Window For Ventilation (Only On Ground):

NOTE

Red handle for emergency exit only.

1. Rotate lock handle to UNLOCKED position.
2. Lift thumb catch (window will release).
3. Push latch up and outward to over-center position.

To Close Window:

1. Pull latch inward and push down until locked. (Listen for detent.)
2. Rotate lock handle to LOCKED position.

EMERGENCY EXITS

To open the emergency exit provided by the openable window on each side of the cabin:

Serials TH-773 thru TH-1079, Except TH-1027, TH-1062 and TH-1067:

1. Lift the latch.
2. Pull out the emergency release pin and push the window out.

The above procedure is described on a placard installed below the left and right openable windows.

Serials TH-1027, TH-1062, TH-1067, TH-1080 and after:

1. Remove cover as indicated by placard in the center of the Ventilation/Emergency Exit latch.
2. Rotate handle up as indicated by placard, breaking safety wire, and push window out.

NOTE

Anytime the window has been opened by breaking the safety wire on the red emergency latch, the window must be reattached and wired by a qualified mechanic using QQ-W-343, Type S, .020 diameter copper wire prior to further airplane operation.

CONTROL LOCKS

The control column pin assembly is placarded with the installation instructions. Install the assembly with the instructions facing the instrument panel. Placard reading **CONTROLS LOCKED, REMOVE BEFORE FLIGHT** will be facing pilot if properly installed.

POWER PLANTS

The BEECHCRAFT BARON 58 is powered by two Continental IO-520-C or IO-520-CB six-cylinder, horizontally opposed, fuel-injected engines rated at 285 hp at 2700 rpm.

POWER PLANT CONTROLS

PROPELLER, THROTTLE, AND MIXTURE

The control levers are grouped along the upper face of the control console. Their knobs are shaped so they can be identified by touch. A single controllable friction knob below and to the left of the control levers prevents creeping.

INDUCTION AIR

Induction air is available from filtered ram air or alternate air. Filtered ram air enters from the intake air scoop on top of the cowling. Should the filter become obstructed, a spring-loaded door on the alternate air intake will open automatically and the induction system will operate on alternate air taken from the engine accessory section.

ENGINE ICE PROTECTION

Engine ice protection consists of electrothermal fuel vent heaters controlled by a switch on the left panel, and an automatic alternate air induction system.

The only significant ice accumulation is impact ice on the inlet scoop and filter. Should the induction air scoop or filter become clogged with ice, a spring-loaded door on the firewall will open automatically, and the induction system will operate on alternate air.

LUBRICATION SYSTEM

The engine oil system for each engine is the full pressure, wet sump type, with a full flow, integrally mounted oil filter and has a 12-quart capacity. Oil operating temperatures are controlled by an automatic thermostat bypass control. The bypass control will limit oil flow through the oil cooler when operating temperatures are below normal and will permit the oil to bypass the cooler if it should become blocked.

The oil system may be checked through access doors in the engine cowling. A calibrated dip stick attached to the filler cap indicates the oil level. Due to the canted position of the engines, the dip sticks are calibrated for either right or left engines and are not interchangeable.

The oil grades listed in the Approved Engine Oils in the SERVICING section are general recommendations only, and will vary with individual circumstances. The determining factor for choosing the correct grade of oil is the average ambient temperature.

COWL FLAPS

The cowl flap for each engine is controlled by a manual control lever located on the lower center console. The cowl flap is closed when the lever is in the up position and open when the lever is down.

PROPELLERS

The engines are equipped with either two or three blade, full feathering, constant speed, propellers. Springs aided by counterweights move the blades to high pitch. Engine oil under governor-boosted pressure moves the blades to low pitch.

The propellers should be cycled occasionally during cold weather operation. This will help maintain warm oil in the propeller hubs so that the oil will not congeal.

HARTZELL AIR-CHARGED PROPELLER DOMES

If propeller air dome pressure is lost during flight, the following symptoms may be noticed: sluggish propeller rpm reduction; overspeed and poor synchronization during higher rpm operation; and propeller overspeed upon the instant opening of the throttle, followed by poor rpm recovery.

NOTE

In the event of pressure loss, feathering capability is lost, but flight can be continued by reducing air speed to regain rpm control. The malfunction should be corrected by an authorized service center before further flight.

PROPELLER SYNCHRONIZER

The propeller synchronizer automatically matches the rpm of both propellers. The system's range of authority is limited to approximately 25 rpm. Normal governor operation is unchanged but the synchronizer will continuously monitor propeller rpm and adjust one governor as required.

A magnetic pickup mounted in each propeller governor transmits electric pulses to a transistorized control box installed behind the pedestal. The control box converts any pulse rate differences into correction commands, which are transmitted to the appropriate governor.

A toggle switch installed on the pedestal turns the system on. To operate the system, synchronize the propellers in the normal manner and turn the synchronizer on. To change

rpm, adjust both propeller controls at the same time. This will keep the setting within the limiting range of the system. If the synchronizer is on but unable to adjust the propeller rpm, the system has reached its range limit. Turn the synchronizer switch off, synchronize the propellers manually, and turn the synchronizer switch on.

PROPELLER SYNCHROSCOPE

A propeller synchroscope, located in the tachometer case, operates to give an indication of synchronization of propellers. If the right propeller is operating at a higher rpm than the left, the face of the synchroscope, a black and white cross pattern, spins in a clockwise rotation. Counterclockwise rotation indicates a higher rpm of the left propeller. This instrument aids the pilot in accomplishing manual synchronization of the propellers.

FUEL SYSTEM

The fuel system is an OFF-ON-CROSSFEED arrangement. The fuel selector panel, located on the floor forward of the front seats, contains the fuel selector for each engine and a schematic diagram of fuel flow.

The standard wing fuel system has a total capacity of 142 gallons. Two optional systems are available. The first has a total capacity of 172 gallons; the second, comprising the 172 gallon system plus wet wing tip tanks, provides a total capacity of 200 gallons. The fuel value placarded adjacent to each filler cap indicates fuel capacity and usable fuel

when that wing fuel system is full. Refer to the LIMITATIONS section for usable fuel in each system.

A vapor return line returns excess fuel from the engine to its respective wing system. All of the fuel cells, standard or optional, in each wing are interconnected in order to make all the usable fuel in each wing available to its engine when the fuel selector valve is turned to ON. The standard 142 gallon and optional 172 gallon fuel systems are filled through a single filler located in each wing. When the wet wing tip option is installed (200 gallons total), there are two additional filler caps, one per wing. Refer to the SERVICING section for additional information.

CAUTION

When the wet wing tip tanks are filled with fuel, DO NOT open the outboard wing leading edge filler caps, as fuel will exit from those openings.

The standard 142 gallon fuel system and the optional 172 gallon fuel system have six drain locations. There are two additional drain locations when the wet wing tip tanks are installed.

Fuel quantity is measured by float type transmitter units which transmit the common level indication to a single indicator for each respective wing system.

When the wet wing tip fuel system is installed, the fuel quantity indicators will read FULL until the fuel quantity remaining is less than 75 gallons. When this occurs, the quantity indicated is coordinated to the total usable fuel supply.

FUEL FLOW AND PRESSURE INDICATOR

Serials TH-773 thru TH-1193

The dual fuel flow indicator on the instrument panel senses fuel pressure at the fuel distributor and is calibrated to indicate fuel flow to each engine in gallons per hour. The green arc indicates the normal fuel flow operating range while the red radials indicate the minimum and maximum allowable fuel pressures.

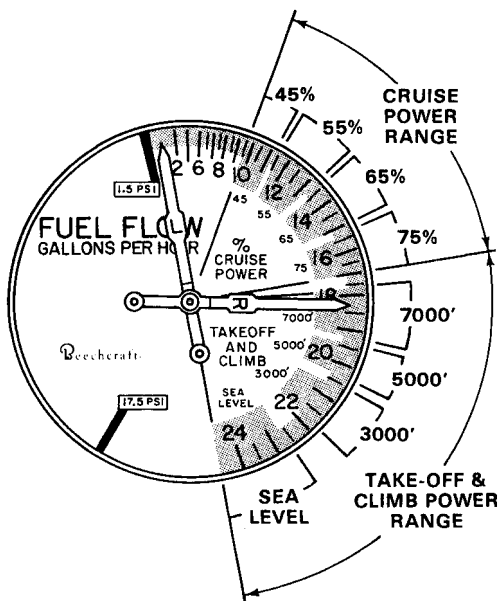

FUEL FLOW AND PRESSURE INDICATOR
(Serials TH-773 thru TH-1193)

The higher end of the green arc includes a sawtooth segment labeled "TAKE-OFF AND CLIMB" and indicates the approximate fuel flow required for takeoff and climb at sea level, 3000, 5000, and 7000 feet. The pilot should use these markings as a guide only and refer to the performance charts for the exact fuel flow requirements for takeoff, climb at maximum continuous power, or climb at maximum normal operating power.

The lower end of the green arc includes a sawtooth segment labeled "% CRUISE POWER" which indicates the approximate fuel flows for powers ranging from 45% to 75% of maximum continuous power. The lower fuel flow of each sawtooth corresponds to the cruise-lean fuel flow while the higher fuel flow of each sawtooth corresponds to the best power fuel flow. When power is set in accordance with the cruise power setting tables in the PERFORMANCE Section, these sawtooth marks provide approximate percent power information.

FUEL FLOW INDICATOR **Serials TH-1194 and after**

The dual fuel flow indicator on the instrument panel is controlled electrically and indicates fuel flow to each engine in gallons per hour. A turbine meter installed in the fuel line rotates in proportion to the fuel flow. The speed of rotation

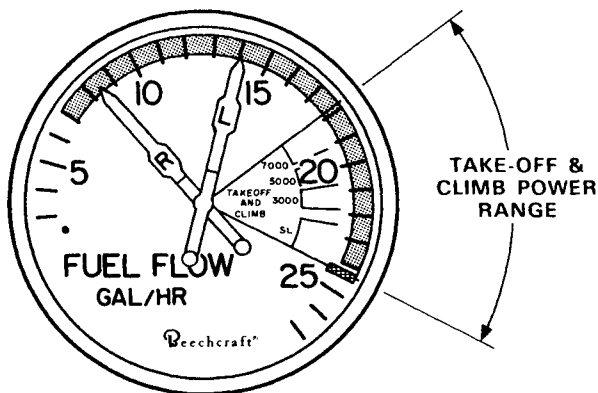

FUEL FLOW INDICATOR
(Serials TH-1194 and after)

is converted to an electrical signal which is then interpreted by the fuel flow indicator. The green arc indicates the normal operating range while the red radial indicates the maximum allowable fuel flow.

A segment of fuel flows at the higher end of the green arc is labeled "TAKEOFF AND CLIMB" and indicates the approximate fuel flow required for takeoff and climb at sea level, 3000, 5000, and 7000 feet. The pilot should use these markings as a guide only and refer to the tables in the PERFORMANCE Section for takeoff, climb at maximum continuous power, or climb at maximum normal operating power.

**Section VII
Systems Description**

**BEECHCRAFT Baron 58
Serial TH 773 and After**

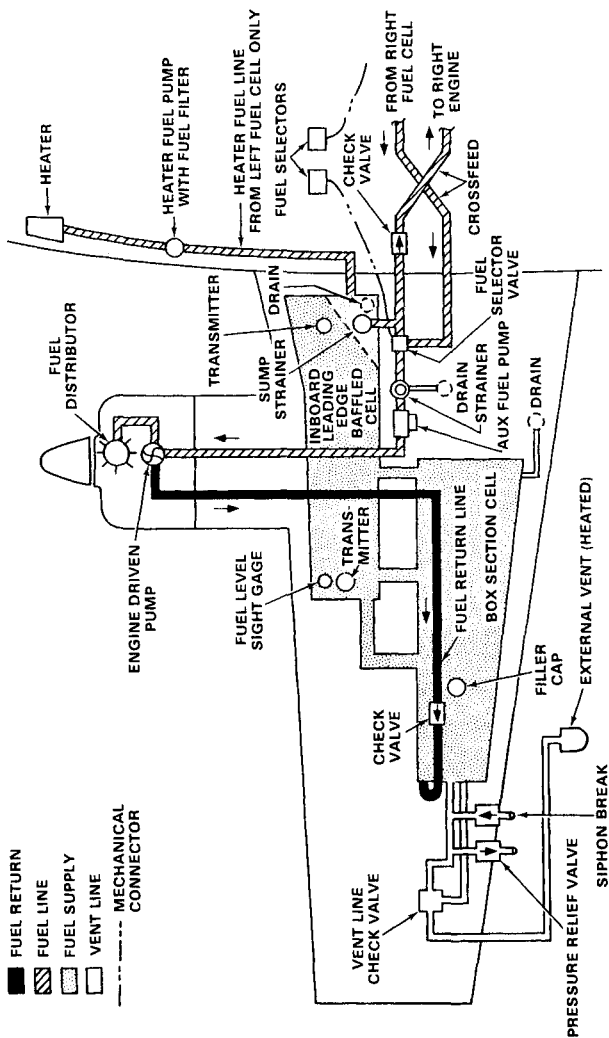

142 GALLON CAPACITY (136 GALLONS USABLE) FUEL SYSTEM

172 GALLON CAPACITY (166 GALLONS USABLE) FUEL SYSTEM

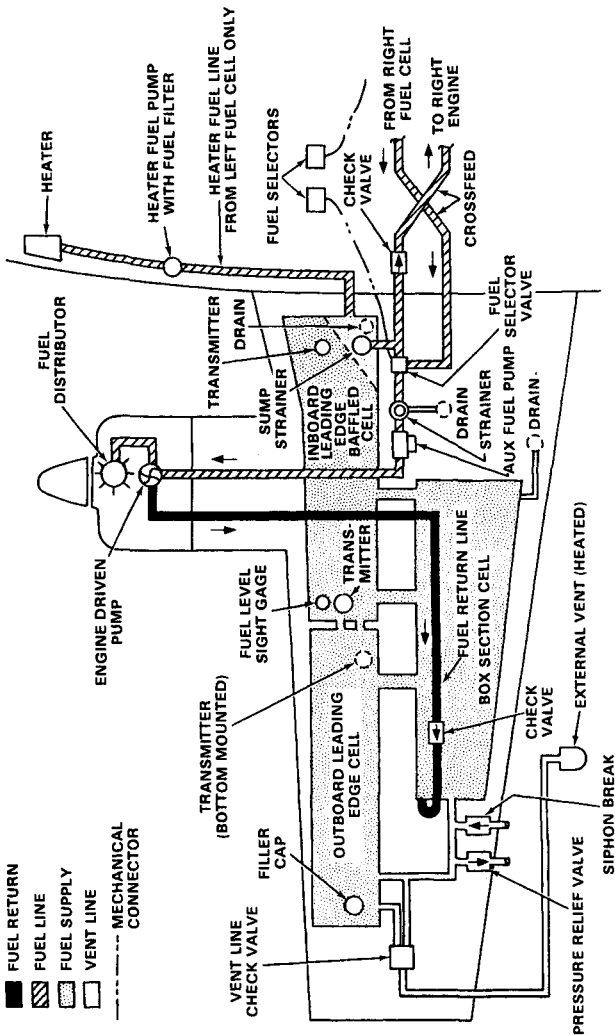

Section VII
Systems Description

BEECHCRAFT Baron 58
Serial TH 773 and After

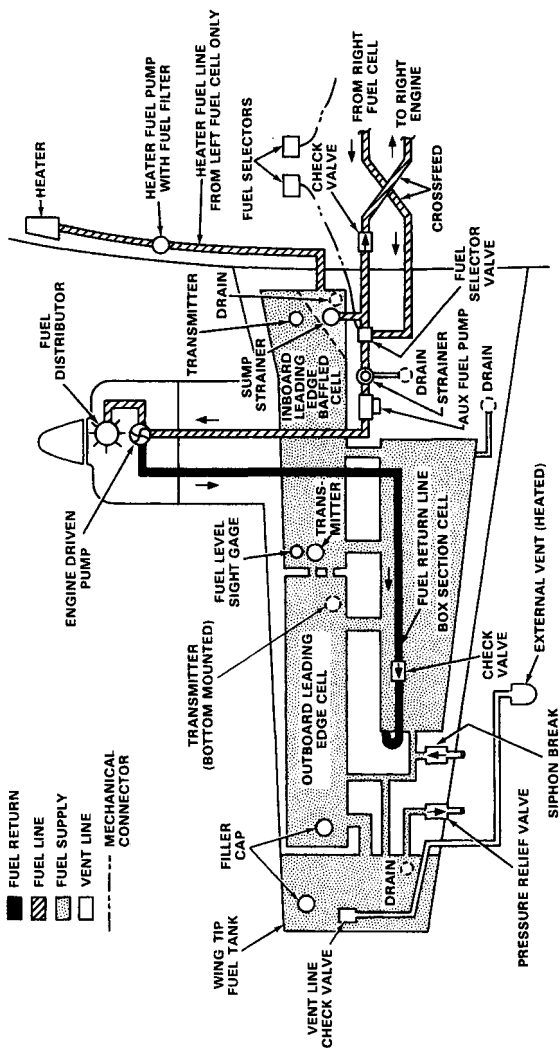

200 GALLON CAPACITY (194 GALLONS USABLE) FUEL SYSTEM

FUEL CROSSFEED (One Engine Inoperative Only)

The fuel lines for the engines are interconnected by cross-feed lines. During normal operation each engine uses its own fuel pumps to draw fuel from its respective wing fuel system. However, on emergency crossfeed operations either engine can consume the available fuel from the opposite side.

The fuel crossfeed system is provided for use during emergency conditions. The system cannot be used to transfer fuel from one wing system to the other. The procedure for using the crossfeed system is described in the EMERGENCY PROCEDURES section.

AUXILIARY FUEL PUMPS

An individual two-speed electric auxiliary fuel pump is provided for each engine. HIGH pressure, OFF or LOW pressure is selected with each auxiliary fuel pump switch on the pilot's subpanel. High pressure is used for providing fuel pressure before starting, and provides near maximum engine performance, should the engine-driven pump fail. Low pressure may be used in any operating mode to eliminate pressure fluctuations resulting from high ambient temperatures and/or high altitudes. The high pressure position should not be selected while the engine is operating except in the event of engine-driven pump failure since the high pressure mode supplies a greater pressure than can be accepted by the injection system during normal operation.

FUEL OFF-LOADING

When installed, a visual fuel level sight gage in each wing leading edge, outboard of the engine nacelle, can be used for partial filling or off-loading of fuel. This gage is to be used only when it reads within the calibrated area.

FUEL REQUIRED FOR FLIGHT

Flight planning and fuel loading is facilitated by the use of fuel quantity indicators that have been coordinated with the

usable fuel supply. It is the pilot's responsibility to ascertain that the fuel quantity indicators are functioning and maintaining a reasonable degree of accuracy, and be certain of ample fuel for a flight. A minimum of 13 gallons of fuel is required in each wing system before takeoff. An inaccurate indicator could give an erroneous indication of fuel quantity. If the pilot is not sure that at least 13 gallons are in each wing system, add necessary fuel so that the amount of fuel will not be less than 13 gallons per wing system at take-off. Plan for an ample margin of fuel for any flight.

ELECTRICAL SYSTEM

In general, the airplane's circuitry is the single-wire, ground return type. The battery, magneto-starter, and alternator switches are located on the left subpanel. This panel contains most of the electrical system switches and switch type circuit breakers. Each is placarded as to its function. The remainder of the electrical equipment circuit breakers are located on the pilot's side panel. Avionics circuit breakers are located on the right subpanel.

BATTERY

One 15.5-ampere-hour, 24-volt lead acid battery is standard. Two 25 ampere-hour, 12-volt lead acid batteries, connected in series, are offered as options. The battery installation is located beneath the floor of the nose baggage compartment. Battery servicing procedures are described in the **SERVICING** section. The battery switch can be turned off in flight and the alternator will remain on the line.

ALTERNATORS (TH-773 thru TH-1376)

Two standard 50- or 60-ampere, or optional 85- or 100-ampere, 28-volt, gear driven alternators are controlled by two transistorized electronic voltage regulators. Only one regulator is operable in the system at any one time. The remaining regulator is used as an alternate or standby unit.

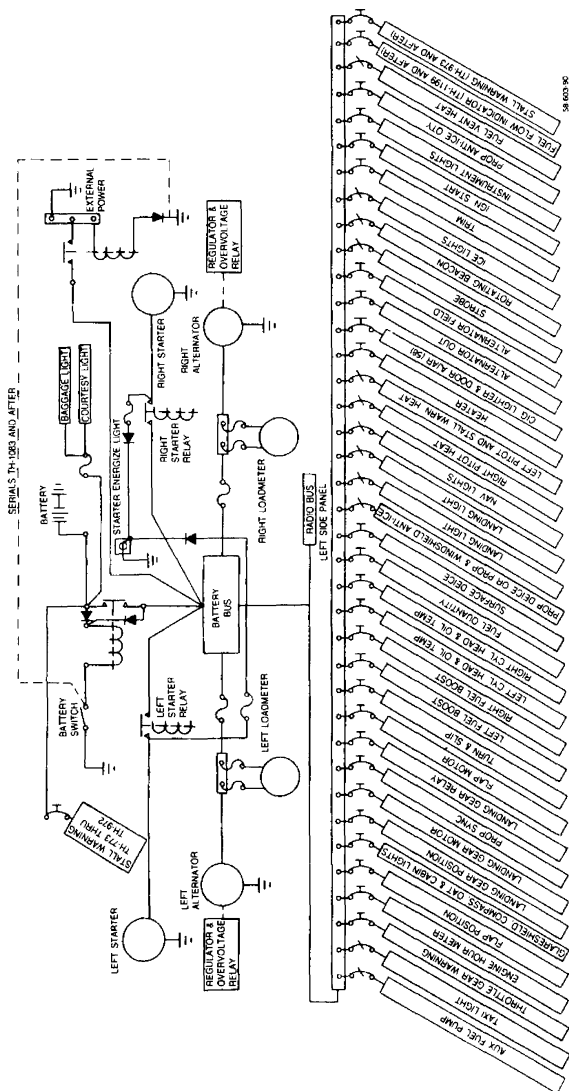

POWER DISTRIBUTION SCHEMATIC

When switched into the circuit, either regulator will adjust alternator output to the required electrical load, including battery recharging. Selection of the regulators is provided by a two-position selector switch on the pilot's subpanel. The alternators are protected by current limiters.

**ALTERNATORS (TH-1377 AND AFTER, AND AIRPLANES
EQUIPPED WITH KIT NO. 55-3024)**

Two standard 60-ampere, or optional 100-ampere, 28-volt, gear-driven alternators are individually controlled by alternator control units which, regulate the voltage, balance the load and provide overvoltage protection. Each alternator system is controlled by a switch located on the subpanel.

(TH-773 AND AFTER)

Individual alternator output is indicated by two loadmeters on the instrument panel. The loadmeters give a percentage reading of the load on the system.

Two warning lights, placarded ALTERNATOR-L-R, located in the floating instrument panel, will illuminate whenever the respective alternator is disconnected from the bus by low voltage or an over-voltage condition or with the switch in the OFF position. On serials TH-1194 and after, the lights will illuminate if the fuse on the AUX terminal of the alternator is blown. Any time a failure is detected, the appropriate alternator should be turned OFF. The ALTERNATOR-L-R lights are tested by the TEST-BRT-DIM-WARN LIGHTS switch, located on the pilot's floating instrument panel.

STARTERS

The starters are relay-controlled and are actuated by rotary type, momentary-on switches incorporated in the magneto/start switches located on the pilot's subpanel. To energize the starter circuit, hold the magneto/start switch in the START position. After starting, release the switch to the BOTH position.

The warning light placarded STARTER ENERGIZED (serials TH-1194 and after) will illuminate whenever electrical power is being supplied to either the left or right starter. If the light remains illuminated after starting, the starter relay has remained engaged and loss of electrical power may result. The battery master and both alternator switches should be placed in the OFF position if the light remains illuminated after starting. If the light does not illuminate during starting, the indicator system is inoperative and the loadmeters should be monitored to ensure that the starters do not remain energized after starting. This light can be tested by the TEST-WARN LIGHT switch, located on the floating instrument panel.

EXTERNAL POWER

The external power receptacle is located in the outboard side of the left nacelle and accepts a standard AN type plug. The power unit should be capable of delivering at least 300 amperes for starting. Before connecting an external power unit, turn the electrical systems and avionics off to avoid damage due to electrical surges. When external power is connected, the battery switch should be turned on. If polarity is reversed, a diode in the coil circuit will prevent contactor operation.

LIGHTING SYSTEM

INTERIOR LIGHTING

The courtesy light, located in the forward cabin door, will illuminate any time the cabin door is open. On airplanes TH-1298 and after, the courtesy light is connected to a timer which will extinguish the light approximately 15 minutes after the door is opened.

The cabin dome light is operated by an ON-OFF switch located just forward of the light.

Individual reading lights located above the standard third and fourth or optional fifth and sixth seats are operated by switches adjacent to the lights.

There are four rheostat dimmer control knobs located on the lower level of the circuit breaker panel: the individual instrument lights located above the pilot's subpanel are controlled by the knob placarded INCREASE - OFF - SUBPANEL LIGHTING; the avionics panel and trim tab indicator lights are controlled by the knob placarded INCREASE - OFF - INST FLOOD; the instrument lights in the glareshield are controlled by the knob placarded INCREASE - OFF - FLIGHT INST; and the electroluminescent lighting in the pilot's subpanel is controlled by the knob placarded INCREASE - OFF - ENG INST AVIONICS CONSOLE.

The magnetic compass light, outside air temperature indicator light, and map light are operated by a switch on the pilot's control wheel.

The light located in the nose baggage/cargo compartment automatically illuminates when the compartment door is opened. A manual switch located in the compartment may be used to manually extinguish the light.

EXTERIOR LIGHTING

The switches for the navigation lights, landing light(s), rotating beacons, nose gear taxi light (if installed), and wing ice light(s) are at the top of the pilot's subpanel. The two wing leading edge landing lights are operated by separate switches. With optional wing tip fuel tanks (TH-773 thru TH-873), a single nose gear landing light replaces the two leading edge landing lights and the optional nose gear taxi light. With optional wing tip fuel tanks (TH-874 and after), the landing lights are located on the front lower section of each engine cowling. For longer battery and lamp service life, use the landing light(s) only when necessary. Avoid prolonged operation, during ground maneuvering, which could cause overheating. The optional taxi light (if installed) is offered for use during ground operations. At night, reflections from rotating anti-collision lights on clouds, dense haze, or dust can produce optical illusions and vertigo. The use of these lights is not advisable under instrument or limited VFR conditions.

INTENTIONALLY LEFT BLANK

HEATING AND VENTILATION SYSTEM

CABIN HEATING

A combustion heater in the nose cone supplies heated air to the cabin. Outlets are located forward of the pilot and copilot seats, at the rear of the copilot's seat, and at the

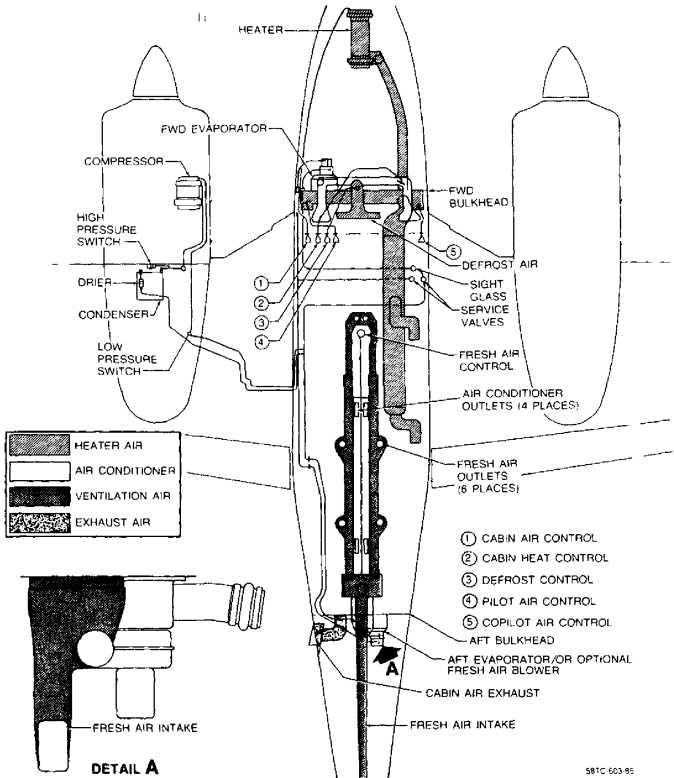

581C 603 95

ENVIRONMENTAL SCHEMATIC

rear of the right passenger seat. The fifth outlet provides heated air for windshield defrosting.

In flight, fresh ram air enters an intake on each side of the nose cone, passes through the heater, and is distributed to the cabin outlets. For ground operation, a blower maintains airflow through the system.

If a malfunction resulting in dangerously high temperatures should occur, a heat actuated circuit breaker, located on the heater, will render the heater system, except the blower, inoperative. MAKE CERTAIN ANY MALFUNCTION CAUSING THE OVERHEAT CIRCUIT BREAKER TO POP IS CORRECTED BEFORE ATTEMPTING TO OPERATE THE HEATER AGAIN.

HEATER OPERATION

1. A three-position switch, placarded BLOWER, OFF, and HEATER, is located on the pilot's subpanel. To place the heating system in operation, move the switch to the HEATER position.
2. The CABIN AIR T-handle, which regulates the amount of intake air, is below the left side of the pilot's subpanel. On TH-873, TH-895 and after, it is below the circuit breaker panel on the left sidewall. Push the CABIN AIR control full forward to the full open position.
3. Pull out the CABIN HEAT control located below the left side of the pilot's subpanel, to raise the temperature of the heated air. Push the CABIN HEAT control in to decrease temperature.
4. For windshield defrosting, push in the DEFROST control located to the right of the CABIN HEAT control.
5. To direct heated air onto the pilot's feet, pull out the PILOT AIR control to the right of the DEFROST control.

6. The COPILOT AIR control, identical to the PILOT AIR control, is located below the right side of the instrument panel.

HEAT REGULATION

For maximum heat, the CABIN AIR control can be pulled aft to reduce the volume of incoming cold air and permit the heater to raise the temperature of the admitted air. However, if the CABIN AIR control is pulled aft more than halfway, the heater will not operate.

The volume of air available for the pilot outlet and the copilot outlet can be divided between the two outlets as desired by adjusting each control individually.

More heated air will be available for defrosting by reducing the flow of air from the pilot outlet, copilot outlet, or both.

The PILOT AIR and COPILOT AIR controls can be used to regulate the volume of air distributed to the rear outlets.

HEATER BLOWER

When the three-position switch on the pilot's subpanel is placed in either the HEATER position or the BLOWER position, the blower will operate if the landing gear is in the extended position and the CABIN AIR control is more than halfway in. The blower will automatically shut off if the landing gear is retracted or the CABIN AIR control is pulled out approximately halfway.

CABIN VENTILATION

In flight, to provide unheated air for the same cabin outlets used for heating, push the CABIN AIR and CABIN HEAT controls forward.

Section VII Systems Description

BEECHCRAFT Baron 58 Serial TH 773 and After

For ventilation during ground operation, push the CABIN AIR control forward and place the three-position switch on the pilot's subpanel in the BLOWER position. An optional fresh air blower (Serials TH-1225 and after) located in the aft fuselage provides additional ventilation through the overhead outlets during ground operations, and automatically shuts off in flight.

INDIVIDUAL FRESH AIR OUTLETS

Fresh ram air from the intake on the left side of the dorsal fairing is ducted to individual outlets above each seat, including the optional fifth and sixth seats. A master control in the overhead panel just aft of the front air outlets enables the pilot to adjust the amount of ram air available to all outlets. The volume of air at each outlet can be regulated by rotating the outlet. Each outlet can be positioned to direct the flow of air as desired.

OXYGEN SYSTEM

WARNING

Proper safety measures must be employed when using oxygen, or a serious fire hazard will be created. **NO SMOKING PERMITTED.**

DESCRIPTION

The recommended masks are provided with the system. The masks are designed to be adjustable to fit the average person.

The oxygen cylinder is located at the aft end of the forward baggage compartment. The system is available with either four, five, or six outlets and with a 49.8 or 66 cu ft oxygen bottle. Supply of oxygen to the system is controlled by a push-pull control on the pilot's subpanel. The pressure indicator shows the supply of oxygen available (1850 psi is nominal pressure for a full supply in the cylinder).

The system regulator is altitude compensated to provide a varying flow of oxygen with altitude. Flow is varied automatically from 0.5 liters per minute at 5,000 feet to 3.5 liters per minute at 30,000 feet. The use of oxygen is recommended to be in accordance with current FAR operating rules.

PITOT AND STATIC SYSTEM

The pitot and static system provides a source of impact and static air for the operation of flight instruments.

PITOT SYSTEM

A standard pitot tube for the pilot's flight instruments is located immediately to the left of the nose gear doors. The optional pitot tube for the copilot's instrument is located to the right of the nose gear doors.

Left and right pitot heat switches, located on the pilot's left subpanel, supply heat to the left and right pitot masts respectively.

The pitot system needs no drain because of the location of the components.

STATIC SYSTEM

Static air is taken from a flush static port located on each side of the aft fuselage. The static air is routed to the rate-of-climb indicator, altimeter and airspeed indicator.

The static air line is drained at the emergency static air source by raising the lever to the emergency static air source position. Return the lever to normal position after the line is completely drained.

The emergency static air source is designed to provide a source of static pressure to the instruments from inside the fuselage should the outside static air ports become blocked. An abnormal reading of the instruments supplied with static air could indicate a restriction in the outside static air ports. A lever on the lower sidewall adjacent to the pilot, is placarded OFF NORMAL, ON EMERGENCY. When it is desired or required to use this alternate source of static air, select the ON EMERGENCY position. To recognize the need and procedures for the use of emergency static air, refer to EMERGENCY PROCEDURES. Airspeed Calibrations and Altimeter Corrections charts are in the PERFORMANCE section.

PRESSURE SYSTEM

Pressure for the flight instruments, deice boots, and autopilot (if installed) is supplied by two, engine-driven, dry, pressure pumps interconnected to form a single system. If either pump fails, check valves automatically close and the remaining pump continues to operate all gyro instruments. A pressure gage on the instrument panel indicates pressure in inches of mercury. Two red buttons on the pressure gage serve as source failure indicators, each for its respective side of the system. The pressure system incorporates two filters per engine. One is located on the rear baffle of the engine to filter intake air to the pressure pump. The other is down stream of the pump and is located aft of the firewall in the upper nacelle. This filter protects the instruments.

STALL WARNING

A stall warning horn on the cabin forward bulkhead sounds a warning signal while there is time for the pilot to correct the attitude. The horn is triggered by a sensing vane on the leading edge of the left wing and is effective in all flight attitudes and at all weights and airspeeds. Irregular and intermittent at first, the warning signal will become steady as the airplane approaches a complete stall.

Electrical power is supplied to the stall warning horn directly from the battery (TH-733 through TH-972) or from the main electrical bus (TH-973 and after).

WARNING

The stall warning horn (TH-973 and after) is inoperative when the battery and alternator switches are OFF while in flight.

In icing conditions, stalling airspeeds should be expected to increase due to the distortion of the wing airfoil when ice has accumulated on the airplane. For the same reason, stall warning devices tend to lose their accuracy. The sensing vane is installed on a plate that can be electrically heated, preventing ice from forming on the vane of the transducer. A switch on the pilot's subpanel, placarded PITOT HEAT, supplies power to the heated pitot mast and to the heating plate at the stall warning transducer. However, any accumulation of ice in the proximity of the stall warning vane reduces the probability of accuracy in the stall warning system whether or not the vane itself is clear of ice. For this reason, it is advisable to maintain an extra margin of airspeed above the stall speed.

ICE PROTECTION SYSTEMS

SURFACE DEICE SYSTEM

Deice boots bonded to the leading edges of the wings and the tail surfaces are operated by engine-driven pump pressure. Compressed air, after passing through the pressure regulator, goes to the distributor valve. When the deice system is not in operation, the distributor valve applies vacuum to the boots to deflate and hold the boots flat against the surface. Then, when the deice system is operated, the distributor valve changes from vacuum to pressure and the boots inflate. After the cycle is completed, the valve returns to vacuum hold down.

A three-position, spring loaded switch, with a center OFF position, a MAN (manual) down position, and an up AUTO (automatic) position, controls the system. When the switch is in the AUTO position, the deice boots inflate for a period of five to six seconds, then deflate automatically and return to the vacuum hold down position. The switch must be tripped for each complete cycle. In the MAN position the deice boots inflate as long as the switch is held in this position. When the switch is released, the boots deflate and go to the vacuum hold down condition.

Deice boots are designed to remove ice after it has accumulated, rather than prevent its formation. If the rate of ice accumulation is slow, best results are obtained by leaving the deice system off until 1/2 to 1 inch of ice accumulates. Bridging can occur if boots are actuated too early or too frequently.

The wing ice light(s), used to check for ice accumulation during night operation, illuminates the wing leading edge. The light switch is on the pilot's subpanel.

WINDSHIELD ANTI-ICE (ELECTROTHERMAL)

The pilot's electrically heated windshield segment is controlled by a switch located on the left subpanel. Windshield heat is designed for continuous in-flight use and should be applied prior to, or upon first encountering, icing conditions. This system is also beneficial as an aid in preventing frost and fogging due to rapid descents from higher altitudes into warm, moist air.

Operation of the windshield heat will cause the standby compass to become erratic; therefore, windshield heat should be turned off for a period of 15 seconds to allow a stable reading of the standby compass.

CAUTION

Ground use of windshield heat is limited to 10 minutes.

INTENTIONALLY LEFT BLANK

PROPELLER AND WINDSHIELD ANTI-ICE SYSTEM (FLUID FLOW)

The system is designed to prevent the formation of ice. Always place the system in operation before encountering icing conditions.

Ice is prevented from forming on the propeller blades by wetting the blade anti-ice boots with anti-icing fluid. The anti-ice pump delivers a constant flow of fluid from the supply tank to the blade boots. The pump is controlled by an ON-OFF switch located on the pilot's subpanel.

Windshield anti-ice (when installed) receives anti-ice fluid from the same source as the propeller anti-ice system. Ice is prevented from forming on the windshield by wetting the windshield surface with anti-ice fluid. This combined system is controlled by a three position switch, MOM ON-OFF-ON, located on the pilot's subpanel. The system will not function unless the propeller anti-ice pump switch is turned ON. For windshield system only, the flow is controlled by an ON-OFF switch. An indicator on the right side of the instrument panel indicates the amount of fluid in the supply tank.

With a full reservoir, system endurance is:

Left Windshield Only	approx. 36 min.
Left & Right Windshield	approx. 18 min.
Prop Anti-ice Only	approx. 120 min.
Prop & Left Windshield	approx. 28 min.
Prop, Left & Right Windshield	approx. 16 min.

ELECTROTHERMAL PROPELLER DEICE (2 and 3 BLADES)

Propeller ice removal is accomplished by the electrically heated deice boots bonded to each propeller blade. The system uses the aircraft electrical power to heat portions of the deice boots in a sequence controlled by a timer. The system is controlled by an ON-OFF switch on the pilot's subpanel. When the system is turned on the ammeter will register 7 to 12 amperes on the 2 blade propeller, or 14 to 18 amperes on the 3 blade propeller. The system can be operated continuously in flight; it will function automatically until the switch is turned off. Propeller imbalance can be relieved by varying rpm. Increase rpm briefly, then return to the desired setting. Repeat if necessary.

CAUTION

Do not operate the system with the engines inoperative.

PITOT HEAT

Heating elements are installed in the pitot mast(s). Each heating element is controlled by an individual switch located on the pilot's subpanel. The switches are placarded PITOT HEAT - LT - RT, and should remain off during ground operations, except for testing or for short intervals of time to remove ice or snow from the mast(s).

STALL WARNING ANTI-ICE

The mounting pad and the stall warning vane are equipped with a heating element that is activated any time the switch placarded PITOT HEAT - LT, is on.

HEATED FUEL VENTS

The fuel system vents, one located on the underside of each wing outboard of the nacelle, are provided with heating elements controlled by the FUEL VENT switch on the pilot's subpanel.

ENGINE BREAK-IN INFORMATION

MIL-C-6529 Type II Multiviscosity 20W-50 Corrosion-Preventative Oil is installed in the engine at the factory. It is recommended that this oil be *removed and the oil filter changed at 20 hours* of engine operation or no later than 25 hours. If oil consumption has not stabilized by this time, the engine should be drained and refilled with MIL-L-6082 Mineral Oil. This oil should be used until oil consumption stabilizes; usually a total of approximately 50 hours. After oil consumption has stabilized, MIL-L-22851 Ashless Dispersant Oil should be used.

Drain and replace the engine oil as recommended in **HANDLING, SERVICING AND MAINTENANCE**. If operating conditions are unusually dusty or dirty, more frequent oil changes may be necessary. Oil changes are more critical during the break-in period than at any other time.

Use full throttle at recommended rpm for every takeoff and maintain until at least 400 feet AGL, then reduce as necessary for cruise climb or cruise. Maintain the highest power recommended for cruise operations during the break-in period, avoiding altitudes above 8000 feet. Interrupt cruise power every 30 minutes or so by smoothly advancing to take-off power settings for about 30 seconds, then returning to cruise power settings.

Avoid long power-off descents especially during the break-in period. Maintain sufficient power during descent to permit cylinder head temperatures to remain in the green arc.

Minimize ground operation time, especially during warm weather. During the break-in period, avoid engine idling in excess of 15 minutes, especially in high ambient temperatures.

SECTION VIII

HANDLING, SERVICING AND MAINTENANCE

TABLE OF CONTENTS

<i>SUBJECT</i>	<i>PAGE</i>
Introduction.....	8-5
Publications	8-6
Airplane Inspection Periods.....	8-6A
Preventative Maintenance That May Be	
Accomplished By A Certificated Pilot.....	8-6A
Alterations or Repairs to Airplane.....	8-6B
Ground Handling.....	8-8
Towing	8-8
Parking.....	8-8
Tie-Down.....	8-9
Main Wheel Jacking	8-10
Prolonged Out of Service Care	8-10
Storage	8-10
Flyable Storage - 7 to 30 Days.....	8-10
Mooring	8-10
Engine Preparation For Storage	8-11
During Flyable Storage	8-11
Fuel Cells.....	8-11
Flight Control Surfaces	8-11
Grounding.....	8-11
Engines/Pitot Tube	8-12
Windshield and Windows.....	8-12
Preparation For Service	8-12

TABLE OF CONTENTS (Continued)

<i>SUBJECT</i>	<i>PAGE</i>
External Power	8-12
Recharging the Battery (Using Auxiliary Power).....	8-13
Checking Electrical Equipment.....	8-13
Servicing.....	8-13
Fuel System	8-13
Fuel Cells.....	8-13
Fuel Drains	8-15
Fuel Strainers	8-15
Oil System.....	8-16
Battery.....	8-17
Tires	8-17
Shock Struts.....	8-18
Shock Strut Shimmy Damper	8-19
Brakes.....	8-20
Induction Air Filter	8-20
To Remove and Clean the Filter	8-20
Propellers.....	8-20
Propeller Blade Bearing Lubrication	8-21
Propeller and Windshield Anti-ice Tank (Fluid)	8-21
Oxygen System.....	8-22
Oxygen Cylinder Retesting	8-23
Minor Maintenance	8-23
Rubber Seals	8-23
Heating and Ventilating System	8-23
Alternators.....	8-24
Magnetos	8-24
Cleaning	8-25
Exterior Painted Surfaces.....	8-25
Windshield and Windows	8-26B
Surface Deice Boots.....	8-26B
Engine.....	8-27

TABLE OF CONTENTS (Continued)

<i>SUBJECT</i>	<i>PAGE</i>
Interior.....	8-27
Lubrication Points.....	8-28
Recommended Servicing Schedule.....	8-35
Consumable Materials.....	8-41
Approved Engine Oils.....	8-43
Bulb Replacement Guide.....	8-45
Overhaul or Replacement Schedule.....	8-46
Special Conditions Cautionary Notice.....	8-46
Landing Gear.....	8-47
Power Plant.....	8-47
Fuel System.....	8-48
Instruments.....	8-49
Electrical System.....	8-49
Utility Systems.....	8-50
Flaps and Flight Controls.....	8-50
Miscellaneous.....	8-51

INTENTIONALLY LEFT BLANK

INTRODUCTION

The purpose of this section is to outline the requirements for maintaining the airplane in a condition equal to that of its original manufacture. This information sets the time frequency intervals at which the airplane should be taken to a BEECHCRAFT Aero or Aviation Center or International Distributor or Dealer for periodic servicing or preventive maintenance.

The Federal Aviation Regulations place the responsibility for the maintenance of this airplane on the owner and operator of the airplane who must ensure that all maintenance is done by qualified mechanics in conformity with all airworthiness requirements established for this airplane.

All limits, procedures, safety practices, time limits, servicing and maintenance requirements contained in this handbook are considered mandatory.

Authorized BEECHCRAFT Aero or Aviation Centers or International Distributors or Dealers can provide recommended modification, service, and operating procedures issued by both the FAA and Beech Aircraft Corporation, which are designed to get maximum utility and safety from the airplane.

If there is a question concerning the care of the airplane, it is important to include the airplane serial number in any correspondence. The serial number appears on the model designation placard attached to the right side of the fuselage at the inboard end of the flap.

PUBLICATIONS

The following publications are available through BEECHCRAFT Aero or Aviation Centers or International Distributors or Dealers:

1. Shop Manual
2. Parts Catalog
3. Service Instructions
4. Various Inspection Forms
5. Wiring Diagram Manual

NOTICE

The following information may be provided to the holder of this manual automatically:

1. Original issues and revisions of BEECHCRAFT Service Bulletins
2. Original issues and revisions of FAA Approved Airplane Flight Manual Supplements
3. Reissues and revisions of FAA Approved Airplane Flight Manuals, Flight Handbooks, Owner's Manuals, Pilot's Operating Manuals, and Pilot's Operating Handbooks

This service is free and will be provided only to holders of this handbook who are listed on the FAA Aircraft Registration Branch List or the BEECHCRAFT International Owners Notification Service List, and then only if listed by airplane

serial number for the model for which this handbook is applicable. For detailed information on how to obtain "Revision Service" applicable to this handbook or other BEECHCRAFT Service Publications, consult a BEECHCRAFT Aero or Aviation Center, International Distributor or Dealer, or refer to the latest revision of BEECHCRAFT Service Bulletin No. 2001.

AIRPLANE INSPECTION PERIODS

1. FAA-required 100-hour and/or Annual Inspections.
2. BEECHCRAFT Approved Inspection Guide.
3. Continuing Care Inspection Guide.
4. See "Recommended Servicing Schedule" and "Overhaul or Replacement Schedule" for further inspection schedules.

NOTE

Check the wing bolts for proper torque at the first 100-hour inspection and at the first 100-hour inspection after each reinstallation of the wing attach bolts.

PREVENTATIVE MAINTENANCE THAT MAY BE ACCOMPLISHED BY A CERTIFICATED PILOT

1. A certificated pilot may perform limited maintenance. Refer to FAR Part 43 for the items which may be accomplished.

To ensure proper procedures are followed, obtain a BEEHCRAFT Shop Manual for performing preventative maintenance.

2. All other maintenance must be performed by licensed personnel.

NOTE

Pilots operating airplanes of other than U. S. registry should refer to the regulations of the country of certification for information on preventative maintenance that may be performed by pilots.

ALTERATIONS OR REPAIRS TO AIRPLANE

The FAA should be contacted prior to any alterations on the airplane to ensure the airworthiness of the airplane is not violated.

NOTE

Alterations or repairs to the airplane must be accomplished by licensed personnel.

WARNING

Use only genuine BEEHCRAFT or BEEHCRAFT approved parts obtained from BEEHCRAFT approved sources, in connection with the maintenance and repair of Beech airplanes.

Genuine BEEHCRAFT parts are produced and inspected under rigorous procedures to ensure airworthiness and suitability for use in Beech airplane applications. Parts purchased from sources other than BEEHCRAFT, even though outwardly identical in appearance, may not have had the required tests and inspections performed, may be different in fabrication techniques and materials, and may be dangerous when installed in an airplane.

Salvaged airplane parts, reworked parts obtained from non-BEEHCRAFT approved sources, or parts, components, or structural assemblies, the service history of which is unknown or cannot be authenticated, may have been subjected to unacceptable stresses or temperatures or have other hidden damage, not discernible through routine visual or usual nondestructive testing techniques. This may render the part, component or structural assembly, even though originally manufactured by BEEHCRAFT, unsuitable and unsafe for airplane use.

BEEHCRAFT expressly disclaims any responsibility for malfunctions, failures, damage or injury caused by use of non-BEEHCRAFT approved parts.

GROUND HANDLING

The three-view drawing in Section 1 shows the minimum hangar clearances for a standard airplane. Allowances must be made for any special radio antennas.

CAUTION

To insure adequate propeller clearance, always observe recommended shock strut servicing procedures and tire inflation pressures.

TOWING

Attach the tow bar to the tow pin on the nose gear lower torque knee. It is recommended to have someone in the airplane to operate the brakes.

CAUTION

Do not exert force on the propellers, control surfaces, or horizontal stabilizer. When towing with a tug, limit turns to prevent damage to the nose gear. Do not tow when the main gear is obstructed by mud or snow. Also ensure the rudder lock is removed.

Care should be used when removing the tow bar to prevent damage to the lubrication fittings on the landing gear.

PARKING

The parking brake T-handle control is located just left of the elevator tab wheel on the pilot's subpanel. To set the parking brakes, pull control out and depress each toe pedal until firm. Push the control in to release the brakes.

NOTE

Excessive pedal pressure may prevent releasing of the parking brake.

On Serials TH-773 thru TH-1005 with shuttle valves installed, only the pilot's brake pedals can be used in conjunction with the parking brake system to set the parking brake.

The parking brake should be left off and wheel chocks installed if the airplane is to be left unattended. Changes in ambient temperature can cause the brakes to release or to exert excessive pressures.

TIE-DOWN

It is advisable to nose the airplane into the wind. Three tie-down lugs are provided: one on the lower side of each wing and a third at the rear of the fuselage.

1. Install the control locks.
2. Chock the main wheels, fore and aft.
3. Using nylon line or chain of sufficient strength, secure the airplane at the three points provided. **DO NOT OVER TIGHTEN**; if the line at the rear of the fuselage is excessively tight, the nose may rise and produce lift due to the angle of attack of the wings.
4. Release the parking brake.

If high winds are anticipated, a vertical tail post should be installed at the rear tie-down lug, and a tie-down line attached to the nose gear.

MAIN WHEEL JACKING

1. Check the shock strut for proper inflation to prevent damage to the landing gear door by the jack adapter and to facilitate installation of the adapter.
2. Insert the main wheel jack adapter into the main wheel axle.
3. A scissors-type jack is recommended for raising and lowering the wheel.
4. When lowering the wheel, exercise care to prevent compression of the shock strut, which would force the landing gear door against the jack adapter.

NOTE

Persons should not be in or on the airplane while it is on a main wheel jack.

PROLONGED OUT OF SERVICE CARE

STORAGE

Storage procedures are intended to protect the airplane from deterioration while it is not in use. The primary objectives of these measures are to prevent corrosion and damage from exposure to the elements.

Flyable Storage (7-30 days) has been considered here. For more extended storage periods, consult the Beech Airplane Shop Manual and Continental Service Bulletin M 74-9 or later issue.

FLYABLE STORAGE - 7 TO 30 DAYS

MOORING

If airplane cannot be placed in a hangar, tie down securely at the three points provided. Do not use hemp or manila rope. It is recommended a tail support be used to compress the nose strut and reduce the angle of attack of the wings. Attach a line to the nose gear.

ENGINE PREPARATION FOR STORAGE

Engines in airplanes that are flown only occasionally tend to exhibit cylinder wall corrosion much more than engines that are flown frequently.

Run engine at least five minutes at 1200 to 1500 rpm with oil and cylinder head temperatures in the normal operating range.

Check for correct oil level and add oil if necessary to bring level to full mark.

DURING FLYABLE STORAGE

Each seven days during flyable storage, the propellers shall be rotated by hand. After rotating each engine six revolutions, stop the propellers 60° or 120° from the position they were in.

WARNING

Before rotation of propeller blades, ascertain magneto/start switches are OFF, throttles are in the CLOSED position, and mixture controls are in the IDLE CUT-OFF position. Always stand in the clear while turning propellers.

If at the end of 30 days, airplane will not be removed from storage, the engine shall be started and run. The preferred method will be to fly the airplane for 30 minutes, and up to, but not exceeding normal oil and cylinder temperatures.

FUEL CELLS

Fill to capacity to minimize fuel vapor and protect cell inner liners.

FLIGHT CONTROL SURFACES

Lock with internal and external locks.

GROUNDING

Static ground airplane securely and effectively.

ENGINES / PITOT TUBE(S)

Install cover(s).

WINDSHIELD AND WINDOWS

Close all windows and window vents. It is recommended that covers be installed over windshield and windows.

PREPARATION FOR SERVICE

Remove all covers, clean the airplane, and give it a thorough inspection, particularly landing gear, wheel wells, flaps, control surfaces, and pitot and static pressure openings.

Preflight the airplane.

EXTERNAL POWER

When using external power, it is very important that the following precautions be observed:

1. The airplane has a negative ground system. Exercise care to avoid reversed polarity. Be sure to connect the positive lead of the auxiliary power unit to the positive terminal of the airplane's external power receptacle and the negative lead to the negative terminal of the external power receptacle. A positive voltage must also be applied to the small guide pin.
2. To prevent arcing, make certain no power is being supplied when the connection is made.

3. Make certain that the battery switch is ON, all avionics and electrical switches OFF, and a battery is in the system before connecting an external power unit. This protects the electronic voltage regulators and associated electrical equipment from voltage transients (power fluctuations).

CHECKING ELECTRICAL EQUIPMENT

Connect an auxiliary power unit as outlined in Starting Procedures. Ensure that the current is stabilized prior to making any electrical equipment or avionics check.

NOTE

If the external power unit has poor voltage regulation or produces voltage transients, the aircraft electrical equipment connected to the unit may be damaged.

SERVICING

FUEL SYSTEM

FUEL CELLS

See Consumable Materials for recommended fuel grades.

The standard 142 gallon capacity fuel system has a fuel filler cap in each wing box section. The optional 172 gallon capacity system has a filler cap in each outboard wing leading edge. The optional 200 gallon capacity system has a filler cap in each wet wing tip and in each outboard wing leading edge.

NOTE

To obtain the maximum capacity of the fuel system when the wet wing tips are installed, fill the fuel system from the wet wing tip tank filler caps to the bottom of the tab marked FULL.

Refer to the LIMITATIONS section for the usable fuel in each system.

CAUTION

Caution must be taken when the wet wing tip tanks are filled with fuel. DO NOT open the out-board wing leading edge filler cap, as fuel will exit from that opening. If this occurs, wash the fuel from the wing surface to prevent possible paint damage.

Ground the aircraft with a static line before refueling and secure the filler caps immediately after filling. Before letting the airplane stand for several days, it is a good practice to fill the wing fuel system to ensure that the cell inner liners do not dry out and crack, allowing fuel to diffuse through the cell walls. Also, less moisture condensation will occur when fuel cells are full. If the cells are to be drained before storage, a coating of light engine oil should be sprayed or flushed onto the inner liners of the cells as a preservative.

NOTE -

The optional 200 gallon fuel system should be filled from the wing leading edge filler cap when airplane must stand for several days. Check and fill to capacity at wet wing tip filler cap before flight if required for the mission.

FUEL DRAINS

Open each of the snap-type or flush-type fuel drains daily to purge any water from the system. The two sump drains extend through the bottom of each wing. The fuel strainer in each wheel well is provided with a drain extending through the wheel well skin. Two additional flush-type fuel drains are located at the midpoint, inboard lower surface of the wet wing tip fuel tanks (if installed). When the flush type drains are installed, a drain wrench is provided in the loose tools and accessories.

FUEL STRAINERS

To preclude the possibility of contaminated fuel, always cap any disconnected fuel lines or fittings. The fuel strainer in each wheel well should be inspected and cleaned with solvent at regular intervals. The frequency of inspection and cleaning will depend upon service conditions, fuel handling cleanliness, and local sand and dust conditions. At each 100-hour inspection the strainer plug should be removed from the fuel injection control valve and the fuel injection control valve screen washed in fresh cleaning solvent. After the strainer plug has been reinstalled and safetied, the installation should be checked for leakage. A leading edge sump strainer, accessible through an access door on the bottom of the wing, should be cleaned periodically.

OIL SYSTEM

The engines are equipped with a wet sump, pressure type oil system. Each engine sump has a capacity of 12 quarts. The oil system may be checked through access doors in the engine cowling. A calibrated dipstick attached to the filler cap indicates the oil level. Due to the canted position of the engines, the dipsticks are calibrated for either right or left engines and are not interchangeable.

The oil and oil filter should be changed every 100 hours under normal operating conditions. The oil drain is accessible through the cowl flap opening. The engines should be warmed to operating temperature to assure complete draining of the oil.

1. Remove the cowling plug button below the aft inboard corner of the oil sump.
2. Open the oil drain valve
3. Remove the oil filter and replace with a new unit. A torque of 18 to 20 foot-pounds should be applied to the nut of the oil filter.
4. Close oil drain valve and fill with oil.

Moisture that may have condensed and settled in the oil sump should be drained occasionally by opening the oil drain plug and allowing a small amount of oil to escape. This is particularly important in winter, when the moisture will collect rapidly and may freeze.

The engine manufacturer specifies ashless dispersant oils only. However, for the first 20 hours, MIL-C-6529 Type II Multiviscosity 20W-50 Corrosion-Preventive Oil is used. It is recommended that this oil be removed and the oil filter changed at 20 hours of engine operation (not to exceed 25 hours). If oil consumption has not stabilized at this point, MIL-L-6082 Mineral Oil may be used. After the break-in period, when oil consumption has stabilized, MIL-L-22851 Ashless

Dispersant Oil should be used. Oils must meet the latest revision of Teledyne Continental Motors Corporation Specification MHS-24 or the most current applicable Teledyne Continental Service Bulletin. Refer to APPROVED ENGINE OILS.

Aviation Grade Oil	Average Ambient Air Temperature
SAE 50	Above 5°C (40°F)
SAE 30	Below 5°C (40°F)

BATTERY

The battery is accessible by opening the forward baggage compartment door and removing the battery box cover from the floor of the compartment. Check the electrolyte level after each 25 hours of operation and add distilled water as necessary. Avoid filling over the baffles and never fill more than one-quarter inch over the separator tops. Excessive water consumption may be an indication that the voltage regulators require resetting.

The battery box is vented overboard to dispose of electrolyte and hydrogen gas fumes discharged during the normal charging operation. To ensure disposal of these fumes the vent hose connections at the battery box should be checked frequently for obstructions.

TIRES

An inflation pressure of 52 to 56 psi should be maintained on the 6.50 x 8 main wheel tires. The 5.00 x 5 nose wheel tire should be inflated to 55-60 psi. Maintaining recommended tire inflation will minimize tread wear and aid in

preventing tire failure caused from running over sharp stones and ruts. When inflating tires, visually inspect them for cracks, breaks, or evidence of internal damage.

CAUTION

Beech Aircraft Corporation cannot recommend the use of recapped tires. Recapped tires have a tendency to swell as a result of the increased temperature generated during takeoff. Increased tire size can jeopardize proper function of the landing gear retract system, with the possibility of damage to the landing gear doors and retract mechanism.

SHOCK STRUTS

CAUTION

DO NOT taxi with a flat shock strut.

The shock struts are filled with compressed air and hydraulic fluid. The same procedure is used for servicing both the main and the nose gear shock struts. To service a strut, proceed as follows:

1. Jack the airplane, remove the air valve cap, depress the valve core, and allow the strut to fully deflate.

WARNING

Do not unscrew the valve body assembly until all air pressure has been released or it may be blown off with considerable force, causing injury to personnel or damage to equipment.

2. Carefully remove the valve body assembly.
3. Compress the strut and fill through the air valve assembly hole with hydraulic fluid (approximately one pint) until the fluid overflows.

4. Cycle the strut from full extension to compressed and refill. Repeat until no more fluid can be added to the strut in the compressed position.

NOTE

Cycling of the shock strut is necessary to expel any trapped air within the strut housing.

5. Install the air valve assembly.
6. With the airplane resting on the ground and the fuel cells full, inflate the nose gear strut until 3-1/2 to 3-3/4 inches of the piston are exposed and inflate the main gear struts until 3 inches of the piston are exposed. Rock the airplane gently to prevent possible binding of the piston in the barrel while inflating.

NOTE

It is recommended that the nose strut inflation dimension and the tire inflation pressures be carefully adhered to. Properly inflated tires and struts reduce the possibility of ground damage occurring to the propellers. Exercise caution when taxiing over rough surfaces.

7. Remove all foreign material from the exposed piston with a soft cloth moistened with hydraulic fluid.

CAUTION

If a compressed air bottle containing air under extremely high pressure is used, exercise care to avoid over-inflating the shock strut.

WARNING

NEVER FILL SHOCK STRUTS WITH OXYGEN.

INTENTIONALLY LEFT BLANK

SHOCK STRUT SHIMMY DAMPER

The shimmy damper has a reservoir of fluid carried in the piston rod. Two coil springs installed in the piston rod keep the fluid in shimmy damper under pressure. As fluid is lost through leakage it is automatically replenished from the reservoir until the reservoir supply is exhausted.

To check the fluid level in the shimmy damper, insert a wire, approximately 1/32 inch in diameter, through the hole in the disc at the aft end of the piston rod until it touches the bottom of the hole in the floating piston. Mark the wire, remove it, and measure the depth of the insertion. When the shimmy damper is full, insertion depth is 2-3/16 inches, when empty, 3-1/16 inches.

NOTE

The measuring wire should be inserted in the hole in the floating piston rather than against the piston face to give a more accurate reading. To determine if the wire is inserted in the hole in the floating piston, insert the wire several times, noting insertion depth each time. When the wire is inserted in the hole, the depth will be about 1/4 inch greater than when it rests against the piston face.

When the shimmy damper is found empty or nearly empty, it should be refilled. See Shop Manual.

BRAKES

The brake hydraulic fluid reservoir is accessible through the nose baggage compartment. A dipstick is attached to the reservoir cap. Refer to Consumable Materials for hydraulic fluid specification.

The brakes require no adjustments since the pistons move to compensate for lining wear. The brake linings should be replaced before the metal back plate is exposed through the abrasive surface. The minimum allowable thickness for the abrasive surface is .010 inch. The brake disc should be replaced when its thickness measures .330 inch.

INDUCTION AIR FILTERS

The filters should be inspected for foreign matter at least once during each 50-hour operating period. In adverse climatic conditions, or if the airplane is stored, preflight inspection is recommended.

TO REMOVE AND CLEAN THE FILTER:

1. Remove the access plate in the top of the engine cowling.
2. Remove the filter and clean as noted by the manufacturer's instructions.
3. Reinstall the filter and the plate.

PROPELLERS

The daily preflight inspection should include a careful examination of the propeller blades for nicks and scratches.

Propeller operation, servicing, and maintenance instructions are contained in the propeller owner's manual furnished with the airplane.

WARNING

When servicing a propeller, always make certain that the ignition switch is off and that the engine has cooled completely. **WHEN MOVING A PROPELLER, STAND IN THE CLEAR; THERE IS ALWAYS SOME DANGER OF A CYLINDER FIRING WHEN A PROPELLER IS MOVED.**

Air pressure settings (HARTZELL):

70° to 100°F	41 psi
40° to 70°F	38 psi
0° to 40°F	36 psi
-30° to 0°F	33 psi

PROPELLER BLADE BEARING LUBRICATION

1. Remove the propeller spinner.
2. Remove the safety wire and covers from grease zerks.
3. Remove one zerk from each blade.
4. Lubricate by placing the grease gun fitting on one zerk of each blade and filling until the grease is visible from the zerk opening on the opposite side of the blade.
5. Clean the excess grease from the propeller, reinstall the grease zerks, covers, and safety wire on each blade.
6. Reinstall the spinner.

PROPELLER AND WINDSHIELD ANTI-ICE TANK (FLUID)

The tank is located beneath the floor on the left side of the forward baggage compartment. The filler cap is accessible through an access door in the floor of the compartment. Capacity is 3 U.S. gallons of anti-ice fluid (see Consumable Materials). The tank should be drained and flushed twice a year.

OXYGEN SYSTEM

WARNING

Keep hands, tools, clothing, and oxygen equipment clean and free from grease and oil. **KEEP FIRE AWAY FROM OXYGEN.**

1. Read the pressure indicator on the oxygen console. (The shutoff valve on the oxygen cylinder must be open.) If the oxygen cylinder is equipped with a gage, system pressure may be checked at the cylinder.

CAUTION

Always open the cylinder shutoff valve slowly to prevent damage to the system.

2. Make certain that the oxygen control valve is closed (PUSH IN).
3. Close the cylinder shutoff valve, remove the cap from the filler valve, and attach the recharging outlet. Open valve on supply bottle.
4. Open the cylinder shutoff valve and fill the cylinder to 1800 + 50 psi (add 3.5 psi per degree above 70°F; subtract 3.5 psi per degree below 70°F).
5. Close the cylinder shutoff valve, close valve on the supply bottle, remove the recharging outlet, and replace the filler valve cap.
6. Reopen the cylinder shutoff valve to prepare system for use.

OXYGEN CYLINDER RETESTING

Oxygen cylinders used in the airplane are of two types. Light weight cylinders, stamped "3HT" on the plate on the side, must be hydrostatically tested every three years and the test date stamped on the cylinder. This bottle has a service life of 4,380 pressurizations or twenty-four years, whichever occurs first, and then must be discarded. Regular weight cylinders, stamped "3A", or "3AA", must be hydrostatically tested every five years and stamped with the retest date. Service life on these cylinders is not limited.

MINOR MAINTENANCE

RUBBER SEALS

To prevent sticking of the rubber seals around the windows, doors, and engine cowling, the seals should be coated with Oakite 6 compound. The compound is noninjurious to paint and can be removed by employing normal cleaning methods.

HEATING AND VENTILATING SYSTEM

The heater fuel pump filter in the nose wheel well should be removed and cleaned after each 100 hours of airplane operation. Remove the filter by turning the base of the pump counterclockwise. Wash the filter in fresh cleaning solvent (see Consumable Materials) and dry with compressed air.

The iris valve at the heater blower inlet should be lubricated occasionally with molybdenum disulfide (see Consumable Materials). The valve should never be lubricated with oil or any liquid lubricant which would collect dust.

Do not reset the overheat circuit breaker until a thorough inspection of the system has determined the cause and the malfunction has been corrected.

ALTERNATORS

Since the alternator and electronic voltage regulator are designed for use on only one polarity system, the following precautionary measures must be observed when working on the charging circuit, or serious damage to the electrical equipment will result:

1. When installing a battery, make certain that the ground polarity of the battery and the ground polarity of the alternator are the same.
2. When connecting a booster battery, be sure to connect the negative battery terminals together and the positive battery terminals together.
3. When using a battery charger, connect the positive lead of the charger to the positive battery terminal and the negative lead of the charger to the negative battery terminal.
4. Do not operate an alternator on open circuit. Be sure all circuit connections are secure.
5. Do not short across or ground any of the terminals on the alternator or electronic voltage regulator.
6. Do not attempt to polarize an alternator.

MAGNETOS

Ordinarily, the magnetos will require only occasional adjustment, lubrication, and breaker point replacement. This work should be done by a BEECHCRAFT Aero or Aviation Center or International Distributor or Dealer.

WARNING

To be safe, treat the magnetos as hot whenever a switch lead is disconnected at any point; they do not have an internal automatic grounding device. Otherwise, all spark plug leads should be disconnected or the cable outlet plate on the rear of the magneto should be removed.

CLEANING

EXTERIOR PAINTED SURFACES

WARNING

Do not expose control surface trim tab hinge lines and their pushrod systems to the direct stream or spray of high-pressure, soap-and-water washing equipment. Fluid dispensed at high pressure could remove the protective lubricant, allowing moisture from heavy or prolonged rain to collect at hinge lines, and then to freeze at low temperatures. After high-pressure or hand washing, and at each periodic inspection, lubricate trim tab hinge lines and trim tab pushrod end fittings (Brayco 300 per Federal Specification VV-L-800 preferred). See Consumable Materials.

CAUTION

When cleaning landing gear areas with solvent, especially if high-pressure equipment is used, exercise care to avoid washing away grease from landing gear components. After washing the landing gear areas with solvent, lubricate all lubrication points, or premature wear may result.

Do not apply wax, polish, rubbing compound, or abrasive cleaner to any uncured painted surface. Use of such items can permanently damage the surface finish. Also, waxes and polishes seal the paint from the air and prevent curing.

Alkyd enamel (sometimes called "automotive enamel"), acrylic enamel, lacquer, and dope

CAUTION

finishes require a curing period of approximately 90 days; Acrylic urethane, polyester urethane, and epoxy finishes undergo a curing process for a period of 30 days after application. Wash uncured painted surfaces with a mild non-detergent soap (MILD detergents can be used on urethane finishes) and cold or luke-warm water only. Use soft cloths, keeping them free of dirt and grime. Any rubbing of the surface should be done gently and held to a minimum to avoid damaging the paint film. Rinse thoroughly with clear water. Stubborn oil or soot deposits may be removed with automotive tar removers.

Prior to cleaning, cover the wheels, making certain the brake discs are covered. Attach the pitot cover securely, and plug or mask off all other openings. Be particularly careful to mask off all static air buttons before washing or waxing. Use special care to avoid removing lubricant from lubricated areas.

When using high-pressure washing equipment, keep the spray or stream clear of wheel bearings, propeller hub bearings, etc., and openings such as pitot tubes, static air buttons, and battery and avionics equipment cooling ducts, which should be securely covered or masked off. Avoid directing high-pressure sprays toward the fuselage, wings, and empennage from the rear, where moisture and chemicals might more easily enter the structure, causing corrosion damage to structural members and moving parts.

Hand washing may be accomplished by flushing away loose dirt with clean water, then washing with a mild soap and water, using soft cleaning cloths or a chamois. Avoid harsh, abrasive, or alkaline soaps or detergents which could cause

corrosion or scratches. Thorough clear-water rinsing prevents buildup of cleaning agent residue, which can dull the paint's appearance. To remove oily residue or exhaust soot, use a cloth dampened with an automotive tar remover. Wax or polish the affected area, if necessary.

There is some variation in the procedures required for proper care of the several types of exterior paint. During the curing period, do not make prolonged flights in heavy rain or sleet, and avoid all operating conditions which might cause abrasion or premature finish deterioration. Alkyd enamel, lacquer, and dope finishes must be polished and waxed periodically to maintain luster, and to assure protection from the weather. Acrylic enamel should be waxed, and may be polished, if desired. Acrylic urethane may be waxed for protection from the elements, but should not be polished unless polishing or buffing is required to restore a damaged area. Waxing of polyester urethane finishes, although not required, is permitted; however, never use abrasive cleaner type waxes, polishes, or rubbing compounds, as these products cause eventual deterioration of the characteristic urethane gloss. Epoxy finishes should be waxed on a regular basis, and may be polished and buffed to restore appearance should "chalking" occur. For waxing, select a high quality automotive or aircraft waxing product. Do not use a wax containing silicones, as silicone polishes are difficult to remove from surfaces. A buildup of wax on any exterior paint finish will yellow with age; therefore, wax should be removed periodically. Generally, aliphatic naphtha (see Consumable Materials) is adequate and safe for this purpose.

NOTE

Before returning the airplane to service, remove all maskings and coverings, and re-lubricate as necessary.

WINDSHIELD AND WINDOWS

The windshield and plastic windows should be kept clean and waxed at all times. To prevent scratches wash the windows carefully with plenty of soap and water, using the palm of the hand to feel and dislodge dirt and mud. A soft cloth, chamois or sponge may be used, but only to carry water to the surface. Rinse thoroughly, then dry with a clean, moist chamois. Rubbing the surface of the plastic with a dry cloth builds up an electrostatic charge which attracts dust particles in the air.

Remove oil and grease with a cloth moistened with isopropyl alcohol. Never use gasoline, benzine, alcohol, acetone, carbon tetrachloride, fire extinguisher fluid, anti-ice fluid, lacquer thinner or glass cleaner. These materials will soften plastic and may cause it to craze.

After thoroughly cleaning, the surface should be waxed with a good grade of commercial wax. The wax will fill in the minor scratches and help prevent further scratching. Apply a thin, even coat of wax and bring it to a high polish by rubbing lightly with a clean, dry, soft flannel cloth. Do not use a power buffer; the heat generated by the buffing pad may soften the plastic.

SURFACE DEICE BOOTS

The surfaces of the deice boots should be checked for indication of engine oil after servicing and at the end of each flight. Any oil spots that are found should be removed with a non-detergent soap and water solution. Care should be exercised during cleaning. Avoid scrubbing the surface of the boots as this will tend to remove the special graphite surfacing. The deice boots are made of soft, flexible stock which may be damaged if gasoline hoses are dragged over the surface of the boots or if ladders and platforms are rested against them.

ENGINE

Clean the engine with neutral solvent. Spray or brush the fluid over the engine, then wash off with water and allow to dry. Solutions which may attack rubber or plastics should not be used.

INTERIOR

To remove dust and loose dirt from the upholstery, headliner, and carpet, clean the interior regularly with a vacuum cleaner.

Blot up any spilled liquid promptly with cleansing tissue or rags. Do not pat the spot; press the blotting material firmly and hold it for several seconds. Continue blotting until no more liquid is taken up. Scrape off sticky materials with a dull knife; then spot-clean the area.

Oily spots may be cleaned with household spot removers, used sparingly. Before using any solvent, read the instructions on the container and test it on an obscure place on the fabric to be cleaned. Never saturate the fabric with a volatile solvent; it may damage the padding and backing materials.

Soiled upholstery and carpet may be cleaned with foam-type detergent used according to the manufacturer's instructions. To minimize wetting the fabric, keep the foam as dry as possible and remove it with a vacuum cleaner.

The plastic trim, instrument panel, and control knobs need only be wiped with a damp cloth. Oil and grease on the control wheel and control knobs can be removed with a cloth moistened with isopropyl alcohol. Volatile solvent, such as mentioned in the article on care of plastic windows should never be used since they often craze the plastic.

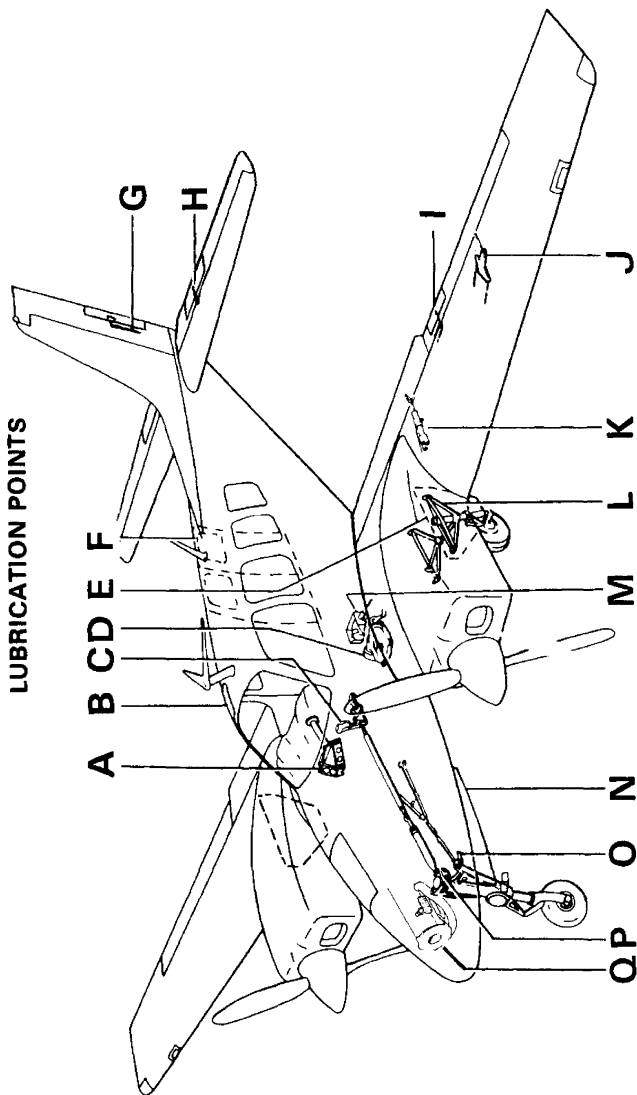

A

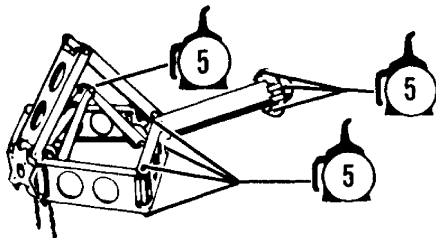

CONTROL COLUMN LINKAGE

B

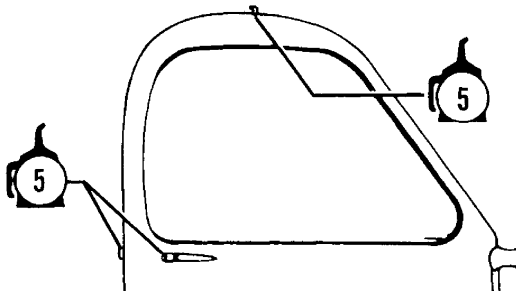

CABIN DOOR

C

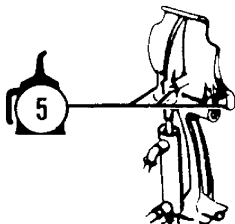

RUDDER PEDALS

D

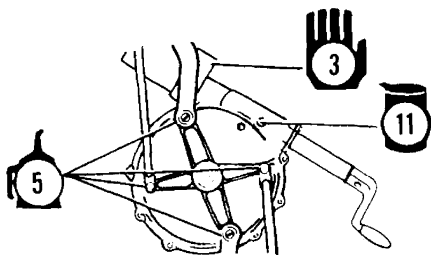

LANDING GEAR BOX

58-604-45

E

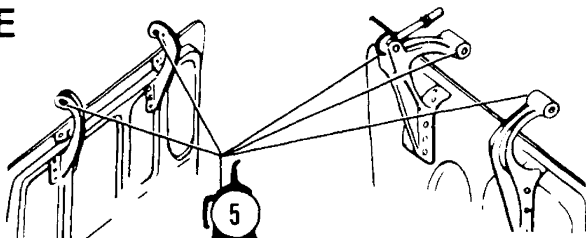

MAIN LANDING GEAR DOOR HINGES

58-604-46

F

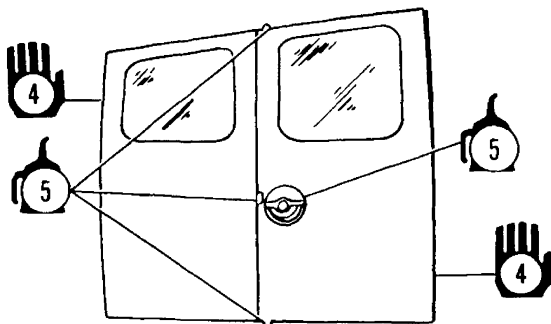

UTILITY DOOR

58-604-47

G

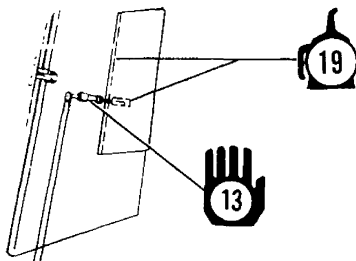

RUDDER TAB

58-604-48

H

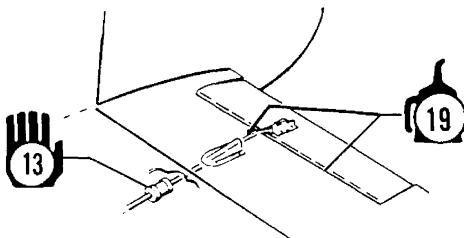

ELEVATOR TAB

58-604-49

I

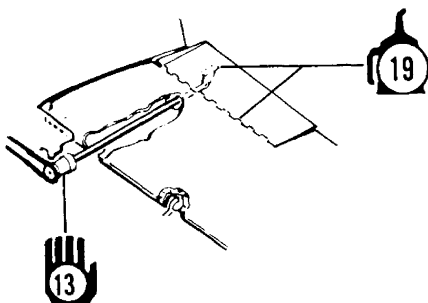

AILERON TAB

58-604-50

J

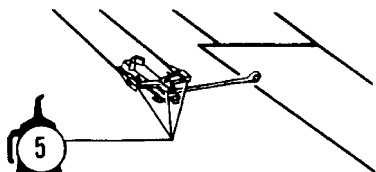

AILERON BELL CRANKS

58-604-51

K

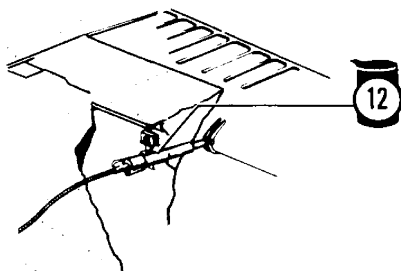

FLAP ACTUATOR

58-604-52

L

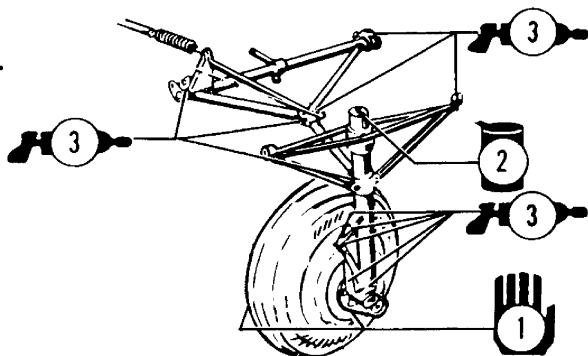

MAIN GEAR RETRACT

58-604-53

M

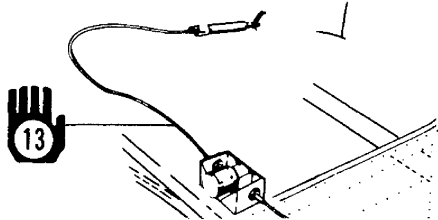

FLAP MOTOR GEAR BOX

58-604-54

N

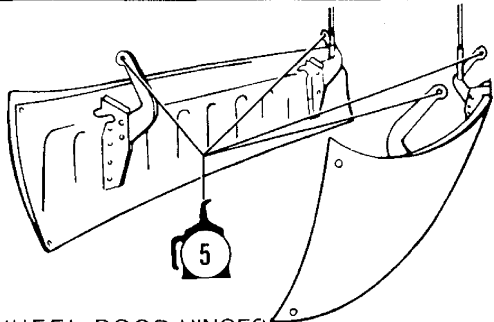

NOSE WHEEL DOOR HINGES

58-604-55

O

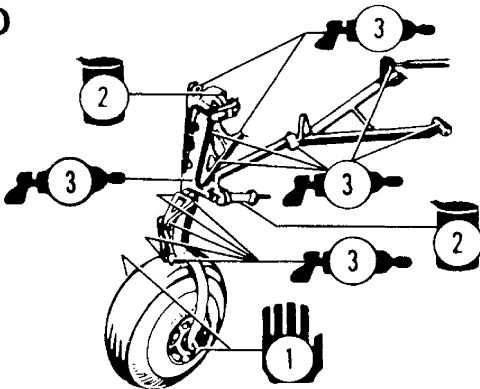

NOSE GEAR RETRACT

58-604-56

P

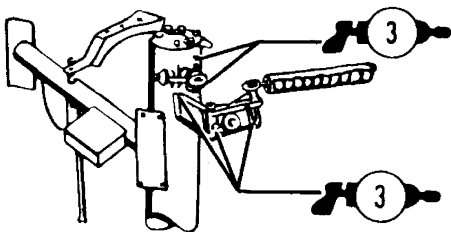

NOSE WHEEL STEERING

Q

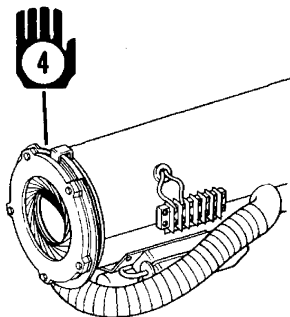

HEATER IRIS VALVE



HAND OR PACK



ZERK FITTING



FLUID CONTAINER



SQUIRT CAN

NOTE: Letters are keyed to the Service Schedule; Numbers refer to items in the Consumable Materials Chart.

RECOMMENDED SERVICING SCHEDULE

INTERVAL	ITEM	LOCATION (Letters refer to Lubrication Points Diagram)	(Number refers to item on Consumable Materials)
Pre-flight	Check engine oil level Drain main fuel cell drains Drain fuel strainer drains Drain box section cell Service fuel cells	Access door on upper cowling Lower wing surface (leading edge) Wing surface fwd of main wheel well Aft bottom wing surface Top of wings, leading edge	6 - - - 7
25 Hrs.	Check battery electrolyte	Fwd baggage compartment under floor	See Shop Manual

RECOMMENDED SERVICING SCHEDULE

INTERVAL	ITEM	LOCATION (Letters refer to Lubrication Points Diagram)	(Number refers to item on Consumable Materials)
50 Hrs.	Clean induction air filter	Access plate, induction scoop	
100 Hrs	Change engine oil Replace engine oil filter Clean fuel strainers Clean fuel injection control valve screen Clean heater fuel pump filter Lubricate trim tab hinges and push rods	Through cowl opening Access plate on left cowling door In wheel wells Access door on side of nacelle Nose wheel well Empennage (G, H) Aileron (I)	6 Hastings oil filter P-128 *9 *9 *9 19

* Clean with solvent and blow dry with compressed air.

100 Hrs. (Cont.)	Lubricate landing gear uplock rollers	Main landing gear (L)	13
	Clean and check spark plugs	Under cowl, both sides engine	-
	Check magneto timing	Engine compartment	-
	Lubricate landing gear door hinges	Landing gear wheel wells (E) (N)	5
	Lubricate nose wheel steering mechanism	Nose wheel well (P)	3
	Lubricate landing gear retract mechanism	Nose wheel and main gear wheel wells (O) (L)	3
	Lubricate wheel bearings	Landing gear (O) (L)	1
	Lubricate cabin door mechanism	Cabin door latch (B)	5
	Lubricate aileron bell cranks	Access panel underside wings (J)	5
	Lubricate control column linkage	Forward of instrument panel (A)	5
	Lubricate rudder pedals	Cockpit (C)	5
	Drain static air lines	Left forward cabin sidewall	-
	Utility door latch and hinges	Cabin, right side (F)	4, 5

RECOMMENDED SERVICING SCHEDULE

INTERVAL	ITEM	LOCATION (Letters refer to Lubrication Points Diagram)	(Number refers to item on Consumable Materials)
300 Hrs.	Rod end bearings Service landing gear actuator gear box	Control system and landing gear Under front seats (D)	Oil or grease as required 11
500 Hrs.	Replace pressure system filters Replace pressure system inlet filter	Aft of engine firewall Rear engine baffle	Airborne IJ4-7 Airborne D9-14-1
600 Hrs	Service landing gear motor-reduction gears	Under front seats (D)	3
900 Hrs	Lubricate flap actuators and flexible drive shafts	Forward of flap (K) Underside of wing (M)	12 13

1000 Hrs.	Lubricate rudder and elevator trim tab actuators	Empennage (G, H)	13
	Lubricate aileron trim tab actuators	Aileron (I)	13
As Req.	Service wing fuel system	At wing fillers	7
	Service propeller/windshield anti-ice reservoir	Under left floorboard, forward baggage compartment	8
	Service oxygen cylinder	Nose baggage compartment	18
	Service brake fluid reservoir	Nose baggage compartment	2
	Drain moisture from engine oil sump	Through cowl flap opening	-
	Service main gear struts	Top of each strut (L)	2
	Service nose gear strut	Top of strut (O)	2
	Service shimmy damper	Nose landing gear (O)	2
	Check brake lining wear	Main landing gear wheels	-
	Lubricate heater iris	Forward nose compartment (Q)	4

RECOMMENDED SERVICING SCHEDULE

INTERVAL	ITEM	LOCATION (Letters refer to Lubrication Points Diagram)	(Number refers to item on Consumable Materials)
†	Battery for emergency locator transmitter (Replace)	On right side of aft fuselage access through left side access panel	-

† Rechargeable Batteries: Recharge after one cumulative hour of use or after 50% of the useful charge life.

Non-Rechargeable Batteries: Replace after one cumulative hour or after 50% of the useful life.

CONSUMABLE MATERIALS

Only the basic number of each Military Specification is included in the Consumable Materials Chart. No attempt has been made to update the basic number with the letter suffix that designates the current issues of the various specifications.

Vendors listed as meeting Federal and Military Specifications are provided as reference only and are not specifically recommended by Beech Aircraft Corporation; consequently, any product conforming to the specification listed may be used. The products listed below have been tested and approved for aviation usage by Beech Aircraft Corporation, by the vendor, or by compliance with the applicable specifications. Other products that are locally procurable which conform to the requirements of the applicable Military Specification may be used even though not specifically included herein.

It is the responsibility of the operator/user to determine the current revision of the applicable Military Specification prior to usage of that item. This determination may be made by contacting the vendor of a specific item.

CONSUMABLE MATERIALS

ITEM	MATERIAL	SPECIFICATION
1.	Lubricating Grease Wheel Bearing	Aeroshell No. 5 or MIL-G-81322

CAUTION

Do not mix Aeroshell No. 5 with MIL-G-81322. Thoroughly clean grease from bearings and bearing area before changing grease.

Section VIII
Handling, Serv - Maint

BEEHCRAFT Baron 58
Serial TH 773 and After

<i>ITEM</i>	<i>MATERIAL</i>	<i>SPECIFICATION</i>
2.	Hydraulic Fluid	MIL-H-5606
*3.	Lubricating Grease, General Purpose, Wide Temperature	MIL-G-81322
4.	Molybdenum Disulfide	MIL-M-7866
5.	Lubricating Oil	SAE No. 20 or SAE 10W-30
**6.	Engine Oil	SAE 30 (Below 40°F) SAE 50 (Above 40°F) Approved Multi- viscosity Oils
***7.	Engine Fuel	Grade 100LL (Blue) preferred, 100 (Green)
8.	Anti-Ice Fluid	MIL-F-5566
9.	Solvent	Federal Specification, PD680
10.	Lubricant	Scintilla 10-86527
11.	Lubricant	Mobil Compound GG or Mobil 636
12.	Lubricating Oil, Gear	MIL-L-10324, or MIL-L-2105C, Grade 75W

**BEECHCRAFT Baron 58
Serial TH 773 and After**

**Section VIII
Handling, Serv - Maint**

<i>ITEM</i>	<i>MATERIAL</i>	<i>SPECIFICATION</i>
13.	Grease, Aircraft and Instrument	MIL-G-23827
†14.	Lubricant, Rubber Seal	Oakite 6 Compound
15.	Naphtha, Aliphatic	Federal Specification, TT-N-95
††16.	Tape, Antiseize Tetrafluorethylene	MIL-T-27730
17.	Leak Test Compound, Oxygen Systems	MIL-L-25567
18.	Oxygen, Aviator's Breathing	MIL-O-27210
19.	Lubricating Oil, General Purpose, Preservative (Water- Displacing, Low Temperature)	●Brayco 300 per Federal Specifi- cation VV-L-800 (Preferred)

Alternates for Brayco 300:

Lubricant	●●CRC 3-36
	●●●LPS No. 1
	●●●●WD-40

* In extremely cold climates use MIL-G-23827 grease in place of MIL-G-81322. (These greases harmful to paint.)

** Ashless dispersant oil (latest revision of Teledyne Continental Motors Corp. Spec. MHS-24) recommended; straight mineral oils recommended during break-in period. See servicing data.

*** If 100LL grade fuel (blue) is not available, use 100 (green) as minimum grade. See Engine Manufacturer's Service Letter for recommended maintenance and servicing techniques.

● Product of Bray Oil Co.,
1925 North Marianna
Los Angeles, Calif. 90032

●● Product of CRC Chemicals, Inc.,
Warminster, Pa. 18974

●●● Product of LPS Research Laboratories, Inc.,
2050 Cotner Ave,
W. Los Angeles, Calif. 90025

●●●● Product of WD-40 Company,
1061 Cudahy Place,
San Diego, Calif. 92110

† Product of Oakite Products, Inc., 50 Valley Road,
Berkley Heights, N.J. 07922.

†† For sealing tapered pipe threads on high pressure oxygen lines.

APPROVED ENGINE OILS

COMPANY	BRAND AND WEIGHT
BP Oil Corporation	B/P Aero Oil D65/80
Castrol Limited (Australia)	Grade 40, Castrolaero AD, Type III Grade 50, Castrolaero AD, Type II
Continental Oil Co.	Conoco Aero S (SAE 10W/30)
Delta Petroleum Co.	Delta Avoil - Grades 30, 40 - 50
Gulf Oil Corporation	Gulfpride Aviation AD
Humble Oil & Refining Company	Esso Aviation Oil Enco Aviation Oil
Pennzoil Company	Pennzoil Aircraft Engine Oil, Heavy Duty Dispersant, Grades 30, 40, 50
Phillips Petroleum Co.	Phillips 66 Aviation Oil Type A (Replaced HD Aviation Oil)
Quaker State Oil Refining Corp.	Quaker State AD Aviation Engine Oil Grades 20W/30, 40 - 50

COMPANY

BRAND AND WEIGHT

Shell Oil Company	Aeroshell Oil W (in 4 grades) Grade 120 (Nominal SAE 60) - Military Grade 1120 Grade 100 (Nominal SAE 50) - Military Grade 1100 Grade 80 (Nominal SAE 40) - Military Grade 1080 Grade 65 (Nominal SAE 20 or 30) - Military Grade 1065
Sinclair Refining Co.	Sinclair Avoil 20W-40
Socony-Mobil	Mobil Aero Oil 65 Ashless Mobil Aero Oil 80 Dispersant Mobil Aero Oil 100 Aviation Mobil Aero Oil 120 Engine Oil
Texaco, Inc.	Texaco Aircraft Engine Oil - Premium AD, Grades 65, 80, 100
Union Oil Co. of California	Union Aircraft Engine Oil HD Grades 80 - 100

NOTE

This chart lists all oils which were certified as meeting the requirements of Teledyne Continental Motors Corporation Specification MHS-24B at the time this handbook was published. Any other oil which conforms to this specification may be used.

BULB REPLACEMENT GUIDE

LOCATION	NUMBER
Compass light	327
Dome light, cabin	1864
Electrical panel light	327
Flap position indicator light	356
Ice light	A-7079B-24
Instrument light, flood	313
Instrument light, post	327
Landing gear position light	327
Landing light	4596
Map light	1495
Navigation light, tail	93
Navigation light, tail w/strobe	701557-6-SDI, or 30-0815-5 Grimes
Navigation light, wing	A7512-24 Grimes
Alternator out light	327
Reading light	303
Rotating beacon	A-7079B-24 Grimes
Tab position indicator light	1819
Taxi light (if installed)	4596

OVERHAUL OR REPLACEMENT SCHEDULE

The first overhaul or replacement should be performed not later than the required period. The condition of the item at the end of the first period can be used as a criterion for determining subsequent periods applicable to the individual airplane or fleet operation, providing the operator has an approved monitoring system.

The time periods for inspection noted in this handbook are based on average usage and average environmental conditions.

SPECIAL CONDITIONS CAUTIONARY NOTICE

Airplanes operated for Air Taxi or other than normal operation and airplanes operated in humid tropics or cold and damp climates, etc., may need more frequent inspections for wear, corrosion and/or lack of lubrication. In these areas periodic inspections should be performed until the operator can set his own inspection periods based on experience.

NOTE

The required periods do not constitute a guarantee that the item will reach the period without malfunction, as the aforementioned factors cannot be controlled by the manufacturer.

COMPONENT

OVERHAUL OR REPLACE

NOTE

Any time the control surfaces are altered, repaired, or repainted, they must be rebalanced per Shop Manual.

MISCELLANEOUS

Seat belts or Shoulder Harnesses	Inspect every 12 months, replace on condition
Hand fire extinguisher	Inspect every 12 months, recharge as necessary

*Refer to Continental Service Bulletin M74-20, Rev. 1 or later issue, for detailed overhaul period instructions.

With particular attention to throttle response, smooth power and oil consumption, a qualified certificated mechanic must determine that the engine is operating normally at the time of each periodic inspection.

INTENTIONALLY LEFT BLANK

SECTION IX

SUPPLEMENTS

NOTE

The supplemental data contained in this section is for equipment that was delivered on the airplane including standard optional equipment that was available, whether it was installed or not. Supplements for equipment for which the vendor obtained a Supplemental Type Certificate were included as loose equipment with the airplane at the time of delivery. These and other supplements for other equipment that was installed after the airplane was delivered new from the factory should be placed in this Supplemental Data Section IX, of this Pilot's Operating Handbook and FAA Approved Airplane Flight Manual.

INTENTIONALLY LEFT BLANK

**RAYTHEON AIRCRAFT
BEECH® BARON 58/58A
PILOT'S OPERATING HANDBOOK
and
FAA APPROVED AIRPLANE FLIGHT MANUAL
P/N 58-590000-21
LOG OF SUPPLEMENTS**

<i>FAA Supplements must be in the airplane for flight operation when subject equipment is installed.</i>			
Part Number	Subject	Rev No.	Date
96-590010-19	King KN-74 Area Navigation System	1	2/79
96-590010-21	Nickel-Cadmium Battery and Charge Current Detector		10/76
SA773CE	Hartzell Propellers	3	3/25/76
96-590010-23	100-Amp. Alternator		10/76
96-590011-21	Bendix NP-2041A NAV Computer Programmer	1	1/80
58-590000-23	Air Conditioning System	3	10/83
58-590000-25	AirData AD611/D Area Navigation		6/21/77
106-590000-15	Collins ANS-351 Area Navigation System		11/16/77
58-590000-27	AirData AD-511 AD-511G Area Navigation System	1	7/79
102-590000-45	KNC-610 Area Navigation System		11/78
58-590000-29	King KNS-80 Integrated Navigation System		1/79
96-590010-27	Narco RNAV 161 Multi-Waypoint Area Navigation System		1/79
102-590000-53	King KNS-81 Integrated Navigation System	1	10/83
58-590000-37	Dual Voltage Regulators (Kit No. 55-3024)		5/84
58-590000-33	Flight In Icing Conditions (Furnished Only When Kit No. 58-5012 Installed)	2	9/98
58-590000-49	Inside Cabin Door Handle With Open/Closed Placard		12/90
36-590002-47	Full Flap Warning Horn System		12/90
36-590002-49	Landing Gear Warning Light System		12/90

NOTE: *Supplements applicable to equipment other than that installed may, at the discretion of the owner/operator, be removed from the manual.*

** Supplements marked with an asterisk will not be supplied with handbooks sold through Authorized Beech Outlets due to their limited applicability. If a document is required for your airplane, please order the document through normal channels.*

**BEECHCRAFT BARONS 95-B55,
95-B55A, E55, E55A, 58, 58A LANDPLANES**

**PILOT'S OPERATING HANDBOOK AND
FAA APPROVED AIRPLANE FLIGHT MANUAL
SUPPLEMENT**

for the

**KING KN-74
AREA NAVIGATION SYSTEM**

GENERAL

The information in this supplement is FAA approved material and must be attached to the Pilot's Operating Handbook and FAA Approved Airplane Flight Manual when the airplane is equipped with a King KN-74 Area Navigation System which has been installed in accordance with BEECHCRAFT FAA approved data.

The information in this supplement supersedes or adds to the basic Pilot's Operating Handbook and FAA Approved Airplane Flight Manual only as set forth below.

LIMITATIONS

1. This system shall not be used as a primary system under IFR conditions except on approved approach procedures, approved area navigation airways, and random area navigation routes when approved by Air Traffic Control..

2. This system is to be used only with colocated facilities (VOR and DME signals originate from the same geographical location).

FAA Approved
Revised: February, 1979
P/N 96-590010-19

EMERGENCY PROCEDURES

CAUTION

DME may unlock due to loss of signal with certain combinations of distance from station, altitude, and angle of bank.

1. VOR or Distance flag appears while in RNAV mode:
 - a. Selected Frequency - CHECK FOR CORRECT FREQUENCY
 - b. VOR or Distance Flag Intermittent or Lost - UTILIZE OTHER NAV EQUIPMENT AS REQUIRED
2. VOR or Distance flag appears while in APPR mode:
 - a. If flag appears while in an approach, execute published missed approach and utilize other approved facility.

NORMAL PROCEDURES

1. VHF NAV - ON
2. DME - ON
3. Mode Selector - SELECT VOR/DME, RNAV, or APPR
4. NAV Frequency - SET
5. DME Frequency - SET
6. Waypoint Bearing - SET WAYPOINT RADIAL FROM VORTAC
7. Waypoint Distance - SET WAYPOINT DISTANCE FROM VORTAC
8. OBS Control - DESIRED MAGNETIC HEADING
9. Self-Test - PRESS BUTTON (must have VOR reception)

FAA Approved
Revised: February, 1979
P/N 96-590010-19

PERFORMANCE - No change

Approved:

for 
W. H. Schultz
Beech Aircraft Corporation
DOA CE-2

FAA Approved
Revised: February, 1979
P/N 96-590010-19

3 of 3

**BEECHCRAFT BARONS 95-B55,
95-B55A, E55, E55A, 58, 58A LANDPLANES**

**PILOT'S OPERATING HANDBOOK AND
FAA APPROVED AIRPLANE FLIGHT MANUAL
SUPPLEMENT**

for the

**NICKEL-CADMIUM BATTERY
AND
CHARGE CURRENT DETECTOR**

GENERAL

The information in this supplement is FAA Approved material and must be attached to the Pilot's Operating Handbook and FAA Approved Flight Manual when the airplane is equipped with a Nickel-Cadmium Battery and Charge Current Detector installed in accordance with BEECHCRAFT FAA approved data.

The Battery Charge Current Detector consists of a circuit which illuminates an amber light on the instrument panel whenever the battery charge current is above normal. The system is designed for a continuous monitor of battery condition.

The purpose of the Battery Charge Current Detector is to inform the pilot of battery charge currents which may damage the battery. The system senses all battery current and provides a visual indication of above normal charge current. Following a battery engine start, the battery recharge current is very high and causes the illumination of the BATTERY CHARGE light, thus providing an automatic self test of the detector and the battery. As the battery approaches a full charge and the charge current decreases to a satisfactory amount, the light will extinguish. This will normally occur within a few minutes after an engine start, but may

require a longer time, if the battery has a low state of charge, low charge voltage per cell (20 cells battery), or low battery temperature.

The light may occasionally reappear for short intervals when heavy loads switch off, or engine speeds are varied near generator cut-in speed. High battery temperatures or high charge voltage per cell will result in a high overcharge current which will eventually damage the battery and lead to thermal runaway. Illumination of the BATTERY CHARGE light in flight alerts the pilot that conditions may exist that may eventually damage the battery. The battery should be turned off to prevent battery damage. The following procedures outline the actions to be taken in the event the BATTERY CHARGE light illuminates.

EMERGENCY PROCEDURES

DURING CRUISE

The illumination of the amber caution light, placarded BATTERY CHARGE, in flight indicates a possible malfunction of the battery. Turn the Battery Switch - OFF. The caution light should extinguish and the flight may proceed to destination. Failure of the light to extinguish with the battery switch off indicates a battery system or a charge current detector system malfunction. The aircraft should be landed as soon as practicable. (The battery switch should be turned on for landing in order to avoid electrical transients caused by power fluctuations.) After landing perform a During Shutdown Battery Condition check.

NORMAL PROCEDURES

BEFORE STARTING ENGINES

1. Caution Light (BATTERY CHARGE) - PRESS TO TEST for illumination.

**FAA Approved
October, 1976
P/N 96-590010-21**

DURING ENGINE START

Provided sufficient energy is used from the battery during the first engine start, the amber caution light, placarded BATTERY CHARGE, will illuminate approximately 6 seconds after the generator is on the line. This indicates a charge current above normal. The light should extinguish within 5 minutes. Failure to do so indicates a partially discharged battery. Continue to charge battery. Make a check each 90 seconds using the procedure outlined below until the charge current fails to decrease and the light extinguishes. Failure of the light to extinguish indicates an unsatisfactory condition. The battery should be removed and checked by a qualified Nickel-Cadmium Battery shop.

1. One Alternator/Generator - OFF.
2. Engine Speed (Engine with Alternator/Generator On) - 1000 RPM (Voltmeter indicating approximately 28 volts).
3. After loadmeter needle stabilizes, momentarily turn the battery switch off and note the change in meter indication.

NOTE

The change in load meter indications is the battery charge current and should be no more than .025 (only perceivable needle movement) within 5 minutes. Failure to obtain a reading below .025 within 5 minutes indicates a partially discharged battery. Continue to charge battery repeating the check each 90 seconds until the charge current decreases below .025. No decrease of current between checks indicates an unsatisfactory condition. The battery should be removed and checked by a qualified Nickel-Cadmium Battery shop.

DURING SHUTDOWN

Battery - CONDITION AND CHARGE (If the BATTERY CHARGE light is extinguished, the battery is charged and the condition is good. If the light is illuminated and fails to extinguish within 3 minutes of charging, perform the following check:

1. One Alternator/Generator - OFF.
2. Engine Speed (Engine with Alternator/Generator ON) - 1000 RPM (Voltmeter indicating approximately 28 volts).
3. After loadmaster needle stabilizes, momentarily turn the battery switch off and note change in meter indication.

NOTE

The change in loadmeter indication is the battery charge current and should be no more than .025 (only perceivable needle movement). If the result of this check is not satisfactory, allow the battery to charge repeating the check each 90 seconds. If the results are not satisfactory within 3 minutes, the battery should be removed and checked by a qualified Nickel-Cadmium Battery shop.

PERFORMANCE - No change

Approved:



for
Chester A. Rembleske
Beech Aircraft Corporation
DOA CE-2

FAA Approved
October, 1976

P/N 96-590010-21

REG. NO. _____

SER. NO. _____

Page 1 of 1
FAA APPROVED
Date 4/23/71
REVISED 8/30/73
REVISED 10/29/75
REVISED 3/25/76

HARTZELL PROPELLER, INC.
350 WASHINGTON AVENUE
PIQUA, OHIO
FAA APPROVED AIRPLANE FLIGHT MANUAL SUPPLEMENT
FOR
BEECH MODELS 58 & 58A LANDPLANES
WITH HARTZELL PROPELLERS PER STC SA773CE

THIS DOCUMENT MUST BE KEPT IN THE AIRPLANE AT ALL TIMES WHEN HARTZELL PROPELLERS ARE INSTALLED PER STC SA773CE. INFORMATION CONTAINED HEREIN SUPPLEMENTS OR SUPERSEDES CORRESPONDING INFORMATION IN PLACARDS, AIRCRAFT SPECIFICATIONS, OR BASIC AIRPLANE FLIGHT MANUAL (IF APPLICABLE).

I. LIMITATIONS

C. PROPELLERS:

1. Two Hartzell constant-speed, full feathering, three-bladed propellers (87 lbs. @ Station +14.75; 91 lbs. for propellers designated by "U")
Hubs: PHC-J3YF-2 or PHC-J3YF-2F or PHC-J3YF-2UF or PHC-J3YF-2U
Blades: C7663-2R or FC7663-2R
Spinner: C-3567 or C-3567-1 (or C-3567-4P with air conditioning)
Governor: D210439 or 210662
Pitch Settings at 30 inch station: Low 13.0° - High 82.0°
Diameter: Not over 76 inches, not under 74 inches

OR

2. Two Hartzell constant-speed, full feathering, two-bladed propellers (69 lbs. @ Station +14.75; 73 lbs. for propellers designated by "U")
Hubs: BHC-J2YF-2C or BHC-J2YF-2CF or BHC-J2YF-2CUF or BHC-J2YF-2CU
Blades: C8475-6 or FC8475-6
Spinner: C-2285 or C-2285-1 or C-2285-6 (or C-2285-4 or C-2285-5 with air conditioning)
Governor: D210439 or 210662
Pitch Settings at 30 inch station: Low 14.5° - High 80.0°
Diameter: Not over 78 inches, not under 76 inches

II. PROCEDURES

B. EMERGENCY PROCEDURES:

1. Single-engine procedures and speeds are identical to those in the basic Airplane Flight Manual.

III. PERFORMANCE

No Change.

FAA APPROVED

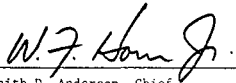
for Keith D. Anderson, Chief
Engineering & Manufacturing
Great Lakes Region
Des Plaines, Illinois

**BEEHCRAFT BARONS
E55, E55A, 58, 58A LANDPLANES**

**PILOT'S OPERATING HANDBOOK AND
FAA APPROVED AIRPLANE FLIGHT MANUAL
SUPPLEMENT**

for the

100-AMP ALTERNATOR SYSTEM

GENERAL

This document is to be attached to the Pilot's Operating Handbook and FAA Approved Airplane Flight Manual when the airplane is equipped with two 100-Amp Alternators, which have been installed in accordance with BEEHCRAFT drawings by Beech Kit 58-3001.

LIMITATIONS

Loadmeters indicate individual alternator output reading in percentage of load on system. Meter reading of 1.0 is a load of 100 amperes.

ENGINE INSTRUMENT MARKINGS

Loadmeter

Do not exceed (Red Radial)85

NORMAL PROCEDURES - No Change

**FAA Approved
October, 1976
P/N 96-590010-23**

1 of 3

EMERGENCY PROCEDURES

EXCESSIVE LOADMETER INDICATION (over .85 Red Radial)

1. Battery Switch - OFF (Monitor Loadmeter)

If loadmeter still indicates above .85 Red Radial:

2. Non-Essential Loads - OFF
3. Battery Switch - ON

ILLUMINATION OF ALTERNATOR OUT LIGHT

In the event of the illumination of a single ALTERNATOR OUT light:

1. Check the respective loadmeter for load indication
 - a. No Load - TURN OFF AFFECTED ALTERNATOR
 - b. Remaining Loadmeter - MONITOR (load must not exceed limitation)

In the event of the illumination of both ALTERNATOR OUT lights:

1. Check loadmeters for load indication
 - a. No load indicates failure of regulators

2. If condition indicates malfunction of both alternator circuits
 - a. Both ALT Switches - OFF
 - b. Non-Essential Loads - OFF (since only battery power will be available)

Approved:

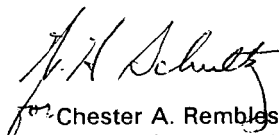
for Chester A. Rembleske
Beech Aircraft Corporation
DOA CE-2

**BEECHCRAFT BARON 95-B55, 95-B55A, E55, E55A,
58, 58A, 58P, 58PA, 58TC, and 58TCA LANDPLANES**

**PILOT'S OPERATING HANDBOOK AND
FAA APPROVED AIRPLANE FLIGHT MANUAL SUPPLEMENT
for the**

BENDIX NP-2041A NAV COMPUTER PROGRAMMER

GENERAL

The information in this supplement is FAA-approved material and must be attached to the Pilot's Operating Handbook and FAA Approved Airplane Flight Manual when the airplane has been modified by installation of the Bendix NCP-2040 Nav Programmer System with the NP-2041A Nav Computer Programmer in accordance with Beech-approved data.

The information in this supplement supersedes or adds to the basic Pilot's Operating Handbook and FAA Approved Airplane Flight Manual only as set forth within this document. Users of the manual are advised always to refer to the supplement for possibly superseding information and placarding applicable to operation of the airplane.

LIMITATIONS

1. The Area Navigation Function may not be used as a primary navigation system under IFR conditions, except on approved approach procedures, approved area navigation airways, and random area navigation routes when approved by Air Traffic Control.
2. The maximum distance for waypoint location is 199.9 nautical miles from the station.

FAA Approved
Revised: January, 1980
P/N 96-590011-21

3. The Area Navigation Function can only be used with collocated facilities (VOR and DME signals originate from the same geographical location).

EMERGENCY PROCEDURES

1. Dashed BRG and/or DST display windows imply an external (NAV or DME) flag input. If either signal is lost, do not use the NP-2041A for area navigation.

The source of the external flag can be determined by setting the mode selector to VOR/LOC and observing the indications. A dashed BRG display indicates either a loss of NAV signal, or an ILS frequency is selected. A dashed DST display indicates a loss of DME signal. If neither display is dashed, the NAV and DME are not paired properly.

CAUTION

The DME may unlock due to loss of signal with certain combinations of distance from the station, altitude, and attitude.

2. If the system automatically displays a lamp test, an internal failure in the NP-2041A is indicated. If a failure is observed, do not use the NP-2041A for area navigation.
3. A dashed EL display window indicates an altimeter flag and implies loss of slant range correction.

NORMAL PROCEDURES

1. SPK VOL (& ON/OFF) Switch - ON (CNA 2010 System)
2. DME - ON

FAA Approved
Revised: January, 1980
P/N 96-590011-21

3. DME (Frequency Pairing) Switch - N1 (CNA 2010 System)
4. KBD/NAV 1/COM 1 Selector - KBD (CNA 2010 System)

NOTE

The NP-2041A NAV Computer Programmer is now coupled to the CNA 2010 NAV/COM System. Only the no. 1 VOR and DME receivers supply information to the NP-2041A NAV Computer Programmer.

5. OFF/VOR-LOC/TEST/RNAV/APR Selector - VOR/LOC (NP-2041A System)
6. SBY/ACT/BRG-DST/KTS-TTS Selector - SBY (NP-2041A System)
7. SBY/WPT Key - Depress
8. No. 1 Key - Depress (Note the no. 1 indicated in the SBY display window) Program Standby Waypoint Number 1 Parameters in any sequence. Press ENTER key after each parameter programmed.

NOTE

Pressing any one of the **FREQ**, **BRG**, **DST**, **EL**, or **CRS** keys causes a flashing dot to appear in the associated display window. A flashing dot indicates the parameter that is being addressed. As number keys corresponding to data are pressed, the numbers appear in the addressed window. If valid data is entered into the window, the flashing dot will extinguish when the **ENTER** key is pressed. If invalid data is entered in the window, the data will be rejected when the **ENTER** key is pressed. The window will revert to a flashing dot which indicates data should be reentered.

9. VALID DATA LIMITS:

NAV Frequency	108.00 to 117.95 (.05 steps)
COM Frequency	118.00 to 135.97 (.025 steps)
BRG	000.0 to 359.9
DST	0.0 to 199.9
EL	00 to 99 (100-ft increments)
CRS	000 to 359

- a. STATION FREQUENCY - Press **FREQ** key; press number keys corresponding to the frequency of the VOR station; and press the **ENTER** key.
- b. WAYPOINT BEARING - Press **BRG** key; press number keys corresponding to the waypoint bearing; and press the **ENTER** key.
- c. WAYPOINT DISTANCE - Press **DIST** Key; press number keys corresponding to waypoint distance; and press the **ENTER** key.
- d. STATION ELEVATION - Press **EL** key; press number keys corresponding to the station elevation in hundreds of feet; and press the **ENTER** key.
- e. INBOUND AND OUTBOUND COURSE - Press **CRS** key; press number keys corresponding to the desired inbound or outbound course (depending upon whether **IN** or **OUT** annunciator lamp is illuminated); and press the **ENTER** key.

Press **CRS XFR** key; **IN/OUT** annunciator lamps will switch. Press **CRS** key, press number keys corresponding to the desired inbound or outbound course (as annunciated); and press the **ENTER** key.

10. Repeat Steps 6 and 7 for any (or all) of the remaining waypoints.

FAA Approved
Revised: January, 1980
P/N 96-590011-21

11. Press SBY/WPT key; press number key corresponding to the waypoint desired to be recalled from memory; and verify data.
12. Set the display selector to BRG/DST.
13. Press the WPT XFR key to transfer the standby waypoint to active.
14. With the mode selector set to VOR/LOC, the following data is displayed:
 - a. DISPLAY SELECTOR SET TO BRG/DST - Bearing and distance to the selected VOR/DME station are displayed.
 - b. DISPLAY SELECTOR SET TO KTS/TTS - Ground speed in knots and time-to-station are displayed in minutes.
 - c. HSI - The HSI presents unprocessed information with conventional angular sensitivity, i.e., full scale deviation equals 10 degrees off course.
 - d. DISPLAY SELECTOR SET TO SBY - Data stored for standby waypoint (number appearing in SBY window) is displayed, and can be altered as desired.
 - e. DISPLAY SELECTOR SET TO ACT - Data stored for active waypoint (number in ACT display window) is displayed, and can be altered as desired.
15. With the mode selector set to RNAV, the following data is displayed:
 - a. DISPLAY SELECTOR SET TO BRG/DST - Bearing and distance to the selected waypoint are displayed.

- b. DISPLAY SELECTOR SET TO KTS/TTS - Ground speed in knots and time-to-waypoint in minutes are displayed.
- c. HSI - The HSI presents RNAV information with constant deviation, i.e., full scale deviation represents 5 nautical miles off course out to a distance of 100 nautical miles. Beyond 100 nautical miles, full scale deviation represents 3 degrees off course.
- d. DISPLAY SELECTOR SET TO SBY - Data stored for standby waypoint (number appearing in SBY window) is displayed, and can be altered as desired.
- e. DISPLAY SELECTOR SET TO ACT - Data stored for active waypoint (number appearing in ACT window) is displayed, but cannot be altered.

NOTE

Provided the KBD/NAV 1/COM 1 selector on the COM/NAV unit is set to KBD, the NAV receiver and DME will be automatically tuned to the frequency stored for the active waypoint. The stored inbound course will be displayed in the CRS window for 30 seconds to allow the CRS control (OBS) on the IN-831 HSI to be set to that course. After the waypoint has been passed, the CRS XFR key can be pressed to recall the out-bound course which will appear for 30 seconds to allow the CRS to be reset.

FAA Approved
Revised: January, 1980
P/N 96-590011-21

16. With the mode selector set to APR, the displays are the same as RNAV, except full scale deviation represents 1.25 nautical miles off course out to 25 nautical miles. Beyond 25 nautical miles, full scale deviation represents 3 degrees off course.

17. A system self-test can be performed by placing the mode selector in the TEST position. Valid indications are as follows:
 - A. NP-2041A
 - a. FREQ, FL and CRS windows are dashed.
 - b. BRG window equals 180.0 ± 0.5 degrees.
 - c. DST window equals 30.0 nautical miles.

 - B. HSI
 - a. The needle should center at 0 ± 2 degrees TO.
 - b. Rotate the CRS control on the HSI for a 10 ± 2 degrees course. The horizontal deviation bar will go to full scale deviation to the right.
 - c. Rotate the CRS control on the HSI for a 350 ± 2 degrees course. The horizontal deviation bar will go to full scale deviation to the left.
 - d. Provided the system performs as described, the RNAV system should be considered fully operational.

18. A lamp test can be performed by placing the SQ/OFF/L switch on the COM/NAV unit in the "L" position. Normal

indications are as follows:

- a. Hundred MHz numerals equals 1.
- b. All other numerals equal 8's.
- c. IN, OUT, and keyboard annunciators "ON".

Approved:

Donald H. Peter

For

W. H. Schultz
Beech Aircraft Corporation
DOA CE-2

BEECHCRAFT BARON 58/58A (TH-680, TH-773 and After) and BARON E55/E55A (TE-1084 and After) LAND-PLANES

**PILOT'S OPERATING HANDBOOK AND
FAA APPROVED AIRPLANE FLIGHT MANUAL
SUPPLEMENT**

for the

AIR CONDITIONING SYSTEM

GENERAL

This document is to be attached to the Pilot's Operating Handbook and FAA Approved Airplane Flight Manual when the airplane is equipped with the Air Conditioning System which has been installed in accordance with BEECHCRAFT FAA approved data.

This document supersedes or adds to the Pilot's Operating Handbook and FAA Approved Airplane Flight Manual only where covered in the items contained herein.

LIMITATIONS

The air conditioning system must be off during takeoff.

PROPELLERS

Baron E55/E55A (TE-1084 and after) and Baron 58/58A (TH-680 and TH-773 through TH-1395, except TH-1389): Hartzell BHC-J2YF-2CUF or -2CF (two-blade) or PHC-J3YF-2UF or -2F (three-blade) hubs and C-2285-5P (two-blade) or C-3567-4P (three-blade) spinner assemblies.

Baron 58/58A (TH-1389, TH-1396, and after): McCauley 3AF32C512 (three-blade) hubs and D-5310 spinner assemblies.

FAA Approved
Revised: October, 1983
P/N 58-590000-23

EMERGENCY PROCEDURES

The air conditioning system must be OFF during the following conditions:

- Engine fire on the ground
- Engine fire in flight
- Engine failure after lift-off and in flight
- Air start procedure
- Air conditioning system malfunctioning

NOTE

If air conditioning system circuit breaker trips, do not reset until cause of malfunction has been determined and corrected.

One engine inoperative

WARNING

Climb performance with one engine inoperative is degraded when air conditioning system is operating. The system must be turned OFF in event of engine failure.

NORMAL PROCEDURES

STARTING

Air conditioner may be on as desired after engine start for cabin cooling before takeoff.

BEFORE TAKEOFF

Air conditioning system must be turned off before takeoff. After landing gear is retracted and airplane is clear of all

obstacles, air conditioning system may be turned on as desired.

SHUTDOWN

Turn off air conditioner before engine shutdown.

PERFORMANCE

CRUISE PERFORMANCE

With air conditioner operating, range and airspeed will decrease approximately 3% due to extension of air conditioner air scoop to mid-position. This should be taken into consideration during flight planning.

WEIGHT AND BALANCE/EQUIPMENT LIST - No change.

SYSTEMS DESCRIPTION

COOLING

The refrigerant 12 air conditioning system has a capacity of 14,000 BTU's per hour and consists of forward and aft evaporator modules, compressor in the left engine section, condenser and condenser blower in the left nacelle, and nacelle door to introduce prop blast and ram air for condenser cooling.

Controls consist of a two position switch placarded AIR COND ON-OFF and a three position evaporator blower switch placarded HI-OFF-LO. Both switches are located adjacent to each other on the pilot's subpanel. The evaporator blowers may be turned on independent of the air conditioning system to provide cabin air circulation when the air conditioner is turned off.

FAA Approved
Revised: October, 1983
P/N 58-590000-23

When the air conditioning system is ON (while in flight), the nacelle scoop door opens to the mid-position. If the system is ON while on the ground, with engines operating, the nacelle scoop door will open fully and the condenser blower will operate to assist air flow through the condenser during ground operation. The blower goes off when the system is off. After the air passes through the condenser, it is ducted overboard through the opening in the aft nacelle.

One evaporator is mounted on the aft cabin bulkhead and distributes air to the overhead cabin air outlets. The other evaporator is located in the nose baggage compartment and distributes air to the pilot and copilot outlets.

HANDLING, SERVICING, AND MAINTENANCE

Check air conditioner evaporator module filter, forward of closure bulkhead, every 100 hours; replace filter, if required.

Approved:



W. H. Schultz
Beech Aircraft Corporation
DOA CE-2

**BEECHCRAFT BARON MODELS 95-B55, 95-B55A, E55,
E55A, 58, 58A, 58P, 58PA, 58TC, 58TCA**

LANDPLANES

**PILOT'S OPERATING HANDBOOK
and
FAA APPROVED AIRPLANE FLIGHT MANUAL
SUPPLEMENT
for the**

AIRDATA AD611/D AREA NAVIGATION

GENERAL

The information in this supplement is FAA-approved material and must be attached to the FAA Approved Airplane Flight Manual when the airplane has been modified by installation of the AirData AD611/D Area Navigation System in accordance with Beech-approved data.

The information in this supplement supersedes or adds to the basic FAA Approved Airplane Flight Manual only as set forth within this document. Users of the manual are advised always to refer to the supplement for possibly superseding information and placarding applicable to operation of the airplane.

The RNAV function of the AirData AD611/D system performs a vector computation that results in a visual display of the magnetic bearing and distance to or from a selected waypoint. The computer, in effect, moves the selected reference facility (VORTAC or colocated VOR/DME facility) to a different location called a waypoint. The waypoint, which is expressed in terms of nautical miles along a selected radial from the VORTAC, is programmed into the system on the Manual Waypoint Setter.

**FAA Approved
Issued: June 21, 1977
P/N 58-590000-25**

Steering guidance is presented as a left/right display on the Horizontal Situation Indicator (HSI). The display format differs from the conventional VOR course deviation of ± 10 degrees called "angular course deviation." Rather, course deviation is presented in nautical miles from the course centerline. This feature, referred to as "linear course deviation", provides for a constant course width irrespective of the distance to the waypoint. Two levels of sensitivity are available for area navigation. The enroute sensitivity, available when the APPR pushbutton on the system's range indicator is not activated, provides a constant course width of ± 5 nautical miles. Approach sensitivity, available with the APPR pushbutton depressed, provides a constant course width of ± 1.25 nautical miles. Approach sensitivity should be used when within 10 nautical miles of the terminal waypoint.

LIMITATIONS

1. The area navigation system may not be used as a primary system under IFR conditions except on approved approach procedures, approved airways, and random area navigation routes when approved by Air Traffic Control.
2. This system can only be used with colocated facilities. (VOR and DME signals originate from same geographical location.)

EMERGENCY PROCEDURES

CAUTION

DME may unlock due to loss of signal with certain combinations of distance from station, altitude and angle of bank.

1. If NAV flag appears while in the enroute mode, check for correct frequency.

FAA Approved
Issued: June 21, 1977
P/N 58-59000-25

2. If VOR or DME equipment is intermittent or lost, utilize other navigation equipment as required.
3. If NAV flag appears during an approach, execute published missed approach and utilize another approved facility.

NORMAL PROCEDURES

The AirData AD611/D system is programmed and operated from a Digital Range/Mode Control Unit, and one or more Waypoint Setter Units. Frequency selection and course display are provided by the standard navigation controls and HSI.

CONTROLS AND DISPLAYS

DIGITAL RANGE/MODE CONTROL UNIT (RNAV)

1. RNAV ON-OFF Pushswitch:

Used to activate and deactivate the RNAV system. It is a push ON/push OFF switch that is backlighted whenever it is in the ON state. When ON, it connects the RNAV computer to the HSI. When OFF, the HSI display presents conventional VOR/LOC information.

2. APPR Pushswitch:

Used to activate or deactivate the RNAV approach mode of operation. This operation increases the sensitivity of the HSI presentation and is used when approaching a waypoint in an approach to landing. The switch is backlighted whenever it is switched ON.

3. Digital Display:

Normally indicates the distance to the waypoint in nauti-

cal miles from present position. The airplane's standard DME distance indicator will continue to display DME distance to the reference VORTAC.

4. BRG Pushbutton:

Used to temporarily cause the digital display to indicate the magnetic bearing from the airplane to the selected waypoint. Valid VOR and DME signals must be received for this function.

5. TEST Pushbutton:

Illuminates the three diagnostic annunciator lights to verify light operation. Temporarily causes the digital display to indicate the waypoint DISTANCE value entered on the active waypoint setter unit. Also, a reference bearing output is sent to the HSI which causes the left/right needle to center when the course selector is set to the RADIAL value entered on the active waypoint setter unit. Depressing both the TEST and BRG buttons simultaneously causes the waypoint RADIAL value entered on the active waypoint setter unit to appear on the digital display.

These tests require at least 10 nautical miles be set into the waypoint DISTANCE and reception of a valid VOR signal.

6. Diagnostic Lights:

Each of the three fault annunciators will flash and the digital display will be blank under the specified conditions.

DTW:Indicates that "distance to waypoint" computation cannot be made. This can be an excessive dis-

tance (over 199.9 NM to waypoint), excessive RADIAL setting (over 359.9 degrees) or a computer malfunction.

VOR: Indicates that computation quality of VOR signal has been lost.

DME: Indicates a loss of DME signal.

WAYPOINT SETTER UNIT (RNAV)

1. RADIAL Thumbwheels:

Set to indicate the bearing from the VOR to the waypoint. The DTW diagnostic annunciator will flash if a RADIAL entry exceeds 359.9 degrees or results in a distance-to-waypoint exceeding 199.9 nautical miles.

2. DISTANCE Thumbwheels:

Set to indicate the distance from the VOR to the waypoint.

3. ACTIVATE Pushbutton:

Depressing white pushbutton, located above the RADIAL thumbwheels, activates that waypoint setter unit, placing its RADIAL and DISTANCE information into the RNAV computer. In systems containing more than one waypoint setter unit, the number 1 is automatically activated when the RNAV ON-OFF switch is selected ON. Any other waypoint setter unit can then be activated by depressing the ACTIVATE pushbutton on the desired waypoint setter unit.

Depressing the ACTIVATE pushbutton also performs a "fast update" function for the RNAV computer each time

it is depressed. Fast update allows current VOR and DME information on aircraft position into the computer without averaging out the errors in these signals. Fast update would be used after channeling a new frequency into the NAV equipment, after regaining DME lock-on, or after changing a thumbwheel setting on an active waypoint setter unit.

4. Waypoint Indicator Light:

Yellow light, located above DISTANCE thumbwheels, illuminates whenever its waypoint setter unit is activated. These lights are numbered when more than one waypoint setter unit is installed.

PREFLIGHT

The preflight check is to test the computation accuracy of the computer and to assure the proper operation of the controls and displays. This procedure should be completed prior to programming for the intended flight.

1. Depress RNAV pushswitch to ON.
2. Set RADIAL thumbwheels to 000.0 degrees.
3. Set DISTANCE thumbwheels to 25.0 NM.
4. Set NAV 1 receiver to VOR or VORTAC within receiving range.
5. Press and hold TEST button. Adjust course control on HSI to produce centered needle with "TO" indication. Check that:
 - a. Digital display indicates 25.0 ± 1 NM.
 - b. The course setting is 000 ± 2 degrees.

FAA Approved
Issued: June 21, 1977
P/N 58-590000-25

6. Press and hold BRG and TEST buttons. Check that:
 - a. Digital display indicates 0 ± 1 degree.
7. Release BRG and TEST buttons.

NOTE

If any of the preflight tests are not within the prescribed tolerances, the RNAV system will not meet the required standards of accuracy. Corrective adjustments or maintenance is required. This procedure does not test the DME.

PROGRAMMING

1. Waypoint Definition - Determine in terms of RADIAL and DISTANCE (NM) from a specific VORTAC.

NOTE

The maximum allowable RADIAL setting is 359.9 degrees. If a RADIAL of 360.0 degrees is desired, use a value of 000.0 degrees. The maximum allowable DISTANCE setting is 199.9 NM. The maximum allowable range from the airplane to the waypoint is also 199.9 NM. If any of these restrictions are exceeded, select a waypoint that is within these values.

2. Waypoint Setter Unit(s) - SET Thumbwheels (RADIAL & DISTANCE)
3. NAV Receivers (VOR & DME) - ON. Frequency SET.

4. RNAV ON-OFF Pushswitch - ON (switch illuminated)

NOTE

The number 1 waypoint setter unit is automatically selected when the RNAV pushswitch is turned ON.

5. Digital Display - Check to insure that distance to waypoint value appears.
6. HSI Course Control - SET to desired magnetic course.

ENROUTE

Using the AirData AD611/D₁ system enroute corresponds to flying VOR airways, except navigation is now to or from waypoints. The waypoint parameters (radial and distance) in effect "move" the VORTAC. Once this is accomplished, the horizontal situation indicator and AD611/D digital range indicator will provide guidance to the waypoint similar to conventional VOR/DME navigation. The only notable difference is the course deviation needle on the HSI will maintain a constant sensitivity of ± 5 nautical miles irrespective of the distance to the waypoint. The range indicator will count down to approximately 0.2 nautical mile when, upon reaching the waypoint, the TO flag will change to FROM.

When the next waypoint is required for navigation, depress the ACTIVATE pushbutton on the next waypoint setter unit in sequence, confirm the proper VORTAC frequency is set, and set the desired magnetic course on the horizontal situation indicator.

NOTE

If an ILS frequency is selected on NAV 1 while in

FAA Approved
Issued: June 21, 1977
P/N 58-590000-25

an RNAV mode, the NAV flag will appear on the horizontal situation indicator and the VOR diagnostic light will flash. The RNAV must be selected OFF for ILS or conventional VOR operation (except for Approach Range Monitor operation).

APPROACH

Using the AirData AD611/D system for an approach is similar to making a localizer approach. However, the system is using VOR and DME information and the MDA will be higher than when conducting a precision approach. Insert the waypoint parameters from the approach chart into the waypoint setter units. These parameters must be taken from an approved RNAV approach procedure for IFR operations. Activate the approach mode by depressing the APPR pushswitch. This will increase the horizontal situation indicator navigation sensitivity to a ± 1.25 nautical miles course width. For smoother operation, the computed distance to the waypoint should not exceed 30 nautical miles while in the approach mode.

Set the appropriate inbound course to each waypoint in turn and depress the ACTIVATE pushbutton on the appropriate waypoint setter unit to establish the next waypoint. If landing cannot be made upon reaching the MAP, follow the missed approach procedure outlined on the approved plate.

APPROACH RANGE MONITOR

The Approach Range Monitor feature provides for the separation of the RNAV computed range to a waypoint from the steering guidance of the pilot's horizontal situation indicator. Selecting the Approach Range Monitor switch to the RANGE MONITOR position will connect the RNAV com-

puter to the NAV 2 receiver. The pilot's horizontal situation indicator will be retained on the NAV 1 receiver.

On an ILS approach, for example, it is desirable to know distance to the outer marker and then to the runway threshold. By selecting RANGE MONITOR and setting the appropriate NAV 2 frequency and waypoint parameters in the waypoint setter unit, the distance to the desired fix will be continuously displayed while ILS steering guidance on the horizontal situation indicator will be conventional. The result is the ability to fly a localizer or full ILS steering situation while retaining RNAV computed distance to a selected fix.

CAUTION

It is imperative the Approach Range Monitor switch be placed in the NORMAL position during RNAV operations. If left in the RANGE MONITOR position, the range display will be based on the NAV 2 frequency and waypoint setter unit parameters, and the pilots horizontal situation indicator will display conventional VOR steering based on the selected NAV 1 frequency.

PERFORMANCE - No change.

Approved:

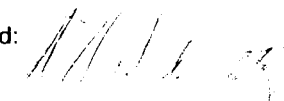

Chester A. Rembleske
Beech Aircraft Corporation
DOA CE-2

**BEECHCRAFT BARON 95-B55, 95-B55A, E55, E55A, 58,
58A, 58P, 58PA, 58TC, and 58TCA LANDPLANES**

**PILOT'S OPERATING HANDBOOK AND
FAA APPROVED
AIRPLANE FLIGHT MANUAL SUPPLEMENT**

for the

COLLINS ANS-351 AREA NAVIGATION SYSTEM

GENERAL

The information in this supplement is FAA approved material and must be attached to the *Pilot's Operating Handbook and FAA Approved Airplane Flight Manual* when the airplane has been modified by installation of the Collins ANS-351 Area Navigation System in accordance with Beech FAA Approved Data.

The information in this supplement supersedes or adds to the basic *Pilot's Operating Handbook and FAA Approved Airplane Flight Manual* only as set forth within this document. Users of the manual are advised always to refer to the supplement for possibly superseding information and placarding applicable to operation of the airplane.

LIMITATIONS

1. The Area Navigation function may not be used as a primary system under IFR conditions except on approved approach procedures, approved area navigation airways, and random area navigation routes when approved by Air Traffic Control.

**FAA Approved
Issued: November 16, 1977
P/N 106-590000-15**

2. The Area Navigation function can only be used with co-located facilities. (VOR and DME signals originate from the same geographical location.)
3. The maximum distance for waypoint location is 199 nautical miles from the VOR/DME facility.
4. Approach mode should be restricted to distances of 50 nautical miles or less from the waypoint in use.

EMERGENCY PROCEDURES

CAUTION

DME may unlock due to loss of signal with certain combinations of distance from station, altitude and angle of bank.

1. If NAV flag appears while in the enroute mode, check for correct frequency.
2. If VOR or DME equipment is intermittent or lost, utilize other navigation equipment as required.
3. If NAV flag appears during an approach, execute published missed approach and utilize another approved facility.

NORMAL PROCEDURES

1. NAV receivers - ON
2. Presetting waypoints on the ground:

FAA Approved
Issued: November 16, 1977
P/N 106-590000-15

NOTE

When power is first applied to the ANS-351 and the system is in the RNAV mode, WPT 1 will be active and waypoint bearing and distance indicators will read zero.

- a. WPT 1 coordinates are set into the ANS-351 using the concentric knobs under the bearing and distance display fields.
 - b. The waypoint selection knob is then rotated to select WPT 2. Note that the waypoint number is blinking, indicating that the waypoint is inactive at this point. WPT 2 bearing and distance definitions are then set into the ANS-351.
 - c. Set up the rest of the desired waypoints as described above. The ANS-351 has memory capacity for 8 waypoints.
 - d. Press the RTN (return) push button to display the active waypoint.
3. Changing waypoints in flight:
- a. Select heading mode on the autopilot if engaged.
 - b. Rotate the waypoint selector until the desired waypoint number and coordinates are displayed.
 - c. Verify that the new waypoint definition is correct by comparing the display to the flight plan.

NORMAL PROCEDURES (Cont.)

- d. Select the desired reference frequency on the associated navigation receiver and positively identify by listening to the "ident" tone.
 - e. Select the desired course on the OBS (Omni Bearing Selector).
 - f. Press the USE button on the ANS-351 and note that the waypoint identification number stops blinking.
 - g. Select the NAV mode on the autopilot after the deviation and distance-to-waypoint indications have stabilized.
4. Presetting waypoints in flight (RNAV mode):

Waypoints may be preset in flight without disturbing the navigational outputs.

- a. Rotate the waypoint selector knob to display the waypoint number to be preset. Note blinking waypoint number.
 - b. Set into the ANS-351 the desired waypoint bearing and distance.
 - c. Press the RTN (return) push button and note that the presently used waypoint is displayed.
5. Presetting waypoint in flight (VOR/LOC modes):

If the system is in VOR or LOC mode the ANS-351 will annunciate these modes on the display.

- a. Rotate the waypoint selector knob and note that the VOR or LOC annunciator is replaced by waypoint number, bearing, and distance. The waypoint number will always be blinking and the USE push button will be inactive.
- b. Preset the waypoint bearing and distances.
- c. Press the RTN (return) push button and observe the annunciation of VOR or LOC on the ANS-351 panel.

PERFORMANCE

No change.

SYSTEM DESCRIPTION

1. Navigation System Mode Control - A four position switch, located on the instrument panel or DME control head, is used to select the navigational mode of operation, either RNAV or VOR.
2. The Collins DME indicator used with the computer in the RNAV mode displays distance to the active waypoint in nautical miles, time to the waypoint in minutes, and all angle ground speed in knots (i.e. the airplane does not have to be on a course directly to a waypoint to display a valid groundspeed). A green annunciator light on the indicator is illuminated any time the system is in the RNAV mode and power is applied to the NAV receiver.

SYSTEM DESCRIPTION (Cont.)

After initiating the RNAV mode, always observe the ground speed over a period of 2 minutes or more to ensure that the indication has reached a steady-state value.

3. ANS-351 Area Navigation Computer
 - a. Collins Mode Control (ENR/APPR) - Use of this control allows selection of either ENR (enroute) or APPR (approach) modes of operation. In the enroute mode the course deviation is 5 nautical miles full scale. In the approach mode the course deviation is 1.25 nautical miles full scale deflection of the CDI, (Course Deviation Indicator).
 - b. Waypoint Selector (WPT) - Sequences display waypoints from 1 through 8. Winking waypoint number indicates nonactive waypoints; steadily on waypoint number indicates the active waypoint.
 - c. Radial Selector - Two concentric knobs can be used to set radial information into the display. Knobs control information as follows:
 - Large knob: Changes display in 10-degree increments.
 - Small knob, pushed in: Changes display in 1-degree increments.
 - Small knob, pulled out: Changes display in 0.1-degree increments.

FAA Approved
Issued: November 16, 1977
P/N 106-590000-15

- d. Distance Selector - Two concentric control knobs can be used to set distance information in nautical miles into the display.

Knobs control information as follows:

Large knob: Changes the display in 10-nautical mile increments.

Small knob, pushed in: Changes the display in 1-nautical mile increments.

Small knob, pulled out: Changes the display in 0.1-nautical mile increments from 00.0 through 100 miles. Beyond 100 NM, changes the display in 1-mile increments.

- e. Return Button (RTN) - Pressing RTN returns the display to the active waypoint when a nonactive waypoint is currently being displayed.
- f. Use Button (USE) - Pressing the USE button converts the waypoint being displayed into the active waypoint.
- g. Check Button (CHK) - Pressing the CHK button causes normal slant range DME distance to the VOR/DME station to be presented on the DME indicator. The WPT annunciator on the DME indicator will extinguish during this time. If TO or FROM is selected on the Collins NAV receiver, the magnetic bearing to or from

SYSTEM DESCRIPTION (Cont.)

the VOR/DME station will be displayed. The WPT annunciator light on the NAV receiver will extinguish during the time the CHK button is held down. If an RMI is installed, and is compatible with the ANS-351, pressing the check button will cause the bearing pointer to indicate the bearing to the active VOR station. RNAV computation, CDI deviation, TO/FROM display, and autopilot tracking of RNAV path remain unaffected. The check button is spring loaded to prevent prolonged actuation.

- h. Ambient Light Sensor - Automatically adjusts display lighting intensity as a function of cockpit ambient light.
4. Collins Navigation Receiver (NAV).
- a. OFF - Controls power to the NAV receiver and to the Area Navigation Computer.
 - b. FREQ - Allows the selection of VOR and Localizer frequencies.
 - c. TO - Displays airplane magnetic bearing to the VOR station in the normal mode and airplane magnetic bearing to the waypoint in the RNAV mode.
 - d. FROM - Displays airplane magnetic bearing from the VOR station in the normal mode, and airplane bearing from the waypoint in the RNAV mode.
 - e. WPT Annunciator - Light is illuminated any time the NAV receiver is on, the RNAV mode

FAA Approved

Issued: November 16, 1977

P/N 106-590000-15

is selected, and CHK button is not depressed.

- f. Ambient Light Sensor - Automatically adjusts display lighting intensity as a function of cockpit ambient light.
5. CDI (Course Deviation Indicator)
- a. Operation of the CDI in the RNAV mode differs from the operation in the VOR mode as follows:
 1. Indicator movement represents a linear deviation from the selected course.
 2. In the enroute mode, full scale deviation is 5 NM. In the approach mode, the full scale deflection is 1.25 NM.
 3. An annunciator light on the instrument panel illuminates any time power is applied to the NAV receivers and the system is in the RNAV mode.
6. RMI Bearing

An output is provided by the ANS-351 that allows an RMI with built-in NAV converter to display bearing to or from the waypoint while operating in the RNAV mode. (NOTE: (An RMI may or may not be installed to work in conjunction with the RNAV computer).

Approved:

for 
Chester A. Rembleske
Beech Aircraft Corporation
DOA CE-2

FAA Approved
Issued: November 16, 1977
P/N 106-590000-15

**BEECHCRAFT 95-B55, 95-B55A, E55, E55A
58, 58A, 58P, 58PA, 58TC and 58TCA
LANDPLANES**

PILOT'S OPERATING HANDBOOK

and

FAA APPROVED AIRPLANE FLIGHT MANUAL

SUPPLEMENT

FOR THE

AIRDATA AD-511/AD-511G AREA NAVIGATION SYSTEM

GENERAL

The information in this supplement is FAA-Approved material and must be attached to the FAA Approved Airplane Flight Manual when the airplane has been modified by installation of the AirData AD-511/AD-511G Area Navigation System in accordance with Beech-approved data.

The information in this supplement supersedes or adds to the basic FAA-Approved Airplane Flight Manual only as set forth within this document. Users of the manual are advised always to refer to the supplement for possibly superseding information and/or placarding applicable to operation of the airplane.

The RNAV function of the AirData AD-511/AD-511G system performs a vector computation that results in a digital display of the magnetic bearing and range in nautical miles to or from a selected waypoint. On the AD-511G only, groundspeed and time-to-station read-outs also appear

FAA Approved
Revised: July, 1979
P/N 58-590000-27

1 of 10

when the KTS/MIN pushbutton is depressed. The computer, in effect, moves the selected reference facility (colocated VOR/DME facility) to a different location called a waypoint. The waypoint, which is expressed in terms of nautical miles along a selected radial from the reference facility, is programmed with the thumbwheels on the AD-511/AD-511G. RNAV steering can be accomplished by flying the magnetic heading presented in the BEARING digital display or by reference to the CDI/HSI with Steering Adapter (51DSA or 51ASA) installed. Note that the 51ASA provides "angle" steering where full scale needle deflection is $\pm 10^\circ$ as in VOR tracking, whereas with the 51DSA installed the CDI/HSI displays "linear" needle deflection having full scale needle deflection of ± 5 NM. If the 51DSA Steering Adapter is installed, there may be a switch located on the airplane panel to select RNAV Enroute/Approach mode of steering. For enroute operations the switch is left in the Enroute position which provides full scale needle deflection of ± 5 NM. During RNAV instrument approach operations the Approach position offers more sensitive needle deflection of ± 1.25 NM full scale. The AD-511 is designed to the standard that "OFF is OUT". This means that when the RNAV is OFF, the basic VOR and LOC functions of the navigational system will remain operative.

LIMITATIONS

1. The area navigation system may not be used as a primary navigational system under IFR conditions except on approved approach procedures, approved airways, and random area navigation routes when approved by Air Traffic Control.
2. This system can only be used with colocated VOR/DME navigational facilities (VOR and DME signals originate from the same geographical location).
3. The Approach mode of the AD-511/AD-511G with the 51DSA Steering Adapter (if installed) shall be limited to

FAA Approved
Revised: July, 1979
P/N 58-590000-27

approach operations with ground speeds under 180 knots at a distance less than 25 nautical miles from the waypoint.

EMERGENCY PROCEDURES

CAUTION

DME may unlock due to loss of signal with certain combinations of distance from station, altitude and angle of bank.

1. If NAV flag appears while in the Enroute mode, check for correct navigational frequency.
2. If VOR or DME equipment is intermittent or lost, utilize other navigational equipment as required.
3. If FLAG mode appears during an approach, execute published missed approach and utilize another approved navigational facility or approach procedure.

NORMAL PROCEDURES

The AirData AD-511/AD-511G system is programmed and operated through a central control unit with optional remote steering commands through a CDI/HSI (if installed). Frequency selection is provided by the standard navigational controls.

PREFLIGHT

The preflight check is to test the computation accuracy of the computer and to assure the proper operation of the controls and displays. This procedure should be completed

prior to programming for the intended flight.

1. Depress RNAV ON-OFF pushbutton to ON. The left WPT light should illuminate indicating that the left waypoint is active.
2. Set left WPT RADIAL thumbwheels to 000.0 degrees.
3. Set left WPT DISTANCE thumbwheels to 26.0 NM or less.
4. Set active NAV receiver to appropriate navigational facility (colocated VOR/DME facility) within range.
5. Press and hold TEST pushbutton. If properly calibrated, the BEARING and RANGE NM digital displays should read the active waypoint RADIAL and DISTANCE as dialed into the left waypoint thumbwheels.

NOTE

On the CDI/HSI indicator, the left/right needle will center "TO" when the OBS setting is at the value of the RADIAL as entered into the left waypoint thumbwheels.

PROGRAMMING

1. Waypoint Definition - DETERMINE in terms of RADIAL and DISTANCE (NM) from a specific reference facility (colocated VOR/DME facility).

NOTE

The maximum allowable RADIAL setting is 359.9 degrees. If a RADIAL of 360.0 degrees is desired, use a value of 000.0 degrees. The maximum allowable DISTANCE setting is 199.9

FAA Approved
Revised: July, 1979
P/N 58-590000-27

NM. The maximum allowable RANGE NM from the airplane to the waypoint is also 199.9 NM. If any of these restrictions are exceeded, select a waypoint that is within these values.

2. Waypoint - SET active waypoint thumbwheels (RADIAL and DISTANCE).
3. Navigation Receiver (NAV 1) - TUNE and IDENTIFY.
4. RNAV ON-OFF Pushbutton - ON (switch illuminated).

NOTE

The No. 1 (left) waypoint is automatically selected when the RNAV is turned ON. The No. 1 WPT light should be illuminated.

5. Digital Displays - CHECK to ensure that magnetic heading (BEARING) and distance (RANGE NM) to the waypoint appear.
6. CDI/HSI - SET to desired magnetic course.

ENROUTE

Using the AirData AD-511/AD-511G system enroute corresponds to flying VOR airways, except navigation is now to or from waypoints.

1. Set NAV receiver and AD-511/AD-511G control unit as shown in the PROGRAMMING section for the first two waypoints on the flight plan route.
2. Set the first waypoint.
3. At station passage, select succeeding waypoints.

NOTE

At station passage, the RANGE NM digital display will count down to approximately 0.2 NM (depending on altitude) and the TO/FROM flag on the CDI/HSI will switch from "TO" to "FROM".

APPROACH

Using the AD-511/AD-511G for an approach is similar to making a localizer approach. However, the system is using VOR and DME information and the MDA will be higher than when conducting a precision approach.

1. Set NAV receiver and AD-511/AD-511G control unit as shown in the PROGRAMMING section for the approach.
2. Activate the approach mode by selecting the APPR position on the ENR/APPR switch at the Final Approach Fix.

NOTE

The CDI/HSI needle sensitivity will be increased to ± 1.25 NM cruise width (.25 NM/DOT) with the 51DSA steering system.

3. Set the appropriate inbound course to each waypoint in turn and depress the appropriate WPT pushbutton to activate the desired waypoint.
4. If landing cannot be made upon reaching the Missed Approach Point (MAP), execute the missed approach procedure as directed.

FAA Approved
Revised: July, 1979
P/N 58-59000-27

RANGE MONITORING

The Range Monitoring configuration provides for the separation of the RNAV-computed RANGE NM to a waypoint from the steering guidance presented on the CDI/HSI indicator.

Range monitoring can be accomplished by channeling the NAV 1 receiver into the CDI/HSI indicator and selecting RANGE MONITOR on the NAV 1/RANGE MONITOR switch (if installed) or NAV 2 on the DME selector control.

The CDI/HSI will display NAV 1 navigational information and the AD-511 will display BEARING and RANGE NM digital displays to the waypoint as supplied by the NAV 2/DME navigational information.

PERFORMANCE - No change.

WEIGHT AND BALANCE - No change.

SYSTEMS DESCRIPTION

The AirData AD-511/AD-511G is a basic Area Navigation Computer with two programmable waypoints. The VOR and DME equipment in the airplane provides information to the computer on airplane position relative to the reference facility (colocated VOR/DME facility). The waypoint thumbwheels are used to insert the waypoint parameters (RADIAL and DISTANCE) into the computer. The computer then calculates the magnetic bearing (BEARING digital display) and distance (RANGE NM digital display) from the airplane to the waypoint repeatedly so as to provide continuous steering information to the waypoint. On the AD-511G the computer also calculates ground speed and time-to-waypoint which are displayed in place of BEARING and

FAA Approved
Revised: July, 1979
P/N 58-590000-27

RANGE NM when the KTS/MIN pushbutton is depressed. Straight line paths to the waypoints, up to 200 nautical miles distance, can be flown by reference to the BEARING digital display (or CDI/HSI) and RANGE NM digital display. Waypoint data can be precisely dialed into the thumbwheels to 0.1 and 0.1 NM resolution.

CONTROLS AND DISPLAYS

1. RNAV ON-OFF Pushbutton:

Used to activate and deactivate the RNAV system. It is a push ON/push OFF switch that is backlit when it is ON. When ON, it connects the RNAV computer to the CDI/HSI. When OFF, the CDI/HSI display presents conventional VOR/LOC information.

2. RADIAL Thumbwheels:

Set to indicate the radial from the VOR to the waypoint. A FLAG condition will exist if excess RADIAL data is entered.

3. DISTANCE Thumbwheels:

Set to indicate the distance from the VOR to the waypoint. A FLAG condition will exist if the resultant RANGE NM calculation is in excess of 199 NM.

4. BEARING Digital Display:

Normally indicates the magnetic bearing from the airplane to the selected waypoint. Valid VOR and DME signals must be received for this function. When the VOR/DME momentary switch is depressed, the VOR radial from the VOR to the airplane will appear in the BEARING Digital Display. On the AD-511G, when the KTS/MIN pushbutton is depressed the airplane ground speed will appear in the BEARING Digital Display.

5. RANGE NM Digital Display:

Normally indicates the distance in nautical miles to the waypoint from the present position. The airplane's DME distance indicator will continue to display the

FAA Approved
Revised: July, 1979
P/N 58-590000-27

DME distance to the reference facility. When the VOR/DME momentary switch is depressed, the distance in nautical miles from the airplane to the reference facility will appear in the RANGE NM Digital Display. On the AD-511G, when the KTS/MIN pushbutton is depressed the Time-To Waypoint read-out will appear in the RANGE NM Digital Display.

6. TEST Pushbutton:
When depressed, proper calibration of the RNAV circuits may be checked. If the computer is properly calibrated, the BEARING and RANGE NM digital displays should read the active waypoint RADIAL and DISTANCE as dialed into the active waypoint thumbwheels. Also the CDI/HSI left/right needle will center "TO" when the OBS setting is at the value of the RADIAL entered into the active waypoint thumbwheels.
7. VOR/DME Pushbutton:
When depressed, the VOR radial from the reference facility to the airplane will appear in the BEARING digital display. The distance in nautical miles from the airplane to the reference facility will appear in the RANGE NM digital display.
8. Waypoint (WPT) Pushbuttons:
When the RNAV unit is turned ON, the No. 1 (left) WPT light will always illuminate first. This means that waypoint data on the left side thumbwheels is active. Depressing the No. 2 (right) WPT pushbutton causes the No. 2 (right) WPT light to illuminate and activates the right side thumbwheel data.
9. NAV 1/NAV 2 RNAV Select Switch (if installed):
Used to select VOR receiver No. 1 or No. 2 as the data source for the RNAV.
10. Enroute/Approach Switch (ENR/APPR) (if installed):
Installations having the 51DSA Steering Adapter installed may also have an RNAV Enroute/Approach switch located on the airplane instrument panel. This switch changes the RNAV steering full scale needle

sensitivity from ± 5 NM for Enroute to ± 1.25 NM for RNAV Approach operations. This switch is generally left in the Enroute position for all flight operations unless flying an RNAV instrument approach. At this time the switch can be placed in the Approach position for more sensitive steering.

HANDLING, SERVICING AND MAINTENANCE - No change.

Approved:

For 
W. H. Schultz
Beech Aircraft Corporation
DOA CE-2

FAA Approved
Revised: July, 1979
P/N 58-590000-27

P/N 102-590000-45

**BEECHCRAFT BARONS 95-B55, 95-B55A, E55, E55A,
58, 58A, 58TC, 58TCA, 58P, and 58PA
LANDPLANES**

**PILOT'S OPERATING HANDBOOK AND FAA APPROVED
AIRPLANE FLIGHT MANUAL SUPPLEMENT
for the
KING KNC-610 AREA NAVIGATION SYSTEM**

GENERAL

The information in this supplement is FAA-approved material and must be attached to the FAA Approved Airplane Flight Manual when the airplane has been modified by installation of the King KNC-610 Area Navigation System in accordance with Beech-approved data.

The information in this supplement supersedes or adds to the basic FAA Approved Airplane Flight Manual only as set forth within this document. Users of this manual are advised always to refer to the supplement for possibly superseding information and placarding applicable to operation of the airplane.

LIMITATIONS

1. This system shall not be used as a primary system under IFR conditions except on approved approach procedures, approved area navigation airways, and random area navigation routes when approved by Air Traffic Control.
2. This system is to be used only with colocated facilities (VOR and DME signals originate from the same geographical location).

**FAA Approved
November, 1978
P/N 102-590000-45**

EMERGENCY PROCEDURES

CAUTION

DME may unlock due to loss of signal with certain combinations of distance from station, altitude and angle of bank.

1. If NAV flag appears while in the Area Navigation mode, check for correct frequency.
2. If VOR or DME equipment is intermittent or lost, utilize other navigation equipment as required.
3. If NAV flag appears during an approach, execute published missed approach and utilize another approved facility.

NORMAL PROCEDURES

1. VHF NAV - ON
2. DME - ON
3. Mode Selector - SELECT VOR/DME, RNAV or APPR
4. NAV Frequency - SET
5. DME Frequency - SET
6. Waypoint Bearing - SET WAYPOINT RADIAL FROM VORTAC
7. Waypoint Distance - SET WAYPOINT DISTANCE FROM VORTAC
8. OBS control - DESIRED MAGNETIC COURSE
9. Self-Test - ACTUATE (must have VOR reception)

**FAA Approved
November, 1978
P/N 102-590000-45**

PERFORMANCE

No change

Approved:

Donald H. Petto
for

W. H. Schultz
Beech Aircraft Corporation
DOA CE-2

**BEECHCRAFT BARON 95-B55, 95-B55A,
E55, E55A, 58, 58A, 58P, 58PA, 58TC and
58TCA
LANDPLANES**

**PILOT'S OPERATING HANDBOOK AND FAA APPROVED
AIRPLANE FLIGHT MANUAL SUPPLEMENT
for the
KING KNS-80 INTEGRATED NAVIGATION SYSTEM**

GENERAL

The information in this supplement is FAA-approved material and must be attached to the FAA Approved Airplane Flight manual when the airplane has been modified by installation of the King KNS-80 Navigation System in accordance with Beech-approved data.

The information in this supplement supersedes or adds to the basic FAA Approved Airplane Flight Manual only as set forth within this document. Users of this manual are advised always to refer to the supplement for possibly superseding information and placarding applicable to operation of the airplane.

LIMITATIONS

1. The Area Navigation mode may not be used as a primary system under IFR conditions except on approved approach procedures, approved airways, and random area navigation routes when approved by Air Traffic Control.
2. The Area Navigation mode can only be used with colocated facilities (VOR and DME signals originate from the same geographical location).
3. VOR or VOR-PAR modes must be selected when flying directly to or from a VORTAC facility.

**FAA Approved
Issued January, 1979
P/N 58-590000-29**

EMERGENCY PROCEDURES

CAUTION

DME may unlock due to loss of signal with certain combinations of distance from station, altitude and angle of bank.

1. If NAV flag appears while in the Area Navigation mode, check for correct frequency.
2. If VOR or DME equipment is intermittent or lost, utilize other navigation equipment as required.
3. If NAV flag appears during an approach, execute published missed approach and utilize another approved facility.

NORMAL PROCEDURES

PREFLIGHT

AREA NAVIGATION FUNCTIONAL TEST

The following procedure applies only to airports equipped with, or in range of, a colocated VOR/DME station.

1. Place the KNS-80 in VOR mode.
2. Find and record the angle to the VOR station by centering the D-Bar with a TO TO/FROM flag.
3. Program a waypoint radial angle 120° greater than the indicated VOR radial.

FAA Approved
Issued January, 1979
P/N 58-59000-29

4. Program a waypoint distance equal to the indicated DME value.
5. Place the KNS-80 in RNAV ENR.
6. Rotate the OBS until the D-Bar centers with a TO flag.

The KNS-80 distance-to-station should now read a value equal to the DME distance ($\pm .5\text{NM}$) and the indicated selected course should read 60° greater than the recorded VOR angle to station.

PROGRAMMING

Pertinent information (waypoint number, station frequency, waypoint bearing, and waypoint distance) for up to four waypoints is entered into the memory from the control unit. Programming may be completed prior to takeoff or during the flight. Any combination of navigational facilities (RNAV waypoint, VOR/DME, ILS) may be loaded into the computer; however, it is desirable that each facility be numbered and loaded in the sequence it is to be used.

RNAV WAYPOINTS

1. Turn the system on by rotating the ON/OFF switch clockwise.
2. Put waypoint 1 in the DSP window by depressing the DSP button. Push button as many times as necessary to go through the 1-2-3-4-1 sequence to reach "1".
3. Select the waypoint 1 frequency using the data input controls which are the two concentric knobs on the right.
4. Select the waypoint 1 radial by depressing the DATA button. This will cause the radial for the previous waypoint 1

to appear over the annunciation RAD. Select the new radial with the data input controls.

5. Select the waypoint 1 distance by again depressing the DATA button. This will cause the distance for the previous waypoint 1 to appear over the annunciation DST. Select the new distance with the data input controls.

6. This completes the programming for the first waypoint. Follow these procedures for all selected waypoints up to a maximum of four.

CONVENTIONAL VOR

The programming technique for conventional navigation directly toward or away from a VOR facility without a collocated DME is similar to that for RNAV waypoints. Inputting the waypoint number and frequency into the memory is accomplished in the same manner. Since the station has no DME, it cannot be electronically "moved" to a new location (waypoint). Therefore, no values are programmed in the RAD or DST displays.

ILS APPROACH (Front course and Back course)

Programming an ILS approach is accomplished in the same manner as programming conventional VOR.

MISSED APPROACH

If the published missed approach utilizes an RNAV waypoint or VOR facility, it may be entered into the memory any time prior to the approach. This is accomplished in the same manner set forth in CONVENTIONAL VOR and RNAV WAYPOINTS in this section.

INFLIGHT

Preset waypoints may be recalled from memory and put into active use as required.

1. Press the DSP button as required to select the desired waypoint. The preset waypoint frequency will replace the active waypoint frequency on the display. The selected waypoint number will appear (blinking) over the DSP annunciation. This blinking display is to indicate that the frequency displayed is other than the active waypoint. The waypoint radial and distance may also be checked at this time by pressing the DSP button for each.
2. Verify that the data is correct.

NOTE

Revisions to the waypoint data can be programmed at this time by entering the new waypoint parameters.

3. When navigation to the displayed waypoint is desired, press the USE button. The waypoint number will appear above the USE annunciation on the display board and the number above the DSP annunciation will cease blinking. The new waypoint frequency will automatically appear.

NOTE

When "Time To Station" indicates "0" actual time may be anything from 0 to 59 seconds.

RNAV OPERATION

If the system is receiving valid signals from a colocated VOR-LOC facility, it will supply linear deviation information to the Horizontal Situation Indicator (or Course Deviation Indicator). Enroute (RNV ENR) sensitivity, available by pressing the RNAV button, provides a constant course width of ± 5 NM. Approach (RNV APR) sensitivity, available by pushing the RNAV button again, provides a constant course width of $\pm 1\frac{1}{4}$ NM. Approach sensitivity should be used when within 10 miles of the terminal waypoint. Time and distance to the waypoint, and computed groundspeed are displayed at the top of the display panel.

CONVENTIONAL VOR OPERATION

VOR or VOR-PAR modes are selected by pressing the VOR button; once for VOR and a second time for VOR-PAR. In VOR mode DME is automatically tuned, and distance, groundspeed and time-to-station to the VORTAC station will be displayed upon lock-on. The HSI (CDI) will display conventional angular crosstrack deviation from the selected course ($\pm 10^\circ$ full scale). In VOR-PAR mode operation is identical to VOR except the HSI (CDI) will display crosstrack deviation of ± 5 NM full scale from the selected course. Course width will be constant irrespective of distance from the VORTAC.

ILS OPERATION

The ILS mode is annunciated whenever an ILS frequency is put "in use". LOC/GS functions are annunciated by the LOC and GS flags in the HSI (CDI). Only angular deviation is provided in the ILS mode.

DME HOLD OPERATION

The DME Hold (HLD) function inhibits changing the DME

receiver frequency. Pressing the HOLD button and then selecting a new waypoint forces the KNS-80 into either a conventional VOR or ILS mode of operation according to the newly selected frequency.

Engage DME HOLD as follows:

1. Press the HOLD button.
2. Select the new frequency using the data input controls. HLD will now annunciate. Distance will continue to be read to the VORTAC and information to the HSI (CDI) will be from the newly selected station.

RNAV APPROACH

The RNAV Approach (RNV-APR) mode may be used for runway location (by placing a waypoint at the approach end of the runway) during an approach to an airport. Press the RNAV button to select RNV-APR. In RNV-APR the deviation needle on the HSI (CDI) will display crosstrack deviation of $\pm 1\frac{1}{4}$ NM full scale. All other aspects of the RNV-APR mode are identical to the RNV-ENR mode.

PERFORMANCE - No change

WEIGHT AND BALANCE - No change

SYSTEMS DESCRIPTION

The King KNS-80 is an integrated navigation system combining a 200 channel VOR/Localizer receiver, a 40 channel glideslope receiver, a 200 channel DME, and a digital RNAV computer with a capability for preselection and

FAA Approved
Issued January, 1979
P/N 58-590000-29

storage of 4 VOR/LOC frequencies and RNAV waypoint parameters.

The KNS-80 can be operated in any one of three basic modes: VOR, RNAV, or ILS. To change from one mode to another the appropriate pushbutton switch is pressed, except that the ILS mode is entered automatically whenever an ILS frequency is channeled in the USE waypoint. The display will annunciate the mode by lighting a message above the pushbutton. In addition to the standard VOR and RNAV enroute (RNV ENR) modes, the KNS-80 has a constant course width or parallel VOR mode (VOR-PAR) and an RNAV approach mode (RNV APR). To place the unit in either of these secondary modes, the VOR pushbutton or the RNAV pushbutton, as the case may be, is pushed a second time. Repetitive pushing of the VOR button will cause the system to alternate between the VOR and VOR-PAR modes, while repetitive pushing of the RNAV button causes the system to alternate between RNV ENR and RNV APR modes.

All waypoint information, station frequency, waypoint distance, and waypoint radial are entered with the increment/decrement rotary switch on the right side of the panel and displayed in the right hand readout. The small knob affects the lower significant digits while the large knob changes the most significant digits. The tenth's position of waypoint radial and distance can be changed by pulling the small knob to the out position. The type of data being displayed is indicated by the illuminated messages (FRQ, RAD, DST) located directly below the displayed data. Frequency, radial, or distance information for a waypoint can be displayed sequentially by pressing the "DATA" pushbutton. The increment/decrement switch changes only the information being displayed.

The KNS-80 can store frequency, radial, and distance information for up to four waypoints. The waypoint number of

FAA Approved
Issued January, 1979
P/N 58-590000-29

the data being displayed is located above the message DSP. The DSP waypoint number is changed by pressing the DSP button. The number of the waypoint being used for navigation is indicated by the number above the message USE. If the waypoint in use is different from the displayed waypoint, the DSP waypoint number blinks. Pressing the USE button causes the waypoint in use to match the displayed waypoint.

Normally, the DME is tuned to the station paired with the VOR frequency. The tuning of the DME may be frozen by depressing the HOLD button. Subsequent rechanneling of the NAV receiver will cause the HLD light to illuminate. The DME will "hold" the frequency it was tuned to at the time the button was depressed.

DISPLAYS

1. NM Display

a. VOR and VOR-PAR modes

Displays DME distance in 0.1 NM increments from 0 to 99.9 NM and in 1 NM increments from 100 to 200 NM. Displays dashes whenever DME goes into search.

b. RNV APR and RNV ENR modes

Displays RNAV distance to waypoint in 0.1 NM increments from 0 to 99.9 NM and in 1 NM increments from 100 to 400 NM. Displays dashes if DME is in search, if VOR flags, or if the VOR is rechanneled with the HOLD button depressed.

2. KT Display

a. VOR and VOR-PAR modes

Displays ground speed to the DME ground station in 1 knot increments from 0 to 999 knots. Displays dashes whenever DME goes into search.

b. RNV APR and RNV ENR modes

Displays ground speed to the active waypoint in increments of 1 knot from 0 to 999 knots. Displays dashes whenever DME goes into search, if VOR flags or if the VOR is rechanneled with the HOLD button depressed.

3. MIN Display

a. VOR and VOR-PAR modes

Displays time to DME ground station in 1 minute increments from 0 to 99 minutes. Displays dashes whenever DME goes into search or when calculated time exceeds 99 minutes.

b. RNV APR and RNV ENR modes

Displays time to the active waypoint in 1 minute increments from 0 to 99 minutes. Displays dashes if DME is in search, if VOR flags, if the VOR is rechanneled with the HOLD button depressed, or if calculated time exceeds 99 minutes.

4. FRQ, RAD, DST Display

a. FRQ mode

Displays frequency from 108.00 to 117.95 MHz in

increments of .05 MHz. Least significant digit displays only zero or five.

b. RAD mode

Displays ground station radial on which waypoint is located from 0.0 to 359.9 degrees.

c. DST mode

Displays the offset distance of the waypoint from the ground station over a range of 0.0 to 199.9 NM.

5. USE Display

Displays waypoint number of data (1 to 4) actually being used by the system. In VOR modes only the frequency has meaning. When changed, always takes on DSP value.

6. DSP Display

Displays waypoint number (1 to 4) of data being displayed.

7. PAR, VOR, ENR, APR, RNV Displays

System status lights.

8. HLD Display

Indicates when the station to which the DME is actually tuned is different that the station to which the VOR is tuned.

9. DATA Display

Displays waypoint data. The messages FRQ, DST, and

RAD tell what is being displayed at any one time.

10. ILS Display

Indicates that the frequency in use is an ILS frequency.

CONTROL

1. VOR Button

Momentary pushbutton which, when pushed while the system is in either RNV mode, causes the system to go to VOR mode. Otherwise, the button causes the system to toggle between VOR and VOR-PAR modes.

2. RNAV Button

Momentary pushbutton which, when pushed while the system is in either VOR mode, causes the system to go to RNV ENR mode. Otherwise the button causes the system to toggle between RNV ENR and RNV APR modes.

3. HOLD Button

Two position pushbutton which, when in the depressed position, inhibits DME from channeling to a new station when the VOR frequency is changed. Pushing the button again releases the button and channels the DME to the station paired with the VOR station.

4. USE Button

Momentary pushbutton which, when pressed, causes the active waypoint to take on the same value as the displayed waypoint and the DATA display to go to FRQ mode.

5. DSP Button

Momentary pushbutton which, when pushed, causes displayed waypoint to increment by 1 and DATA display to go to FREQUENCY mode.

6. DATA Button

Momentary pushbutton which, when pressed, causes waypoint DATA display to change from FRQ to RAD to DST and back to FRQ.

7. OFF/PULL ID Control

Rotary switch/potentiometer which, when turned clockwise, applies power to the KNS-80 and increases audio level. Turned counterclockwise it will decrease audio level and switch off power. The switch may be pulled out to hear VOR ident.

8. DATA INPUT Control

Dual concentric knobs with the center knob having an "in" and "out" position.

a. Frequency Data

The outer knob varies the 1MHz digit and the center knob varies the frequency in .05 MHz increments regardless of whether the switch is in its "in" or "out" position.

b. Radial Data

The outer knob varies the 10 degree digit with a carryover occurring from the tens to hundreds position. The center knob in the "in" position varies

the 1 degree digit and in the "out" position varies the 0.1 degree digit.

c. Distance Data

The outer knob varies the 10 NM digit with a carryover occurring from the tens to hundreds place. The center knob in the "in" position varies the 1 NM digit and in the "out" position varies the 0.1 NM digit.

HANDLING SERVICE AND MAINTENANCE

BATTERY REPLACEMENT

The waypoint memory is powered by two silver oxide watch cells located in the lower left hand corner of the front panel. Typical life of the cells is two years although high temperature and humidity conditions can shorten this period. If the batteries should become weak, waypoint storage will be lost and the radio will "wake up" tuned to 110.00 MHz in the VOR mode. The cells can be replaced by opening the battery pocket with a thin blade screwdriver. The holder was designed so that the cells can only be inserted with the correct polarity.

APPROVED:



For

W. H. Schultz
Beech Aircraft Corporation
DOA CE-2

FAA Approved
Issued January, 1979
P/N 58-590000-29

**BEECHCRAFT 95-B55, 95-B55A, E55, E55A, 58,
58A, 58P, 58PA, 58TC & 58TCA LANDPLANE**

**PILOT'S OPERATING HANDBOOK
AND
FAA APPROVED AIRPLANE FLIGHT MANUAL
SUPPLEMENT**

for the

**NARCO AVIONICS RNAV 161 TSO
MULTI-WAYPOINT AREA NAVIGATION SYSTEM**

GENERAL

The information in this supplement is FAA-approved material and must be attached to the Pilot's Operating Handbook and FAA Approved Airplane Flight Manual when the airplane has been modified by installation of the Narco Avionics RNAV 161 Multi-waypoint Area Navigation System in accordance with Beech-approved data.

The information in this supplement supersedes or adds to the basic FAA Approved Airplane Flight Manual only as set forth within this document. Users of this manual are advised always to refer to the supplement for possibly superseding information and placarding applicable to operation of the airplane.

LIMITATIONS

1. The Area Navigation mode may not be used as a primary system under IFR conditions except on approved approach procedures, approved area navigation airways, and random area navigation routes when approved by Air Traffic Control.

**FAA Approved
Issued: January, 1979
P/N 96-590010-27**

2. The Area Navigation mode can only be used with colocated facilities (VOR and DME signals originate from the same geographical location).
3. STD mode must be selected for non-RNAV VOR/LOC navigation.
4. In the approach mode the waypoint use maximum distance is 50 nautical miles.

EMERGENCY PROCEDURES

CAUTION

DME may unlock due to loss of signal with certain combinations of distance from station, altitude, and angle of bank.

1. If NAV flag appears while in the Area Navigation mode, check for correct frequency.
2. If VOR or DME signals are intermittent or lost, utilize other navigation equipment as required.
3. If NAV flag appears during an approach, execute published missed approach and utilize another approved facility.

NORMAL PROCEDURES

PREFLIGHT

LIGHT SEGMENT TEST

To check the display light segments and the function pushbutton lights, perform the following:

1. Switch the system on using either the panel mounted

FAA Approved
Issued: January, 1979
P/N 96-590010-27

ON/OFF switch or the switch on the navigation receiver depending on the installation.

2. Depress TEST pushbutton. Bearing and distance displays will show 888.8, frequency display will show 188.88, and waypoint number display will show an 8. All function pushbuttons (WPT NO, DIST, BRG, FREQ) will illuminate. If the preceding happens, then the system lights and light segments are functioning properly.

"KEEP ALIVE" MEMORY CHECK

If the RNAV 161 system has recently been used, switch ON the system and recall data from the memory banks. Compare data with the data of the flight plan.

If the system has not been recently used enter dummy waypoint number, bearing, distance, and frequency, data (see PROGRAMMING for data procedure) switch the system OFF. Wait several minutes before switching the system ON and then recall dummy program from memory. If the output agrees with the input, the system is functioning properly.

AREA NAVIGATION FUNCTIONAL TEST

The following procedure can only be used at airports equipped with, or in range of, a colocated VOR/DME station.

See PROGRAMMING for data entry procedures.

1. Switch the system ON.
2. Place the RNAV 161 in STD mode.
3. Press FREQ and keyboard known VOR frequency and depress ENTR.
4. Find and record the angle to the VOR station by

FAA Approved

Issued: January, 1979

P/N 96-590010-27

centering the D-Bar with a TO showing (TO/FROM flag).

5. Press BRG and keyboard 120° plus indicated VOR radial of step 4. Depress ENTR.
6. Press DIST and keyboard a waypoint distance equal to the indicated DME value.
7. Place the RNAV 161 in RNAV E mode.
8. Rotate the HSI/OBS until the D-Bar centers with a TO flag.

The RNAV 161 distance-to-station should now read a value equal to the DME distance ($\pm .5$ NM) and the indicated selected course should read 60° greater than the recorded VOR angle to station.

PROGRAMMING

Pertinent information (waypoint number, station frequency, waypoint bearing, and waypoing distance) for up to ten waypoints is entered into the memory from the control unit. Programming may be completed prior to takeoff or during the flight. Any combination of navigational facilities (RNAV waypoint, VOR/DME, ILS) may be loaded into the computer; however, it is desirable that each facility be numbered and loaded in the sequence it is to be used.

RNAV WAYPOINTS

1. Available waypoint numbers are 0 through 9.
2. Switch the system ON using the instrument-panel-mounted ON/OFF switch or the switch on the navigation receiver depending on the installation.
3. Waypoint number is programmed by depressing the function pushbutton marked WP NO and depressing a single number (0 through 9) on the keyboard. Set waypoint 0 for the first waypoint entry.

FAA Approved
Issued: January, 1979
P/N 96-590010-27

NOTE

All displays will extinguish by depressing WP NO and the WP NO function pushbutton will be illuminated indicating that the keyboard has been connected to the waypoint display. On depressing a keyboard number all data in the memory for that number will be displayed.

4. Depress BRG and keyboard the intended bearing. Bearings from 0.0° to 359.9° are possible in increments of $.1^{\circ}$.

Format: XXX.X i.e. 059.8

Decimal point is set automatically for bearings greater than 100° .

NOTE

Pressing the BRG (bearing) pushbutton causes the bearing display to extinguish, and the BRG pushbutton to be illuminated indicating that the keyboard and the bearing display are connected.

5. Depress DIST, enter waypoint distance using the keyboard. A complete distance entry will be indicated when the ENTR pushbutton is illuminated. Depress ENTR to enter the waypoint distance into the memory. Distances in nautical miles from 0.0 through 199.9 in increments of 0.1 may be entered.

Format: XXX.X i.e. 089.1

Distances greater than 100 NM will have the decimal point inserted automatically if the operator fails to place it.

NOTE

Pressing the DIST (distance) pushbutton causes the distance display to extinguish, and the DIST pushbutton to be illuminated indicating that the keyboard and the distance display are connected.

6. Depress **FREQ**, enter four or five digit frequency number using keyboard. When four digits have been entered, the **ENTR** function pushbutton will light. If the desired frequency contains only four digits, depress **ENTR** and the frequency data will be entered into the memory. The lighted pushbutton will extinguish and the display will shift one space to the left automatically adding a zero, for example from 108.2 to 108.20. Five digit frequencies must have all five digits showing on the display before depressing **ENTR**.

Receiver frequencies from 108.00 through 117.95 MHz, in increments of 50 KHz may be entered.

Four and five digit numbers may be entered and the computer will automatically set the decimal point.

NOTE

Pressing the **FREQ** pushbutton causes the frequency display to extinguish, and the **FREQ** pushbutton to be illuminated indicating that the

FAA Approved
Issued: January, 1979
P/N 96-590010-27

keyboard and the frequency display are connected.

7. The RNAV 161 is now fully programmed for waypoint "0". For each additional waypoint entry repeat steps 3 through 6.

ENTRY ERRORS IN PROGRAMMING

Errors may be procedural or errors of depressing the wrong key or pushbutton.

Errors made in entering data may be corrected as follows:

1. Flashing Display - The displays will flash whenever bearing, distance, or frequency data is about to be changed in the active or in-use waypoint.

If the data change is intentional:

- a. Continue the programming procedures as previously described.

If the data change is unintentional:

- a. Using the keyboard, enter into the display any number which will satisfy that display as indicated by the lighting of the ENTR pushbutton, but DO NOT depress the ENTR pushbutton.
- b. Recall the waypoint data from the memory by depressing the WP NO pushbutton and then, on the keyboard, depress the active waypoint number.

The display will have ceased flashing and the waypoint data in the memory will NOT have been changed.

2. Blank Display - Entering a bearing in excess of 359.9° or a distance in excess of 199.9 NM will cause that display to go blank.
 - a. Enter the correct bearing or distance and then depress the ENTR pushbutton and the correct data will be stored in the memory.
3. Correcting Numerical Errors:
 - a. If a wrong number has been struck on the keyboard and the ENTR light is off, clear the error by depressing the keyboard's "C" pushbutton and then make the correct number input.
 - b. If a wrong number has been struck on the keyboard and the ENTR light is on, clear the error by depressing the function pushbutton associated with the display and then enter the correct data, using the keyboard and the ENTR function pushbutton.
4. In general, correction of data in any waypoint number may be accomplished as follows:
 - a. Recall the waypoint data by pressing the WP NO pushbutton and then, on the keyboard, press the number of the waypoint.
 - b. Press the pushbutton associated with the displayed data to be changed (if distance is to be changed, press the DIST pushbutton).
 - c. Using the keyboard enter the correct data into the display. The ENTR pushbutton will light when the display is satisfied.
 - d. Press the ENTR pushbutton to transfer the displayed data into memory.

NOTE

Step b, c, and d are the normal programming procedures and step a is the normal data recall procedure.

QUICK ENTRY PROCEDURE

The table that follows defines the steps required to program waypoint 5 where the VOR/DME station is to be offset 127.5 NM along the 63.0° radial. Station frequency is 115.3 MHz.

Step	Press Pushbutton	Display	Press Keyboard	Display
1	WP NO	ALL BLANK	5	WP NO 5*
2	BRG	BRG Blank	63.0	BRG 063.0
3	DIST	DIST Blank	127.5	DIST 127.5
4	FREQ	FREQ Blank	115.3	FREQ 115.30
5	ENTR	Freq 115.30	-	-

* All data currently in RNAV memory for waypoint 5 will be displayed (memory recall).

INFLIGHT

Preset waypoints and programs in the memory may be recalled and used as required.

WAYPOINT SELECTION

The thumbwheel switch in the upper left corner of the RNAV

161 is used to select the active waypoint. Reference to the flight plan will verify that the active waypoint has been selected.

The TO/FROM flags on the HSI/OBS and the distance displayed on the DME indicator will signal the time to change from one active waypoint to the next active waypoint.

NAV flag appearance on the HSI/OBS will signal a need to change waypoint number (frequency) or the need to change modes (the mode selector switch is directly below the active waypoint thumbwheel, in the lower left corner of the RNAV 161 unit).

RNAV OPERATION

Flight from waypoint to waypoint can be accomplished by using the programmed bearing between waypoints and by keeping the left-right needle of the HSI/OBS centered. Enroute sensitivity in the RNAV E mode is ± 2.5 NM or 5 NM constant course width.

Course width in the RNAV APPR mode is 2.5 NM or a sensitivity of ± 1.25 NM. The RNAV APPR mode is for use when within ten nautical miles of the terminal waypoint. The maximum range for the RNAV APPR mode is 50 nautical miles.

Landings can be made enroute, that is between pre-programmed waypoints, and the RNAV 161 system switched off after landing and the pre-programmed navigational data will be retained in the RNAV 161 memory banks. A memory "Keep Alive" circuit makes this possible.

RNAV APPROACH

The RNAV APPR mode may be used for runway location.

FAA Approved
Issued: January, 1979
P/N 96-590010-27

Program a waypoint to coincide with the approach end of the runway (this may be done in flight or during preflight) then fly the bearing programmed as directed by the HSI/OBS.

CONVENTIONAL VOR

The programming technique for conventional navigation directly toward or away from a VOR facility without a colocated DME is similar to that for RNAV waypoints except that no values are programmed for bearing and distance. Waypoint number and frequency are the input data required.

ILS APPROACH (front course and back course)

Programming an ILS approach is accomplished in the same way as programming conventional VOR.

MISSED APPROACH

If the published missed approach utilizes an RNAV waypoint or VOR facility, it may be entered into the memory any time prior to the approach. Programming is as set forth in the preceding sections.

WEIGHT AND BALANCE - No change.

SYSTEMS DESCRIPTION

The RNAV 161 is a unit of the RNAV 161 Multi-Waypoint Area Navigation System. The system is composed of the following basic units.

1. RNAV 161 - Function: channels data to receiver and VOR/LOC detector out to RNAV, displays data, and mode lights.

2. HSI/OBS (Horizontal Situation Indicator/Omni Bearing Selector) - Function: resolver, left-right needle, to/from and NAV flags.
3. DME (Distance Measuring Equipment) - Function: interrogator/receiver
4. DME (Indicator) - Function: displays distance from/to station
5. NAV REMOTE RECEIVER - Function: receives signal from station and channels data to DME and RNAV 161

This system furnishes the pilot with the alternative to station-to-station VOR navigation and that is: RNAV (Area Navigation). Using this system a pilot can electronically move a VOR/DME (VORTAC or TACAN within NAV frequency band) station to any point within that station's service coverage area. For example, the VOR/DME station could be relocated to a point on an airport's approach pattern; or a relocated station could define one end of a holding pattern. Cross-country flights can be made straight by off-setting VOR/DME stations as required to form a straight line-of-flight from departure point to destination.

Data is entered into the RNAV 161 system by keyboard and function pushbuttons. Pushbuttons are labeled and lighted. Data (waypoint number, bearing, distance, and frequency) is displayed on the RNAV 161 panel. Readout is by light segments. Mode selection (STD, RNAV E, RNAV APPR) is by a three-position selector switch. In flight, waypoint number selection is made by rotating a thumbwheel.

System output is via the HSI/OBS, the DME indicator, and the display of the RNAV 161 panel.

FAA Approved
Issued: January, 1979
P/N 96-590010-27

Memory capacity of the RNAV 161: 10 waypoints, digits 0 through 9.

Displays are lighted with incandescent lights and the intensity of the lights is automatically controlled by a sensor that is activated by cabin ambient light. A TEST pushbutton lights all the usable segments of the display lights as a check.

HANDLING, SERVICE, AND MAINTENANCE

The RNAV 161 has a "KEEP ALIVE" circuit that makes it possible to retain data in the memory banks when the unit is switched OFF. Source of the 11 to 33 VDC required for the "Keep Alive" circuit is the airplane battery. Current drain is 0.1 milliampere. It is important that the battery not be removed from the airplane if data in the memory is to be retained.

APPROVED:

For 
W. H. Schultz
Beech Aircraft Corporation
DOA CE-2

**BEECHCRAFT BARON 95-B55, 95-B55A,
E55, E55A, 58, 58A, 58P, 58PA, 58TC and
58TCA
LANDPLANES**

**PILOT'S OPERATING HANDBOOK AND FAA
APPROVED
AIRPLANE FLIGHT MANUAL SUPPLEMENT
for the
KING KNS-81 INTEGRATED NAVIGATION SYSTEM**

GENERAL

The information in this supplement is FAA-approved material and must be attached to the Pilot's Operating Handbook and FAA Approved Airplane Flight manual when the airplane has been modified by installation of the King KNS-81 Navigation System in accordance with Beech-approved data.

The information in this supplement supersedes or adds to the basic Pilot's Operating Handbook and FAA Approved Airplane Flight Manual only as set forth within this document. Users of this manual are advised always to refer to the supplement for possibly superseding information and placarding applicable to operation of the airplane.

LIMITATIONS

1. The Area Navigation mode may not be used as a primary system under IFR conditions except on approved approach procedures, approved airways, and random area navigation routes when approved by Air Traffic Control.
2. The Area Navigation and VOR-PAR modes can only

**FAA Approved
Revised: October, 1983
P/N 102-590000-53**

be used with colocated facilities (VOR and DME signals originate from the same geographical location).

3. VOR or VOR-PAR modes must be selected when flying directly to or from a VORTAC facility.

EMERGENCY PROCEDURES

CAUTION

DME may unlock due to loss of signal with certain combinations of distance from station, altitude and angle of bank.

1. If NAV flag appears while in the Area Navigation mode, use CHK button to check for validity of raw DME and VOR data.
2. If VOR or DME equipment is intermittent or lost, utilize other navigation equipment as required.
3. If NAV flag appears and/or DME information is lost during an approach, execute published missed approach and utilize another approved facility.

NORMAL PROCEDURES

PREFLIGHT

AREA NAVIGATION FUNCTIONAL TEST

The following procedure applies only to airports equipped

FAA Approved
Revised: October, 1983
P/N 102-590000-53

with, or in range of, a colocated VOR/DME station.

1. Place the KNS-81 in VOR mode.
2. Find and record the angle from the VOR station by centering the course deviation needle with the TO/FROM flag giving a "FROM" indication.
3. Program a waypoint radial angle equal to the OBS value determined in Step 2.
4. Program a waypoint distance equal to the indicated DME value.
5. Place the KNS-81 in RNAV.

The KNS-81 is operating properly if the distance to waypoint is 0 + 1.0 NM and the course deviation needle is within a dot of being centered.

PROGRAMMING

Pertinent information (waypoint number, station frequency, waypoint radial, and waypoint distance) can be entered into the memory. Programming may be completed prior to takeoff or during the flight. Any combination of navigational facilities (RNAV waypoint, VOR/DME, ILS) may be loaded into the computer; however, it is desirable that each facility be numbered and loaded in the sequence it is to be used.

RNAV WAYPOINTS

1. Turn the system on by rotating the ON/OFF switch clockwise.

2. Put waypoint 1 in the WPT window by turning the WPT knob. Turn the knob in either direction to get "1".
3. Select the waypoint 1 frequency using the data input controls which are the two concentric knobs on the right.
4. Select the waypoint 1 radial by depressing the DATA button. This will move the >< (caret) from FRQ to RAD. Select the new radial with the data input controls.
5. Select the waypoint 1 distance by again depressing the DATA button. This will move the >< from RAD to DST. Select the new distance with the data input controls.
6. This completes the programming for the first waypoint. Follow these procedures for all selected waypoints.

CONVENTIONAL VOR

1. The programming technique for conventional navigation directly toward or away from a VOR facility without a colocated DME is similar to that for RNAV waypoints. Putting the waypoint number and frequency into the memory is accomplished in the same manner. The RAD and DST displays will display dashes during VOR and VOR-PAR operation.

ILS APPROACH (Front course and Back course)

1. Programming an ILS approach is accomplished in the same manner as programming conventional VOR.

FAA Approved
Revised: October, 1983
P/N 102-590000-53

MISSED APPROACH

1. If the published missed approach utilizes an RNAV waypoint or VOR facility, it may be entered into the memory any time prior to the approach. This is accomplished in the same manner set forth in CONVENTIONAL VOR and RNAV WAYPOINTS in this section.

INFLIGHT

1. Preset waypoints may be recalled from memory and put into active use as required.

Turn the WPT knob as required to select the desired waypoint. The preset waypoint number, frequency, radial and distance will appear in their respective displays. The WPT display will blink to indicate that the waypoint displayed is other than the active waypoint.

2. Verify that the data is correct.

NOTE

Revisions to the waypoint data can be programmed at this time by entering the new waypoint parameters.

3. When return to the active waypoint is desired, press the RTN button. The active waypoint along with its data will be displayed.
4. When navigation to the displayed (blinking WPT) waypoint is desired, press the USE button. The WPT

display will cease blinking and the displayed waypoint becomes the active waypoint.

5. The raw VOR & DME data can be checked at any time by pressing the CHK button. The radial from the VOR will be displayed above RAD and the DME distance will be displayed above DST.

RNAV OPERATION

If the system is receiving valid signals from a colocated VOR-DME facility, it will supply linear deviation information to the Horizontal Situation Indicator (or Course Deviation Indicator). Enroute (RNAV) sensitivity, available by turning the MODE selector knob until RNAV is displayed, provides a constant course width of ± 5 NM full scale.

Approach (RNAV-APR) sensitivity, available by turning the mode selector knob until RNAV-APR is displayed, provides a constant course width of $\pm 1 \frac{1}{4}$ NM full scale. Approach sensitivity should be selected just prior to final approach course interception. Time and distance to the waypoint and computed groundspeed are displayed on the DME display.

CONVENTIONAL VOR OPERATION

VOR or VOR-PAR modes are selected by turning the MODE selector knob until VOR or VOR-PAR is displayed. In VOR mode the remote DME is automatically tuned when the KNS-81 is selected as the tuning source. Upon lock-on, distance, groundspeed and time to the VORTAC station will be displayed on the DME display. The HSI (CDI) will display conventional angular crosstrack deviation from the selected course ($\pm 10^\circ$ full scale). In VOR-PAR mode, operation is identical to VOR except the HSI (CDI) will display crosstrack deviation of ± 5 NM full scale from the selected course.

FAA Approved
Revised: October, 1983
P/N 102-590000-53

Course width will be constant irrespective of distance from the VORTAC.

Anytime the RAD button is engaged, the radial from the waypoint/station will be displayed on the DME knots display along with an "F" on the DME time to station display.

NOTE

The RAD switch is not the momentary type, therefore, the switch must be pressed again for the normal DME information to be displayed.

ILS OPERATION

Whenever an ILS Frequency is put "IN USE" the mode display will remain the same (either VOR, VOR-PAR, RNAV, RNAV-APR displayed) but the RAD & DST displays will be blanked. Absence of the LOC/GS functions is annunciated by the NAV and GS flags in the HSI (CDI). Only angular deviation is provided in the ILS Mode.

RNAV APPROACH

The RNAV Approach (RNAV-APR) mode may be used for runway location (by placing a waypoint at the approach end of the runway) during an approach to an airport. Turn the MODE selector knob to select RNAV-APR. In RNAV-APR the deviation needle on the HSI (CDI) will display crosstrack deviation of $\pm 1 \frac{1}{4}$ NM full scale. All other aspects of the RNAV-APR mode are identical to the RNAV mode.

PERFORMANCE - No change

FAA Approved
Revised: October, 1983
P/N 102-590000-53

WEIGHT AND BALANCE - No change

SYSTEMS DESCRIPTION

The King KNS-81 is an integrated navigation system combining a 200-channel VOR/Localizer receiver, a 40 channel glideslope receiver and a digital RNAV computer with a capability of preselection and storage of 9, or on later models 10, VOR/LOC frequencies and equivalent sets of RNAV waypoint parameters. A DME System must be used in conjunction with the KNS-81.

The KNS-81 can be operated in any one of three basic modes: VOR, RNAV, or ILS. To change from one mode to another the rotary MODE selector knob on the left side of the panel is rotated, except that the ILS Mode is entered automatically whenever an ILS frequency is channeled as the ACTIVE frequency. The display will annunciate the mode by lighting a message beside the WPT display, except in the ILS mode in which case the RAD & DST displays are blanked to denote the ILS mode. In addition to the standard VOR & RNAV enroute (RNAV) modes, the KNS-81 has a constant course width or parallel VOR mode (VOR-PAR) and an RNAV approach mode (RNAV-APR). The same rotary MODE selector knob is used to place the unit in either of these secondary modes.

All waypoint information (station frequency, waypoint distance and waypoint radial) is entered with the increment/decrement rotary switch on the right side of the panel and displayed in their respective displays. The small knob affects the least significant digits while the large knob changes the most significant digits. The tenth's position of waypoint radial and distance can be changed by pulling the small knob to the out position. The type of data being selected is indicated by the illuminated carets (><) located

FAA Approved

Revised: October, 1983

P/N 102-590000-53

by either FRQ, RAD or DST. Frequency, radial or distance information for a waypoint can be selected sequentially by pressing the DATA push button. The increment/decrement switch changes only the information being displayed with the carets.

The KNS-81 can store frequency, radial and distance information for up to nine waypoints. The waypoint number of the data being displayed is located above the message WPT. This waypoint number is changed by rotating the WPT selector knob (small center knob) on the left side of the panel. If the waypoint in use is different from the displayed Waypoint (WPT blinking), pressing the USE button will cause the displayed WPT to become the waypoint in use.

DISPLAYS

1. FRQ, RAD, DST Display

a. FRQ Display

Displays frequency from 108.00 to 117.95 MHz in increments of .05 MHz. Least significant digit displays only zero or five.

b. RAD Display

Displays ground station radial on which waypoint is located from 0.0 to 359.9 degrees.

c. DST Display

Displays the offset distance of the waypoint from the ground station over a range of 0.0 to 199.9 NM.

2. VOR, PAR, RNAV, RNAV-APR Displays

System mode lights

3. WPT Display

■ Displays waypoint number of data being displayed.

4. Carets (><) Display

Indicates which waypoint data (FRQ, RAD or DST) the increment/decrement rotary switch will change.

5. DME Indicator (Remote)

Displays NM to/from the waypoint/station, KT groundspeed and MIN time to the waypoint/station. Also, the waypoint radial is displayed whenever the KNS-81 RAD Button is pressed.

6. RMI Display (Optional)

Displays the bearing to the waypoint/station.

CONTROLS

1. WPT/MODE Control

Dual concentric knobs.

- a. The outer knob selects the MODE of unit operation. Turning the knob clockwise causes the mode to sequence thru VOR, VOR-PAR, RNAV, RNAV-APR and then back to the VOR mode.

FAA Approved
Revised: October, 1983
P/N 102-590000-53

- b. The center knob selects the WPT to be displayed. Turning the knob causes the displayed waypoint to increment by one thru the waypoint sequence of 1, 2, 8, 9, 1, or on later models 0, 1, 8, 9, 0.

2. USE Button

Momentary pushbutton which, when pressed, causes the active waypoint to take on the same value as the displayed waypoint.

3. RTN Button

Momentary pushbutton which, when pressed, causes the active waypoint to return to the display.

4. RAD Button

Push-on, push-off button which, when pushed on, causes the radial from the waypoint and "F" to be displayed on the remote DME display.

5. CHK Button

Momentary pushbutton which, when pressed, causes the raw data from the NAV Receiver and DME to be displayed. The radial from the VOR Ground Station will be displayed on the RAD display and the distance from the station will be displayed on the DST display. There is no effect on any other data output.

6. DATA Button

Momentary pushbutton which, when pressed, causes the caret (><) display to change from FRQ to RAD to DST and back to FRQ.

7. OFF/PULL ID Control

Rotary switch/potentiometer which, when turned clockwise, applies power to the KNS-81 and increases NAV audio level. The switch may be pulled out to hear VOR ident.

8. DATA INPUT Control

Dual concentric knobs with the center knob having an "in" and "out" position.

a. Frequency Data

The outer knob varies the 1 MHz and 10 MHz digits and the center knob varies the frequency in .05 MHz increments which carry to/from the .1 MHz digit regardless of whether the switch is in its "in" or "out" position.

b. Radial Data

The outer knob varies the 10 degree digit with a carryover occurring from the tens to hundreds position. The center knob in the "in" position varies the 1 degree digit and in the "out" position varies the 0.1 degree digit.

c. Distance Data

The outer knob varies the 10 NM digit with a carryover occurring from the tens to hundreds place. The center knob in the "in" position varies the 1 NM digit and in the "out" position varies the 0.1 NM digit.

HANDLING, SERVICE AND MAINTENANCE - No change

Approved:

Donald H. Petz

for

W. H. Schultz
Beech Aircraft Corporation
DOA CE-2

**BEECHCRAFT BARON D55/D55A (TE-452 thru TE-767),
E55/E55A (TE-768 thru TE-1083), and 58/58A (TH-1
thru TH-1395, Except TH-1389) LANDPLANES**

**PILOT'S OPERATING HANDBOOK
AND
FAA APPROVED AIRPLANE FLIGHT MANUAL
SUPPLEMENT**

for the

DUAL VOLTAGE REGULATORS (KIT NO. 55-3024)

GENERAL

The information in this supplement is FAA-approved material and must be attached to the Pilot's Operating Handbook and FAA Approved Airplane Flight Manual when the airplane has been modified by the installation of Dual Voltage Regulators (Kit No. 55-3024) in accordance with Beech-approved data.

The information in this supplement supersedes or adds to the basic Pilot's Operating Handbook and FAA Approved Airplane Flight Manual only as set forth below. Users of the handbook are advised always to refer to the supplement for possibly superseding information and placarding applicable to operation of the airplane.

LIMITATIONS

No Change.

**FAA Approved
Issued: May, 1984
P/N 58-590000-37**

EMERGENCY PROCEDURES

ILLUMINATION OF ALTERNATOR-OUT ANNUNCIATOR

In the event of the illumination of a single ALTERNATOR-OUT annunciator:

1. Check corresponding loadmeter for load indication.
 - a. No Load - Turn off affected alternator.
 - b. Regulate load to less than 100% on remaining alternator.
 - c. Affected Alternator - ON. Check loadmeter for load indication.
 - d. No Load - Turn off affected alternator and leave off.

In the event of the illumination of both ALTERNATOR-OUT annunciators:

1. Check load meters for load indication.
 - a. No Load - Turn both alternator switches off.
 - b. Reduce load to minimum (must be less than the rating for one alternator).
 - c. Left Alternator - ON. If no indication on loadmeter, turn off and leave off.
 - d. Right Alternator - ON. If no indication on loadmeter, turn off and leave off.
 - e. Adjust electrical load.
2. If condition indicates malfunction of both alternator circuits:
 - a. Both ALT Switches - OFF
 - b. Minimize electrical load since only battery power will be available.

FAA Approved
Issued: May, 1984
P/N 58-590000-37

NORMAL PROCEDURES

No Change.

PERFORMANCE

No Change.

WEIGHT AND BALANCE

No Change.

SYSTEMS DESCRIPTION

ALTERNATORS

Two standard 60-ampere, or optional 100-ampere, 28-volt, gear-driven alternators are individually controlled by alternator control units which regulate the voltage, balance the load, and provide overvoltage protection. Each alternator system is controlled by a switch located on the subpanel.

HANDLING, SERVICING AND MAINTENANCE

No Change.

Approved:



For

W. H. Schultz
Beech Aircraft Corporation
DOA CE-2

Raytheon Aircraft

Beech® Baron 58/58A Landplanes
(Serials TH-1 thru TH-1471, TH-1476,
TH-1487, TH-1489 and TH-1498)

PILOT'S OPERATING HANDBOOK AND FAA APPROVED AIRPLANE FLIGHT MANUAL SUPPLEMENT

for

Flight In Icing Conditions

*This Supplement is applicable to the following Manual(s):
58-590000-21, 58-590000-31B, 58-590000-35*

Airplane Serial Number: _____

Airplane Registration Number: _____

FAA Approved _____

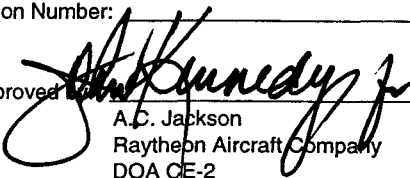
A.C. Jackson
Raytheon Aircraft Company
DOA OE-2

Copyright © Raytheon Aircraft Company 1998

FAA Approved
Revised: September, 1998
P/N 58-590000-33

1 of 16

CONTENTS

GENERAL.....	Page 2
LIMITATIONS.....	Page 2
EMERGENCY PROCEDURES	Page 7
NORMAL PROCEDURES	Page 12
PERFORMANCE	Page 15
WEIGHT & BALANCE	Page 16
SYSTEMS DESCRIPTION.....	Page 16
HANDLING, SERVICING & MAINTENANCE.....	Page 16

GENERAL

The installation of Beech Kit No. 58-5012 properly equips the airplane for flight in icing conditions. The limitations and procedures herein supersede those in the basic Pilot's Operating Handbook and must be followed during icing flight operation. Users of the manual are advised always to refer to the supplement for possibly superseding information and placarding applicable to operation of the airplane.

LIMITATIONS

AIRSPEED LIMITATIONS

Minimum Airspeed During Icing Conditions130 KIAS

MISCELLANEOUS INSTRUMENT MARKINGS

DEICING PRESSURE GAGE

Normal Operating Range
(Green Arc)9-20 psi

Maximum Operating Range
(Red Radial)..... 20 psi

PROPELLER DEICING AMMETER

Normal Operating Range

(Green Arc) (2-Blade) 7 to 12 amps

Normal Operating Range

(Green Arc) (3-Blade) 14 to 18 amps

PNEUMATIC SURFACE DEICE BOOTS

Minimum Ambient Temperature

Operating Limit. -40°C

PNEUMATIC PUMPS

Pneumatic pumps are time limited to 600 hours of engine operation.

PROPELLER DEICE

Do not operate the propeller deice system when propellers are static.

WINDSHIELD HEAT

Ground use of windshield heat is limited to 10 minutes at a time.

LIMITATIONS WHEN ENCOUNTERING SEVERE ICING CONDITIONS

(Required By FAA AD 98-04-24)

WARNING

Severe icing may result from environmental conditions outside of those for which the airplane is certificated. Flight in freezing rain, freezing drizzle, or mixed icing conditions (supercooled liquid water and ice crystals) may result in ice build-up on protected surfaces exceeding the capability of the ice protection system, or may result in ice forming aft of the protected surfaces. This ice may not be shed using the ice protection systems, and may seriously degrade the performance and controllability of the airplane.

1. During flight, severe icing conditions that exceed those for which the airplane is certificated shall be determined by the following visual cues. If one or more of these visual cues exists, immediately request priority handling from Air Traffic Control to facilitate a route or an altitude change to exit the icing conditions.
 - a. Unusually extensive ice accumulation on the airframe and windshield in areas not normally observed to collect ice.
 - b. Accumulation of ice on the upper surface of the wing, aft of the protected area.
 - c. Accumulation of ice on the engine nacelles and propeller spinners farther aft than normally observed.
2. Since the autopilot, when installed and operating, may mask tactile cues that indicate adverse changes in handling characteristics, use of the autopilot is prohibited when any

FAA Approved
Revised: September, 1998
P/N 58-59000-33

of the visual cues specified above exist, or when unusual lateral trim requirements or autopilot trim warnings are encountered while the airplane is in icing conditions.

3. All wing icing inspection lights must be operative prior to flight into known or forecast icing conditions at night. [NOTE: This supersedes any relief provided by the Master Minimum Equipment List (M MEL).]

PLACARDS

On Left Windshield Post:

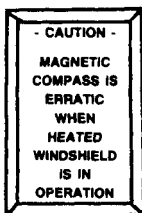

On Pilot's Left Sidewall Panel (All Airplanes):

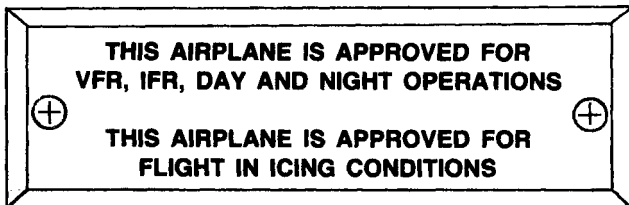

REQUIRED EQUIPMENT FOR FLIGHT IN ICING CONDITIONS

The following list summarizes the Beech approved equipment that must be installed per Beech Kit No. 58-5012 and operable for flight in icing conditions. Other required equipment, found in the LIMITATIONS Section for flight in instrument conditions, must also be operable.

1. Antennas for which strength and locations have been approved for flight in icing conditions.
2. Combustion Heater
3. Current Flight In Icing Conditions Supplement (58-590000-33)
4. Electrothermal Heated Windshield Segment
5. Electrothermal Propeller Deice System
6. Emergency Static Air Source System
7. Fuel Vent Heaters
8. Heated Pitot Tube
9. Stall Warning Heater
10. Surface Deice System (Inboard and Outboard Wing, Horizontal and Vertical Stabilizer Deice Boots)
11. Two Alternators, both rate at 85- or 100-amperes
12. Wing Ice Lights (Left Side)

NOTE

Flight in icing conditions is prohibited when an abnormal operation of any ice protection system is found or indicated.

EMERGENCY PROCEDURES

ICE PROTECTION

SURFACE DEICE SYSTEM

1. Failure of AUTO Operation:
 - Surface Deice Switch - MANUAL (Do not hold more than 8 seconds)

NOTE

The boots will inflate only as long as the switch is held in the MAN (manual) position. When the switch is released the boots will deflate.

2. Failure of boots to deflate:
 - a. Pull Surface Deice circuit breaker on pilot's left side panel.
 - b. If boots reinflate after Surface Deice circuit breaker is reset, use circuit breaker as a manual surface deice switch, following the procedures outlined in Step 1.
3. Failure of AUTO and MAN modes of operation:
 - Leave icing conditions as soon as possible.

ELECTROTHERMAL PROPELLER DEICE SYSTEM

An abnormal reading on the Propeller Deice Ammeter indicates need for the following action:

1. Zero Amps:

Check propeller deice circuit breaker. If the circuit breaker has tripped, a wait of approximately 30 seconds is necessary before resetting. If ammeter reads 0 and the circuit breaker has not tripped, check loadmeters for deflection as propeller deice switch is cycled to confirm a malfunction of the ammeter. If loadmeters do not show a deflection, consider the propeller deice system to be inoperative.

2. Zero to 7 Amps, 2-Blade Propeller; Zero to 14 Amps, 3-Blade Propeller:

If the propeller deice system ammeter occasionally or regularly indicates less than 7 amps for 2-blade (or 14 amps for 3-blade), operation of the propeller deice system can continue unless serious propeller imbalance results from irregular ice shedding.

3. 12 to 15 Amps, 2-Blade Propeller; 18 to 23 Amps, 3-Blade Propeller:

If the propeller deice system ammeter occasionally or regularly indicates 12 to 15 amps for 2-blade (or 18 to 23 amps for 3-blade) operation of the propeller deice system can continue unless serious propeller imbalance results from irregular ice shedding.

4. More than 15 Amps, 2-Blade Propeller; More than 23 Amps, 3-Blade Propeller:

If the propeller deice system ammeter occasionally or regularly indicates more than 15 amps for 2-blade (or more than 23 amps for 3-blade), the system should not be operated unless the need for propeller deicing is urgent.

NOTE

If the propeller deice system becomes inoperative, leave icing conditions as soon as possible. Cycling of the propeller rpm will assist the propellers in shedding ice.

EMERGENCY STATIC AIR SOURCE SYSTEM

THE EMERGENCY STATIC AIR SOURCE SHOULD BE USED ANYTIME THE NORMAL STATIC SOURCE IS OBSTRUCTED. When the airplane has been exposed to moisture and/or icing conditions (especially on the ground), the possibility of obstructed static ports should be considered. Partial obstruction will result in the rate of climb indication being sluggish during a climb or descent.

Verification of suspected obstruction is possible by switching to the emergency system and noting a sudden sustained change in rate of climb. This may be accompanied by abnormal indicated airspeed and altitude changes beyond normal calibration differences.

Whenever any obstruction exists in the Normal Static Air System, or the Emergency Static Air System is desired for use:

1. Emergency Static Air Source - Switch to ON EMERGENCY (lower sidewall adjacent to pilot)
2. For Airspeed Calibration and Altimeter Corrections, refer to the PERFORMANCE Section.

CAUTION

The emergency static air valve should remain in the OFF NORMAL position when system is not needed.

ELECTROTHERMAL HEATED WINDSHIELD SEGMENT

Failure of the heated windshield segment can be confirmed by cycling the WSHLD HEAT switch OFF, then on. If a deflection of the loadmeter is not apparent, consider the system inoperative and exit icing conditions. Partial windshield deicing may be accomplished using the defroster. Maximum defrost heat is achieved as follows:

1. Heater Switch - HEATER

2. Cabin Air Control - PULL AFT (not more than 1/2 travel)
3. Cabin Heat Control - PULL OUT
4. Defrost Control - PUSH IN or PULL OUT, as appropriate, to turn defrost ON
5. Pilot Air Control - PUSH IN
6. Copilot Air Control - PUSH IN

HEATED PITOT TUBE

Failure of the pitot heat in icing conditions may be noticed by a rapid decrease in airspeed, or some other inappropriate reading for the given flight condition. Leave icing conditions as soon as possible.

LOSS OF ONE ALTERNATOR

Turn off unnecessary electrical equipment such as excess radios, navigation equipment, and one pitot heat if dual pitot heat is available, so as not to exceed alternator capacity of 1.0 (100-Amp) or .85 (85-Amp) on the loadmeter. Leave icing conditions as soon as possible.

SEVERE ICING CONDITIONS

(Alternate Method Of Compliance With FAA AD 98-04-24)

THE FOLLOWING WEATHER CONDITIONS MAY BE CONDUCTIVE TO SEVERE IN-FLIGHT ICING:

- Visible rain at temperatures below 0 degrees Celsius ambient air temperature.
- Droplets that splash or splatter on impact at temperatures below 0 degrees Celsius ambient air temperature.

PROCEDURES FOR EXITING THE SEVERE ICING ENVIRONMENT:

These procedures are applicable to all flight phases from takeoff to landing. Monitor the ambient air temperature. While severe icing may form at temperatures as cold as -18 degrees Celsius, increased vigilance is warranted at temperatures around freez-

ing with visible moisture present. If the visual cues specified in the Limitations Section of this supplement for identifying severe icing conditions are observed, accomplish the following:

1. Immediately request priority handling from Air Traffic Control to facilitate a route or an altitude change to exit the severe icing conditions in order to avoid extended exposure to flight conditions more severe than those for which the airplane has been certificated.
2. Avoid abrupt and excessive maneuvering that may exacerbate control difficulties.
3. Do not engage the autopilot.
4. If the autopilot is engaged, hold the control wheel firmly and disengage the autopilot.
5. If an unusual roll response or uncommanded roll control movement is observed, reduce the angle-of-attack.
6. Do not extend flaps when holding in icing conditions. Operation with flaps extended can result in a reduced wing angle-of-attack, with the possibility of ice forming on the upper surface further aft on the wing than normal, possibly aft of the protected area.
7. If the flaps are extended, do not retract them until the airframe is clear of ice.
8. Report these weather conditions to Air Traffic Control.

NORMAL PROCEDURES

BEFORE TAKEOFF

SURFACE DEICE SYSTEM

1. Right Throttle - 2000 RPM
2. Surface Deice Switch - AUTO (up), and RELEASE
 - a. CHECK VISUALLY FOR INFLATION AND 15 PSI MINIMUM DEICE PRESSURE
 - b. CHECK VISUALLY FOR HOLD DOWN WHEN CYCLE IS COMPLETE
3. Right Throttle - IDLE
4. Left Throttle - 2000 RPM (Repeat Step 2)
5. Surface Deice Switch - MAN (down), UNTIL PRESSURE PEAKS (not more than 8 seconds), then RELEASE
 - a. CHECK VISUALLY FOR INFLATION AND 15 PSI MINIMUM DEICE PRESSURE
 - b. CHECK VISUALLY FOR HOLD DOWN WHEN CYCLE IS COMPLETE
6. Left Throttle - IDLE

ELECTROTHERMAL PROPELLER DEICE

1. Propeller Deice Switch - ON
2. Propeller Deice Ammeter - CHECK, 7 to 12 amps (2-Blade), 14 to 18 amps (3-Blade)
3. Propeller Deice Switch - OFF (if not required for takeoff)

FUEL VENT HEAT, STALL WARNING HEAT, PITOT HEAT(S), WINDSHIELD HEAT, AND ICE LIGHT

1. Either Alternator - OFF
2. Switches - CYCLE ON AND OFF, ONE AT A TIME (Note needle deflection on operating alternator's loadmeter. The Stall Warning Heat and Ice Light produce only a slight needle movement of the loadmeter.)

FAA Approved
Revised: September, 1998
P/N 58-590000-33

3. Both Alternators - ON
4. All Heat Switches - ON (if take-off conditions require)

CAUTION

Prolonged operation on the ground can damage the pitot heat system.

IN FLIGHT

WARNING

Minimum airspeed for flight in icing conditions is 130 KIAS. This applies to all phases of flight except take-off and landing. If airspeed is decreasing due to ice accumulation, and power or altitude changes fail to curtail airspeed deceleration, alter flight to exit icing conditions before speeds of less than 130 KIAS are reached.

CAUTION

Flight in icing conditions may eventually cause the cowling inlets to become partially blocked, resulting in higher cylinder head temperatures. If cowl flaps are required to keep cylinder head temperatures below the red line, the flight should be altered to leave the icing conditions as soon as possible.

SURFACE DEICE SYSTEM

NOTE

Deicing pressure gage will indicate approximately 5 psi during periods when boots are not utilized.

When ice accumulates 1/2 to 1 inch:

1. Surface Deice Switch - AUTO (up)
2. Deice Pressure - 15 PSI MINIMUM (when boots are fully inflated) and 9 to 20 psi (while boots are inflating)
3. Repeat - AS REQUIRED

CAUTION

Rapid cycles in succession or cycling before at least 1/2 inch of ice has accumulated may cause the ice to grow outside the contour of the inflated boots and prevent ice removal.

NOTE

Either engine will supply sufficient vacuum and pressure for deice operation.

ELECTROTHERMAL PROPELLER DEICE

- Propeller Deice Switch - ON. The system may be operated continuously in flight and will function automatically until the switch is turned OFF.

ELECTROTHERMAL WINDSHIELD ANTI-ICE

- WSHLD HEAT Switch (prior to entering icing conditions)
- ON

FAA Approved
Revised: September, 1998
P/N 58-590000-33

NOTE

Continuous operation is permitted. If directional gyro is to be reset, turn the Windshield Heat OFF for 15 seconds to allow a stable reading of the standby compass.

PITOT HEAT, STALL WARNING HEAT, AND FUEL VENT HEAT

Switches should be ON prior to entering icing conditions. Switches may be left ON during flight.

AFTER LANDING

- Fuel Vent, Stall Warning, Pitot, Propeller and Windshield Heat Switches - OFF

PERFORMANCE

1. On a clean airplane (no ice build-up) stall speeds are increased 4 knots in all configurations when surface deice boots are inflated.
2. Residual ice on the airplane can disrupt the airflow over lifting surfaces and may cause an increase in stall speeds and a change in the amount of warning provided by the stall warning vane.
3. The wings, stabilizers, and all control surfaces must be cleared of frost, ice or snow prior to takeoff.
4. Ice accumulations on unprotected surfaces will decrease climb rates, cruise speeds, and range. Therefore, flight planning should be accomplished for altitudes where adequate performance margins exist.
5. Two-engine climb performance at maximum continuous power will be reduced due to the 130 KIAS minimum climb speed.
6. The minimum recommended holding speed in icing conditions is 140 KIAS.

WEIGHT AND BALANCE

No Change

SYSTEMS DESCRIPTION

STALL WARNING ANTI-ICE

The stall warning vane and mounting pad are equipped with heating elements which are actuated any time the switch placarded STALL HEAT is ON. The switch is located on the pilot's subpanel.

HANDLING, SERVICING AND MAINTENANCE

PNEUMATIC PUMPS

Pneumatic pumps are time limited to 600 hours of engine operation.

BEECHCRAFT SERIES 33,35,36,55,58

**PILOT'S OPERATING HANDBOOK AND FAA
APPROVED AIRPLANE FLIGHT MANUAL
SUPPLEMENT**

FOR

**INSIDE CABIN DOOR HANDLE WITH OPEN/
CLOSED PLACARD**

**THIS SUPPLEMENT IS APPLICABLE TO PILOT'S
OPERATING HANDBOOKS AND FAA APPROVED
AIRPLANE FLIGHT MANUALS:**

(SEE NEXT PAGE FOR APPLICABILITY)

Airplane Serial Number: _____

Airplane Registration Number: _____

FAA Approved:

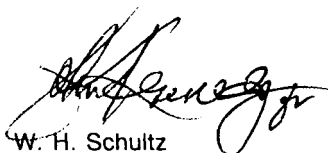

W. H. Schultz
Beech Aircraft Corporation
DOA CE-2

COPYRIGHT © BEECH 1990

**FAA Approved
P/N 58-590000-49
Issued: December, 1990**

1 of 7

This supplement applies to the following Pilot's Operating Handbooks and FAA Approved Airplane Flight Manuals:

MODEL	PART NUMBER	A/C SERIALS
35-B33	33-590000-17B	All
35-C33, E33, F33	33-590002-9B	All
35-C33A, E33A, E33C	33-590003-7B	All
F33A, F33C	33-590009-13	CE-674 & after, CJ-129 & after
F33A, F33C	33-590009-15	CE-290 thru CE- 673, CJ-26 thru CJ-128
G33	33-590027-3	All
F35	35-590071-13	All
G35	35-590072-9	All
H35	35-590073-15	All
N35, P35	35-590094-7	All
S35-TC	35-590110-3	All
S35	35-590110-11B	All
V35-TC	35-590113-3	All
V35A-TC	35-590116-3	All
V35B-TC	35-590118-23	D-9069 thru D- 9947
V35B	35-590118-29	D-9948 & after
V35, V35A, V35B	35-590118-31B	D-7977 thru D- 9947
A36	36-590002-17	E-927 thru E-2110 except E-1946 & E-2104
36, A36	36-590002-19C	E-1 thru E-926
A36	36-590002-37	E-1946, E-2104, E- 2111 & after
A36-TC	36-590003-3	EA-1 thru EA-272 except EA-242

MODEL	PART NUMBER	A/C SERIALS
B36-TC	36-590006-3	EA-242, EA-273 thru EA-388
B36-TC	36-590006-19	except EA-326 EA-326, EA-389 & after
95-B55B 95-55, 95-A55	55-590000-49 55-590000-65B	All TC-1 thru TC-501 except TC-350 & TC-371
58, 58A	58-590000-21	TH-773 thru TH- 1395 except TH- 1389
58, 58A 58, 58A	58-590000-31B 58-590000-35	TH-1 thru TH-772 TH-1389, TH-1396 thru TH-1471, TH- 1476, TH-1487, TH- 1489, TH-1498
58, 58A	58-590000-39	TH-1472 & after, except TH-1476, TH-1487, TH-1489, TH-1498
E55, E55A 95-C55, 95-C55A, D55, D55A, E55, E55A E55, E55A	96-590010-17 96-590010-29B 96-590010-31	TE-1084 & after TC-350, TE-1 thru TE-942, except TE-938 TE-938, TE-943 thru TE-1083
E55, E55A 95-B55, 95-B55A 95-B55, 95-B55A	96-590010-37 96-590011-17 96-590011-23	TE-1197 only TC-2003 & after TC-1608 thru TC- 2002
95-B55, 95-B55A	96-590011-25	TC-371, TC-502 thru TC-1607
58TC 58TC, 58TCA	106-590000-5 106-590000-19	TK-1 thru TK-84 TK-85 thru TK-150, except TK-147

MODEL	PART NUMBER	A/C SERIALS
58TC, 58TCA	106-590000-21	TK-147, TK-151 & after

CONTENTS

GENERAL	Page 5
LIMITATIONS	Page 5
EMERGENCY PROCEDURES	Page 6
NORMAL PROCEDURES	Page 6
PERFORMANCE	Page 6
WEIGHT & BALANCE	Page 6
SYSTEMS DESCRIPTION	Page 6
HANDLING, SERVICING & MAINTENANCE	Page 7

GENERAL

The information in this supplement is FAA-approved material and must be attached to the Pilot's Operating Handbook and FAA Approved Airplane Flight Manual when the airplane has been modified by installation of the Inside Cabin Door Handle With Open/Closed Placard in accordance with Beech Kit 35-5050.

The information in this supplement supersedes or adds to the basic Pilot's Operating Handbook and FAA Approved Airplane Flight Manual only as set forth below. Users of the manual are advised to always refer to the supplement for possibly superseding information and placarding applicable to operation of the airplane.

LIMITATIONS

PLACARDS

On inside of Cabin Door Adjacent to Door Handle:

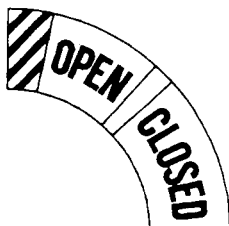

FAA Approved
P/N 58-590000-49
Issued: December, 1990

EMERGENCY PROCEDURES

No change.

NORMAL PROCEDURES

BEFORE TAKEOFF

All procedures specified in the Pilot's Operating Handbook and FAA Approved Airplane Flight Manual for the particular airplane shall be completed. In addition, accomplish the following:

- Doors and Windows - SECURE (Check cabin door lock indicator - CLOSED)

PERFORMANCE

No change.

WEIGHT AND BALANCE

No change.

SYSTEMS DESCRIPTION

DOORS, WINDOWS AND EXITS

CABIN DOOR

The airplane has a conventional cabin door on the forward right side of the fuselage and when closed, the outside cabin door handle is spring loaded to fit into a recess in the door to create a flat aerodynamically clean surface. The door may be locked with a key. To open the door from the outside, lift the handle from its recess and pull until the door opens.

To close the cabin door from the inside, observe that the door handle is in the open position. In this position, the latch handle is free to move approximately one inch in either direction before engagement of the locking mechanism. Then grasp the door and firmly pull the door closed. Rotate the door handle fully counterclockwise into the locked position. Observe that the door handle indicator is in the CLOSED position. When the door is properly locked, the door latch handle is free to move approximately one inch in either direction.

NOTE

When checking the door latch handle, do not move it far enough to engage the door latch release mechanism.

Press firmly outward at the top rear corner of the door. If any movement of the door is detected, completely open the door and close again following the above instructions.

To open the door from the inside, depress the lock button and rotate the handle clockwise.

HANDLING, SERVICING, AND MAINTENANCE

No change.

**BEECHCRAFT 33, 35, 36, 55, 58 SERIES
LANDPLANES**

**PILOT'S OPERATING HANDBOOK AND FAA
APPROVED AIRPLANE FLIGHT MANUAL
SUPPLEMENT**

FOR THE

FULL FLAP WARNING HORN SYSTEM

**THIS SUPPLEMENT IS APPLICABLE TO PILOT'S
OPERATING HANDBOOKS AND FAA APPROVED
AIRPLANE FLIGHT MANUALS:**

(SEE NEXT PAGE FOR APPLICABILITY)

Airplane Serial Number: _____

Airplane Registration Number: _____

FAA Approved:

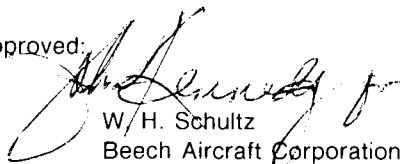

W. H. Schultz
Beech Aircraft Corporation
DOA CE-2

COPYRIGHT © BEECH 1990

FAA Approved
P/N 36-590002-47
Issued: December, 1990

The supplement noted herein applies to the following Pilot's Operating Handbooks and FAA Approved Airplane Flight Manuals:

33-590009-13	F33A Serials CE-816 thru CE-1306, except CE-1301 F33C Serials CJ-149 thru CJ-179
35-590118-29	V35B Serials D-10179 thru D-10403
36-590002-17	A36 Serials E-1371 thru E-2110, except E-1946 and E-2104
36-590002-37	A36 Serials E-1946, E-2104, E-2111 thru E-2467, except E-2458
36-590003-3	A36TC Serials EA-1 thru EA-272, except EA-242
36-590006-3	B36TC Serials EA-242, EA-273 thru EA-388, except EA-320
36-590006-19	B36TC Serials EA-320, EA-389 thru EA-487
96-590011-17	95B55 Serials TC-2003 thru TC-2456
96-590010-29	95C55 Serials TC-350, TE-1 thru TE-451 D55 Serials TE-452 thru TE-767 E55 Serials TE-768 thru TE-942, except TE-938

FAA Approved
P/N 36-590002-47
Issued: December, 1990

96-590010-31	E55 Serials TE-938, TE-943 thru TE-1083
96-590010-17	E55 Serials TE-1084 thru TE-1201
58-590000-31	58 Serials TH-1 thru TH-772
58-590000-21	58 Serials TH-773 thru TH-1395, except TH-1389
58-590000-35	58 Serials TH-1389, TH-1396 thru TH-1471, TH-1476, TH-1487, TH-1489, TH-1498
58-590000-39	58 Serials TH-1472 thru TH-1543, except TH-1476, TH-1487, TH-1489, and TH-1498

CONTENTS

GENERAL	Page 4
LIMITATIONS	Page 4
EMERGENCY PROCEDURES	Page 4
NORMAL PROCEDURES	Page 4
PERFORMANCE	Page 5
WEIGHT & BALANCE	Page 5
SYSTEMS DESCRIPTION	Page 5
HANDLING, SERVICING & MAINTENANCE	Page 5

GENERAL

The information in this supplement is FAA-approved material and must be attached to the Pilot's Operating Handbook and FAA Approved Airplane Flight Manual when the airplane has been modified by installation of the Full Flap Warning Horn System in accordance with Beech Kit Drawing 36-3012.

The information in this supplement supersedes or adds to the basic Pilot's Operating Handbook and FAA Approved Airplane Flight Manual only as set forth below. Users of the manual are advised to always refer to the supplement for possibly superseding information and placarding applicable to operation of the airplane.

LIMITATIONS

No change.

EMERGENCY PROCEDURES

No change.

NORMAL PROCEDURES

No change.

PERFORMANCE

No change.

WEIGHT AND BALANCE

No change.

SYSTEMS DESCRIPTION

LANDING GEAR

WARNING HORN AND (IF INSTALLED BY KIT) GEAR UP ANNUNCIATOR

With the landing gear retracted and the flaps fully extended, a warning horn will sound intermittently and the GEAR UP annunciator (if installed) will flash.

HANDLING, SERVICING, AND MAINTENANCE

No change.

**BEECHCRAFT 33, 35, 36, 55, 58 SERIES
LANDPLANES**

**PILOT'S OPERATING HANDBOOK AND FAA
APPROVED AIRPLANE FLIGHT MANUAL
SUPPLEMENT**

FOR THE

LANDING GEAR WARNING LIGHT SYSTEM

**THIS SUPPLEMENT IS APPLICABLE TO PILOT'S
OPERATING HANDBOOKS AND FAA APPROVED
AIRPLANE FLIGHT MANUALS:**

(SEE NEXT PAGE FOR APPLICABILITY)

Airplane Serial Number: _____

Airplane Registration Number: _____

FAA Approved:



W. H. Schultz
Beech Aircraft Corporation
DOA CE-2

COPYRIGHT © BEECH 1990

FAA Approved
P/N 36-590002-49
Issued: December, 1990

1 of 6

The supplement noted herein applies to the following Pilot's Operating Handbooks and FAA Approved Airplane Flight Manuals:

33-590009-13	F33A Serials CE-748, CE-772 thru CE-1306, except CE-1301 F33C Serials CJ-149 thru CJ-179
35-590118-29	V35B Serials D-10097, D-10120 thru D-10403
36-590002-17	A36 Serials E-1111, E-1241 thru E-2110, except E-1946 and E-2104
36-590002-37	A36 Serials E-1946, E-2104, E-2111 thru E-2467, except E-2458
36-590003-3	A36TC Serials EA-1 thru EA-272, except EA-242
36-590006-3	B36TC Serials EA-242, EA-273 thru EA-388, except EA-320
36-590006-19	B36TC Serials EA-320, EA-389 thru EA-487
96-590011-17	95B55 Serials TC-2003 thru TC-2456
96-590010-17	E55 Serials TE-1084 thru TE-1201
58-590000-21	58 Serials TH-773 thru TH-1395, except TH-1389

58-590000-35

58 Serials TH-1389, TH-1396 thru TH-1471, TH-1476, TH-1487, TH-1489, and TH-1498

58-590000-39

58 Serials TH-1472 thru TH-1475, TH-1477 thru TH-1486, TH-1488, TH-1490 thru TH-1497, TH-1499 thru TH-1542, and TH-1544

CONTENTS

GENERAL	Page 4
LIMITATIONS	Page 4
EMERGENCY PROCEDURES	Page 5
NORMAL PROCEDURES	Page 5
PERFORMANCE	Page 5
WEIGHT & BALANCE	Page 5
SYSTEMS DESCRIPTION	Page 5
HANDLING, SERVICING & MAINTENANCE . . .	Page 6

GENERAL

The information in this supplement is FAA-approved material and must be attached to the Pilot's Operating Handbook and FAA Approved Airplane Flight Manual when the airplane has been modified by installation of the Landing Gear Warning Light System in accordance with Beech Kit Drawing 36-3013.

The information in this supplement supersedes or adds to the basic Pilot's Operating Handbook and FAA Approved Airplane Flight Manual only as set forth below. Users of the manual are advised to always refer to the supplement for possibly superseding information and placarding applicable to operation of the airplane.

LIMITATIONS

KINDS OF OPERATIONS EQUIPMENT LIST

The required items listed below supersede those items listed under "LANDING GEAR" published in the Pilot's Operating Handbook and FAA Approved Airplane Flight Manual:

SYSTEM and/or COMPONENT	VFR DAY	VFR NIGHT	IFR DAY	IFR NIGHT	ICING COND- ITIONS
LANDING GEAR					
1. Emergency Landing Gear Extension System	1	1	1	1	1
2. Landing Gear Position Indicator Lights	4	4	4	4	4
3. Landing Gear Motor and Gearbox	1	1	1	1	1
4. Landing Gear Warning Horn	1	1	1	1	1
5. Gear Up Warning Light	1	1	1	1	1

EMERGENCY PROCEDURES

No change.

NORMAL PROCEDURES

No change.

PERFORMANCE

No change.

WEIGHT AND BALANCE

No change.

SYSTEMS DESCRIPTION

INSTRUMENT PANEL

GEAR-UP WARNING LIGHT SYSTEM

This kit installs a landing gear warning light (GEAR UP) that flashes whenever the gear warning horn sounds. De-

pending upon the particular airplane in which this kit is installed, the light will be located either; (1) as a part of the Glareshield Annunciator Panel or, (2) as a separate light in the glareshield.

The warning annunciators have both a "bright" and "dim" mode of illumination intensity. On some airplanes, certain annunciators do not dim, eg., START, AFT DOOR. On these airplanes, the GEAR UP light (annunciator) also will not dim.

LANDING GEAR SYSTEM

GEAR-UP WARNING LIGHT

A gear-up warning light is installed which will flash whenever the gear-up warning horn sounds. The light is cancelled as the warning horn cancels.

HANDLING, SERVICING, AND MAINTENANCE

No change.

SECTION X
SAFETY INFORMATION
TABLE OF CONTENTS

<i>SUBJECT</i>	<i>PAGE</i>
Introduction	3
General	5.
Do's	5
Don'ts	6
Sources of Information	7
Pilot's Operating Handbook and FAA Approved Airplane Flight Manual	7
BEECHCRAFT Service Publications	7
Federal Aviation Regulations	9
Airworthiness Directives	10
Airman's Information Manual	10
Advisory Information	11
FAA Advisory Circulars	11
FAA General Aviation News	15
FAA Accident Prevention Program	15
Additional Information	16
General Information on Specific Topics	17
Maintenance	17
Hazards of Unapproved Modifications	19
Flight Planning	20
Passenger Information Cards	20
Stowage of Articles	21
Flight Operations	21
General	21
Preflight Inspection	21
Weight and Balance	22
Autopilots and Electric Trim Systems	23
Flutter	26
Turbulent Weather	28
Wind Shear	30
Flight in Icing Conditions	31
Weather Radar	36
Mountain Flying	39
VFR - Low Ceilings	39

SECTION X
SAFETY INFORMATION
TABLE OF CONTENTS (Continued)

<i>SUBJECT</i>	<i>PAGE</i>
VFR at Night	40
Vertigo - Disorientation	40
Flight of Multi-Engine Airplanes With One Engine Inoperative	42
Air Minimum Control Speed (V_{MCA})	44
Intentional One-Engine Inoperative Speed (V_{SSE})	45
One-Engine-Inoperative Best Rate-of-Climb Speed (V_{YSE})	45
One-Engine-Inoperative Best Angle-of-Climb Speed (V_{XSE})	46
Single Engine Service Ceiling	46
Basic Single Engine Procedures	46
Engine Failure on Takeoff	47
When to Fly V_X , V_Y , V_{XSE} and V_{YSE}	48
Stalls, Slow Flight and Training	48
Spins	51
Descent	53
Vortices - Wake Turbulence	54
Takeoff and Landing Conditions	55
Medical Facts for Pilots	55
General	55
Fatigue	56
Hypoxia	56
Hyperventilation	58
Alcohol	59
Drugs	60
Scuba Diving	61
Carbon Monoxide and Night Vision	61
Decompression Sickness	61
A Final Word	63

INTRODUCTION

Beech Aircraft Corporation has developed this special summary publication of safety information to refresh pilots' and owners' knowledge of safety related subjects. Topics in this publication are dealt with in more detail in FAA Advisory Circulars and other publications pertaining to the subject of safe flying.

The skilled pilot recognizes that safety consciousness is an integral - and never-ending - part of his or her job. Be thoroughly familiar with your airplane. Know its limitations and your own. Maintain your currency, or fly with a qualified instructor until you are current and proficient. Practice emergency procedures at safe altitudes and airspeeds, preferably with a qualified instructor pilot, until the required action can be accomplished without reference to the manual. Periodically review this Safety Information as part of your recurring training regimen.

BEECHCRAFT airplanes are designed and built to provide you with many years of safe and efficient transportation. By maintaining your BEECHCRAFT properly and flying it prudently you will realize its full potential.

..... Beech Aircraft Corporation

WARNING

Because your airplane is a high performance, high speed transportation vehicle, designed for operation in a three-dimensional environment, special safety precautions must be observed to reduce the risk of fatal or serious injuries to the pilot(s) and occupant(s).

It is mandatory that you fully understand the contents of this publication and the other operating and maintenance manuals which accompany the airplane; that FAA requirements for ratings, certifications and review be scrupulously complied with; and that you allow only persons who are properly licensed and rated, and thoroughly familiar with the contents of the Pilot's Operating Handbook and FAA Approved Airplane Flight Manual to operate the airplane.

IMPROPER OPERATION OR MAINTENANCE OF AN AIRPLANE, NO MATTER HOW WELL BUILT INITIALLY, CAN RESULT IN CONSIDERABLE DAMAGE OR TOTAL DESTRUCTION OF THE AIRPLANE, ALONG WITH SERIOUS OR FATAL INJURIES TO ALL OCCUPANTS.

GENERAL

As a pilot, you are responsible to yourself and to those who fly with you, to other pilots and their passengers and to people on the ground, to fly wisely and safely.

The following material in this Safety Information publication covers several subjects in limited detail. Here are some condensed Do's and Don'ts.

DO'S

Be thoroughly familiar with your airplane, know its limitations and your own.

Be current in your airplane, or fly with a qualified instructor until you are current. Practice until you are proficient.

Preplan all aspects of your flight - including a proper weather briefing and adequate fuel reserves.

Use services available - weather briefing, inflight weather and Flight Service Station.

Carefully preflight your airplane.

Use the approved checklist.

Have more than enough fuel for takeoff, plus the trip, and an adequate reserve.

Be sure your weight loading and C.G. are within limits.

Use seatbelts and shoulder harnesses at all times.

Be sure all loose articles and baggage are secured.

Check freedom and proper direction of operation of all controls during preflight.

Maintain the prescribed airspeeds in takeoff, climb, descent, and landing.

Avoid wake turbulence (Vortices).

Preplan fuel and fuel tank management before the actual flight. Utilize auxiliary tanks only in level cruise flight. Take off and land on the fullest main tank, NEVER use auxiliary fuel tanks for take off or landing.

Practice emergency procedures at safe altitudes and air-speeds, preferably with a qualified instructor pilot, until the required action is instinctive.

Keep your airplane in good mechanical condition.

Stay informed and alert; fly in a sensible manner.

DON'TS

Don't take off with frost, ice or snow on the airplane.

Don't take off with less than minimum recommended fuel, plus adequate reserves, and don't run the tank dry before switching.

Don't fly in a reckless, show-off, or careless manner.

Don't fly into thunderstorms or severe weather.

Don't fly in possible icing conditions unless the airplane is approved, properly equipped, and all required equipment is operational for flight in icing conditions.

Don't fly close to mountainous terrain.

Don't apply controls abruptly or with high forces that could exceed design loads of the airplane.

Don't fly into weather conditions that are beyond your ratings or current proficiency.

Don't fly when physically or mentally exhausted or below par.

Don't trust to luck.

SOURCES OF INFORMATION

There is a wealth of information available to the pilot created for the sole purpose of making your flying safer, easier and more efficient. Take advantage of this knowledge and be prepared for an emergency in the event that one should occur.

PILOT'S OPERATING HANDBOOK AND FAA APPROVED AIRPLANE FLIGHT MANUAL

You must be thoroughly familiar with the contents of your operating manuals, placards, and check lists to ensure safe utilization of your airplane. When the airplane was manufactured, it was equipped with one or more of the following: placards, Owner's Manual, FAA Flight Manual, Approved Airplane Flight Manual Supplements, Pilot's Operating Handbook and FAA Approved Airplane Flight Manual. Beech has revised and reissued many of the early manuals for certain models of airplanes in GAMA Standard Format as Pilot's Operating Handbooks and FAA Approved Airplane Flight Manuals. For simplicity and convenience, all official manuals in various models are referred to as the Pilot's Operating Handbook and FAA Approved Airplane Flight Manual. If the airplane has changed ownership, the Pilot's Operating Handbook and FAA Approved Airplane Flight Manual may have been misplaced or may not be current. Replacement handbooks may be obtained from any BEECHCRAFT Authorized Outlet.

BEECHCRAFT SERVICE PUBLICATIONS

Beech Aircraft Corporation publishes a wide variety of manuals, service letters, service instructions, service bulletins, safety communiques and other publications for the various models of BEECHCRAFT airplanes. Information on how

to obtain publications relating to your airplane is contained in BEECHCRAFT Service Bulletin number 2001, entitled "General - BEECHCRAFT Service Publications - What is Available and How to Obtain It."

Beech Aircraft Corporation automatically mails original issues and revisions of BEECHCRAFT Service Bulletins (Mandatory, Recommended and Optional), FAA Approved Airplane Flight Manual Supplements, reissues and revisions of FAA Approved Airplane Flight Manuals, Flight Handbooks, Owners Manuals, Pilot's Operating Manuals and Pilot's Operating Handbooks, and original issues and revisions of BEECHCRAFT Safety Communiques to BEECHCRAFT Owner addresses as listed by the FAA Aircraft Registration Branch List and the BEECHCRAFT International Owner Notification Service List. While this information is distributed by Beech Aircraft Corporation, Beech can not make changes in the name or address furnished by the FAA. The owner must contact the FAA regarding any changes to name or address. Their address is: FAA Aircraft Registration Branch (AAC250) P.O. Box 25082, Oklahoma City, OK 73125, Phone (405) 680-2131.

It is the responsibility of the FAA owner of record to ensure that any mailings from Beech are forwarded to the proper persons. Often the FAA registered owner is a bank or financing company or an individual not in possession of the airplane. Also, when an airplane is sold, there is a lag in processing the change in registration with the FAA. If you are a new owner, contact your BEECHCRAFT Authorized Outlet and ensure your manuals are up to date.

Beech Aircraft Corporation provides a subscription service which provides for direct factory mailing of BEECHCRAFT publications applicable to a specific serial number airplane. Details concerning the fees and ordering information for this owner subscription service are contained in Service Bulletin number 2001.

For owners who choose not to apply for a Publications Revision Subscription Service, Beech provides a free Owner

Notification Service by which owners are notified by post card of BEECHCRAFT manual reissues, revisions and supplements which are being issued applicable to the airplane owned. On receipt of such notification, the owner may obtain the publication through a BEECHCRAFT Authorized Outlet. This notification service is available when requested by the owner. This request may be made by using the owner notification request card furnished with the loose equipment of each airplane at the time of delivery, or by a letter requesting this service, referencing the specific airplane serial number owned. Write to :

Supervisor, Special Services
Dept. 52
Beech Aircraft Corporation
P.O. Box 85
Wichita, Kansas 67201-0085

From time to time Beech Aircraft Corporation issues BEECHCRAFT Safety Communiques dealing with the safe operation of a specific series of airplanes, or airplanes in general. It is recommended that each owner/operator maintain a current file of these publications. Back issues of BEECHCRAFT Safety Communiques may be obtained without charge by sending a request, including airplane model and serial number, to the Supervisor, Special Services, at the address listed above.

Airworthiness Directives (AD's) are not issued by the manufacturer. They are issued and available from the FAA.

FEDERAL AVIATION REGULATIONS

FAR Part 91, General Operating and Flight Rules, is a document of law governing operation of airplanes and the owner's and pilot's responsibilities. Some of the subjects covered are:

Responsibilities and authority of the pilot-in-command

Section X
Safety Information

Beechcraft
Twin Engine (Piston)

Certificates required
Liquor and Drugs
Flight plans
Preflight action
Fuel requirements
Flight Rules

Maintenance, preventive maintenance, alterations, inspection and maintenance records

You, as a pilot, have responsibilities under government regulations. The regulations are designed for your protection and the protection of your passengers and the public. Compliance is mandatory.

AIRWORTHINESS DIRECTIVES

FAR Part 39 specifies that no person may operate a product to which an Airworthiness Directive issued by the FAA applies, except in accordance with the requirements of that Airworthiness Directive.

AIRMAN'S INFORMATION MANUAL

The Airman's Information Manual (AIM) is designed to provide airmen with basic flight information and ATC procedures for use in the national airspace system of the United States. It also contains items of interest to pilots concerning health and medical facts, factors affecting flight safety, a pilot/controller glossary of terms in the Air Traffic Control system, information on safety, and accident/hazard reporting. It is revised at six-month intervals and can be purchased from the Superintendent of Documents, U.S. Government Printing Office, Washington, D.C. 20402.

This document contains a wealth of pilot information. Among the subjects are:

Controlled Airspace

Emergency Procedures
Services Available to Pilots
Weather and Icing
Radio Phraseology and Technique
Mountain Flying
Airport Operations
Wake Turbulence - Vortices
Clearances and Separations
Medical Facts for Pilots
Preflight
Bird Hazards
Departures - IFR
Good Operating Practices
Enroute - IFR
Airport Location Directory
Arrival - IFR

All pilots must be thoroughly familiar with and use the information in the AIM.

ADVISORY INFORMATION

NOTAMS (Notices to Airmen) are documents that have information of a time-critical nature that would affect a pilot's decision to make a flight; for example, an airport closed, terminal radar out of service, or enroute navigational aids out of service.

FAA ADVISORY CIRCULARS

The FAA issues Advisory Circulars to inform the aviation public in a systematic way of nonregulatory material of interest. Advisory Circulars contain a wealth of information with which the prudent pilot should be familiar. A complete list of current FAA Advisory Circulars is published in AC 00-2, which lists Advisory Circulars that are for sale, as well as those distributed free of charge by the FAA, and provides

Section X
Safety Information

Beechcraft
Twin Engine (Piston)

ordering information. Many Advisory Circulars which are for sale can be purchased locally in aviation bookstores or at FBO's. These documents are subject to periodic revision. Be certain the Advisory Circular you are using is the latest revision available. Some of the Advisory Circulars of interest to pilots are:

- | | |
|---------------|--|
| *00-6 | Aviation Weather |
| 00-24 | Thunderstorms |
| 00-30 | Rules of Thumb for Avoiding or Minimizing Encounters with Clear Air Turbulence |
| *00-45 | Aviation Weather Services |
| 00-46 | Aviation Safety Reporting Program |
| 20-5 | Plane Sense |
| 20-32 | Carbon Monoxide (CO) Contamination in Aircraft - Detection and Prevention |
| 20-35 | Tie-Down Sense |
| 20-43 | Aircraft Fuel Control |
| 20-105 | Engine-Power Loss Accident Prevention |
| 20-113 | Pilot Precautions and Procedures to be Taken in Preventing Aircraft Reciprocating Engine Induction System and Fuel System Icing Problems |
| 20-125 | Water in Aviation Fuels |
| 21-4 | Special Flight Permits for Operation of Overweight Aircraft |
| 43-9 | Maintenance Records: General Aviation Aircraft |

43-12	Preventive Maintenance
60-4	Pilot's Spatial Disorientation
60-6	Airplane Flight Manuals (AFM), Approved Manual Materials, Markings and Placards - Airplanes
60-12	Availability of Industry-Developed Guidelines for the Conduct of the Bien- nial Flight Review
60-13	The Accident Prevention Counselor Program
*61-9	Pilot Transition Courses for Complex Single-Engine and Light Twin-Engine Airplanes
*61-21	Flight Training Handbook
*61-23	Pilot's Handbook of Aeronautical Knowledge
*61-27	Instrument Flying Handbook
61-67	Hazards Associated with Spins in Air- planes Prohibited from Intentional Spinning.
61-84	Role of Preflight Preparation
*67-2	Medical Handbook for Pilots
90-23	Aircraft Wake Turbulence
90-42	Traffic Advisory Practices at Nontower Airports
90-48	Pilot's Role in Collision Avoidance
90-66	Recommended Standard Traffic Pat- terns for Airplane Operations at Uncontrolled Airports

Section X
Safety Information

Beechcraft
Twin Engine (Piston)

- 90-85** Severe Weather Avoidance Plan (SWAP)
- 91-6** Water, Slush and Snow on the Runway
- 91-13** Cold Weather Operation of Aircraft
- *91-23** Pilot's Weight and Balance Handbook
- 91-26** Maintenance and Handling of Air Driven Gyroscopic Instruments
- 91-33** Use of Alternate Grades of Aviation Gasoline for Grade 80/87
- 91-35** Noise, Hearing Damage, and Fatigue in General Aviation Pilots
- 91-43** Unreliable Airspeed Indications
- 91-44** Operational and Maintenance Practices for Emergency Locator Transmitters and Receivers
- 91-46** Gyroscopic Instruments - Good Operating Practices
- 91-50** Importance of Transponder Operations and Altitude Reporting
- 91-51** Airplane Deice and Anti-ice Systems
- 91-59** Inspection and Care of General Aviation Aircraft Exhaust Systems
- 91-65** Use of Shoulder Harness in Passenger Seats
- 103-4** Hazards Associated with Sublimation of Solid Carbon Dioxide (Dry Ice) Aboard Aircraft
- 135-9** FAR Part 135 Icing Limitations

210-5A

Military Flying Activities

*** For Sale**

FAA GENERAL AVIATION NEWS

FAA General Aviation News is published by the FAA in the interest of flight safety. The magazine is designed to promote safety in the air by calling the attention of general aviation airmen to current technical, regulatory and procedural matters affecting the safe operation of airplanes. FAA General Aviation News is sold on subscription by the Superintendent of Documents, Government Printing Office, Washington D.C., 20402.

FAA ACCIDENT PREVENTION PROGRAM

The FAA assigns accident prevention specialists to each Flight Standards and General Aviation District Office to organize accident prevention program activities. In addition, there are over 3,000 volunteer airmen serving as accident prevention counselors, sharing their technical expertise and professional knowledge with the general aviation community. The FAA conducts seminars and workshops, and distributes invaluable safety information under this program.

Usually the airport manager, the FAA Flight Service Station (FSS), or Fixed Base Operator (FBO), will have a list of accident prevention counselors and their phone numbers available. All Flight Standards and General Aviation District Offices have a list of the counselors serving the District.

Before flying over unfamiliar territory, such as mountainous terrain or desert areas, it is advisable for transient pilots to consult with local counselors. They will be familiar with the more desirable routes, the wind and weather conditions, and the service and emergency landing areas that are available along the way. They can also offer advice on the type of emergency equipment you should be carrying.

ADDITIONAL INFORMATION

The National Transportation Safety Board and the Federal Aviation Administration periodically issue, in greater detail, general aviation pamphlets concerning aviation safety. FAA Regional Offices also publish material under the FAA General Aviation Accident Prevention Program. These can be obtained at FAA Offices, Weather Stations, Flight Service Stations or Airport Facilities. Some of these are titled:

12 Golden Rules for Pilots
Weather or Not
Disorientation
Plane Sense
Weather Info Guide for Pilots
Wake Turbulence
Don't Trust to Luck, Trust to Safety
Rain, Fog, Snow
Thunderstorm - TRW
Icing
Pilot's Weather Briefing Guide
Thunderstorms Don't Flirt ... Skirt 'em
IFR-VFR - Either Way Disorientation Can Be Fatal
IFR Pilot Exam-O-Grams
VFR Pilot Exam-O-Grams
Flying Light Twins Safely
Tips on Engine Operation in Small General Aviation Aircraft
Estimating Inflight Visibility
Is the Aircraft Ready for Flight
Tips on Mountain Flying
Tips on Desert Flying
Always Leave Yourself An Out
Safety Guide for Private Aircraft Owners
Tips on How to Use the Flight Planner
Tips on the Use of Ailerons and Rudder
Some Hard Facts About Soft Landings

Propeller Operation and Care

Torque "What it Means to the Pilot"

Weight and Balance. An Important Safety Consideration for Pilots

GENERAL INFORMATION ON SPECIFIC TOPICS

MAINTENANCE

Safety of flight begins with a well maintained airplane. Make it a habit to keep your airplane and all of its equipment in airworthy condition. Keep a "squawk list" on board, and see that all discrepancies, however minor, are noted and promptly corrected.

Schedule your maintenance regularly, and have your airplane serviced by a reputable organization. Be suspicious of bargain prices for maintenance, repair and inspections.

It is the responsibility of the owner and the operator to assure that the airplane is maintained in an airworthy condition and that proper maintenance records are kept.

Use only genuine BEEHCRAFT or BEEHCRAFT approved parts obtained from BEEHCRAFT approved sources, in connection with the maintenance and repair of Beech airplanes.

Genuine BEEHCRAFT parts are produced and inspected under rigorous procedures to insure airworthiness and suitability for use in Beech airplane applications. Parts purchased from sources other than BEEHCRAFT, even though outwardly identical in appearance, may not have had the required tests and inspections performed, may be different in fabrication techniques and materials, and may be dangerous when installed in an airplane.

Salvaged airplane parts, reworked parts obtained from non-BEECHCRAFT approved sources or parts, components, or structural assemblies, the service history of which is unknown or cannot be authenticated, may have been subjected to unacceptable stresses or temperatures or have other hidden damage not discernible through routine visual or usual nondestructive testing techniques. This may render the part, component or structural assembly, even though originally manufactured by BEECHCRAFT, unsuitable and unsafe for airplane use.

BEECHCRAFT expressly disclaims any responsibility for malfunctions, failures, damage or injury caused by use of non-BEECHCRAFT parts.

Airplanes operated for Air Taxi or other than normal operation, and airplanes operated in humid tropics, or cold and damp climates, etc., may need more frequent inspections for wear, corrosion and/or lack of lubrication. In these areas, periodic inspections should be performed until the operator can set his own inspection periods based on experience.

NOTE

The required periods do not constitute a guarantee that the item will reach the period without malfunction, as the aforementioned factors cannot be controlled by the manufacturer.

Corrosion and its effects must be treated at the earliest possible opportunity. A clean, dry surface is virtually immune to corrosion. Make sure that all drain holes remain unobstructed. Protective films and sealants help to keep corrosive agents from contacting metallic surfaces. Corrosion inspections should be made most frequently under high-corrosion-risk operating conditions, such as in areas of

excessive airborne salt concentrations (e.g., near the sea) and in high-humidity areas (e.g., tropical regions).

If you have purchased a used airplane, have your mechanic inspect the airplane registration records, logbooks and maintenance records carefully. An unexplained period of time for which the airplane has been out of service, or unexplained significant repairs may well indicate the airplane has been seriously damaged in a prior accident. Have your mechanics inspect a used airplane carefully. Take the time to ensure that you really know what you are buying when you buy a used airplane.

HAZARDS OF UNAPPROVED MODIFICATIONS

Many airplane modifications are approved under Supplemental Type Certificates (STC's). Before installing an STC on your airplane, check to make sure that the STC does not conflict with other STC's that have already been installed. Because approval of an STC is obtained by the individual STC holder based upon modification of the original type design, it is possible for STC's to interfere with each other when both are installed. Never install an unapproved modification of any type, however innocent the apparent modification may seem. Always obtain proper FAA approval.

Airplane owners and maintenance personnel are particularly cautioned not to make attachments to, or otherwise modify, seats from original certification without approval from the FAA Engineering and Manufacturing District Office having original certification responsibility for that make and model.

Any unapproved attachment or modification to seat structure may increase load factors and metal stress which could cause failure of seat structure at a lesser "G" force than exhibited for original certification.

Examples of unauthorized attachments found are drilling holes in seat tubing to attach fire extinguishers and drilling holes to attach approach plate book bins to seats.

FLIGHT PLANNING

FAR Part 91 requires that each pilot in command, before beginning a flight, familiarize himself with all available information concerning that flight.

Obtain a current and complete preflight briefing. This should consist of local, enroute and destination weather and enroute navaid information. Enroute terrain and obstructions, alternate airports, airport runways active, length of runways, and takeoff and landing distances for the airplane for conditions expected should be known.

The prudent pilot will review his planned enroute track and stations and make a list for quick reference. It is strongly recommended a flight plan be filed with Flight Service Stations, even though the flight may be VFR. Also, advise Flight Service Stations of changes or delays of one hour or more and remember to close the flight plan at destination.

The pilot must be completely familiar with the performance of the airplane and performance data in the Pilot's Operating Handbook and FAA Approved Airplane Flight Manual. The resultant effect of temperature and pressure altitude must be taken into account in performance if not accounted for on the charts. An applicable FAA Approved Airplane Flight Manual must be aboard the airplane at all times and include the weight and balance forms and equipment list.

PASSENGER INFORMATION CARDS

Beech has available, for most current production airplanes, passenger information cards which contain important information on the proper use of restraint systems, oxygen

masks, emergency exits and emergency bracing procedures. Passenger information cards may be obtained at any BEECHCRAFT Authorized Outlet. A pilot should not only be familiar with the information contained in the cards, but should always, prior to flight, inform the passengers of the information contained in the information cards. The pilot should orally brief the passengers on the proper use of restraint systems, doors and emergency exits, and other emergency procedures, as required by Part 91 of the FAR's.

STOWAGE OF ARTICLES

The space between the seat pan and the floor is utilized to provide space for seat displacement. If hard, solid objects are stored beneath seats, the energy absorbing feature is lost and severe spinal injuries can occur to occupants.

Prior to flight, pilots should insure that articles are not stowed beneath seats that would restrict seat pan energy absorption or penetrate the seat in event of a high vertical velocity accident.

FLIGHT OPERATIONS

GENERAL

The pilot **MUST** be thoroughly familiar with **ALL INFORMATION** published by the manufacturer concerning the airplane, and is required by law to operate the airplane in accordance with the FAA Approved Airplane Flight Manual and placards installed.

PREFLIGHT INSPECTION

In addition to maintenance inspections and preflight information required by FAR Part 91, a complete, careful preflight inspection is imperative.

Each airplane has a checklist for the preflight inspection which must be followed. USE THE CHECKLIST.

WEIGHT AND BALANCE

Maintaining center of gravity within the approved envelope throughout the planned flight is an important safety consideration.

The airplane must be loaded so as not to exceed the weight and center of gravity (C.G.) limitations. Airplanes that are loaded above the maximum takeoff or landing weight limitations will have an overall lower level of performance compared to that shown in the Performance section of the Pilot's Operating Handbook and FAA Approved Airplane Flight Manual. If loaded above maximum takeoff weight, takeoff distance and the landing distance will be longer than that shown in the Performance section; the stalling speed will be higher, rate of climb, the cruising speed, and the range of the airplane at any level of fuel will all be lower than shown in the Performance section.

If an airplane is loaded so that the C.G. is forward of the forward limit it will require additional control movements for maneuvering the airplane with correspondingly higher control forces. The pilot may have difficulty during takeoff and landing because of the elevator control limits.

If an airplane is loaded aft of the aft C.G. limitation, the pilot will experience a lower level of stability. Airplane characteristics that indicate a lower stability level are; lower control forces, difficulty in trimming the airplane, lower control forces for maneuvering with attendant danger of structural overload, decayed stall characteristics, and a lower level of lateral-directional damping.

Ensure that all cargo and baggage is properly secured before takeoff. A sudden shift in balance at rotation can cause controllability problems.

AUTOPILOTS AND ELECTRIC TRIM SYSTEMS

Because there are several different models of autopilots and electric trim systems installed in Beech airplanes and different installations and switch positions are possible from airplane to airplane, it is essential that every owner/operator review his Airplane Flight Manual (AFM) Supplements and ensure that the supplements properly describe the autopilot and trim installations on his specific airplane. Each pilot, prior to flight, must be fully aware of the proper procedures for operation, and particularly disengagement, for the system as installed.

In addition to ensuring compliance with the autopilot manufacturer's maintenance requirements, all owners/operators should thoroughly familiarize themselves with the operation, function and procedures described in the Airplane Flight Manual Supplements. Ensure a full understanding of the methods of engagement and disengagement of the autopilot and trim systems.

Compare the descriptions and procedures contained in the Supplements to the actual installation in the airplane to ensure that the supplement accurately describes your installation. Test that all buttons, switches and circuit breakers function as described in the Supplements. If they do not function as described, have the system repaired by a qualified service agency. If field service advice or assistance is necessary, contact Beech Aircraft Corporation, Customer Support Department.

As stated in all AFM Supplements for autopilot systems and trim systems installed on Beech airplanes, the preflight check must be conducted before every flight. The preflight check assures not only that the systems and all of their features are operating properly, but also that the pilot, before flight, is familiar with the proper means of engagement and disengagement of the autopilot and trim system.

Autopilot Airplane Flight Manual Supplements caution against trying to override the autopilot system during flight without disengaging the autopilot because the autopilot will continue to trim the airplane and oppose the pilot's actions. This could result in a severely out of trim condition. This is a basic feature of all autopilots with electric trim follow-up.

Do not try to manually override the autopilot during flight.

IN CASE OF EMERGENCY, YOU CAN OVERPOWER THE AUTOPILOT TO CORRECT THE ATTITUDE, BUT THE AUTOPILOT AND ELECTRIC TRIM MUST THEN IMMEDIATELY BE DISENGAGED.

It is often difficult to distinguish an autopilot malfunction from an electric trim system malfunction. The safest course is to deactivate both. Do not re-engage either system until after you have safely landed. Then have the systems checked by a qualified service facility prior to further flight.

Depending upon the installation on your airplane, the following additional methods may be available to disengage the autopilot or electric trim in the event that the autopilot or electric trim does not disengage utilizing the disengage methods specified in the Supplements.



Transient control forces may occur when the autopilot is disengaged.

1. Turn off the autopilot master switch, if installed.
2. Pull the autopilot and trim circuit breaker(s) or turn off the autopilot switch breaker, if installed.
3. Turn off the RADIO MASTER SWITCH, if installed, and

if the autopilot system and the trim system are wired through this switch.



Radios, including VHF COMM are also disconnected when the radio master switch is off.

4. Turn off the ELECTRIC MASTER SWITCH.



Most electrically powered systems will be inoperative. Consult the AFM for further information.

5. Push the GA switch on throttle grip, if installed (depending upon the autopilot system).
6. Push TEST EACH FLT switch on the autopilot controller, if installed.

NOTE

After the autopilot is positively disengaged, it may be necessary to restore other electrical functions. Be sure when the master switches are turned on that the autopilot does not re-engage.

The above ways may or may not be available on your autopilot. It is essential that you read your airplane's AFM

SUPPLEMENT for your autopilot system and check each function and operation on your system.

The engagement of the autopilot must be done in accordance with the instructions and procedures contained in the AFM SUPPLEMENT.

Particular attention must be paid to the autopilot settings prior to engagement. If you attempt to engage the autopilot when the airplane is out of trim, a large attitude change may occur.

IT IS ESSENTIAL THAT THE PROCEDURES SET FORTH IN THE APPROVED AFM SUPPLEMENTS FOR YOUR SPECIFIC INSTALLATION BE FOLLOWED BEFORE ENGAGING THE AUTOPILOT.

FLUTTER

Flutter is a phenomenon that can occur when an aerodynamic surface begins vibrating. The energy to sustain the vibration is derived from airflow over the surface. The amplitude of the vibration can (1) decrease, if airspeed is reduced; (2) remain constant, if airspeed is held constant and no failures occur; or (3) increase to the point of self-destruction, especially if airspeed is high and/or is allowed to increase. Flutter can lead to an in-flight break up of the airplane. Airplanes are designed so that flutter will not occur in the normal operating envelope of the airplane as long as the airplane is properly maintained. In the case of any airplane, decreasing the damping and stiffness of the structure or increasing the trailing edge weight of control surfaces will tend to cause flutter. If a combination of those factors is sufficient, flutter can occur within the normal operating envelope.

Owners and operators of airplanes have the primary responsibility for maintaining their airplanes. To fulfill that responsibility, it is imperative that all airplanes receive a thorough

preflight inspection. Improper tension on the control cables or any other loose condition in the flight control system can also cause or contribute to flutter. Pilots should pay particular attention to control surface attachment hardware including tab pushrod attachment during preflight inspection. Looseness of fixed surfaces or movement of control surfaces other than in the normal direction of travel should be rectified before flight. Further, owners should take their airplanes to mechanics who have access to current technical publications and prior experience in properly maintaining that make and model of airplane. The owner should make certain that control cable tension inspections are performed as outlined in the applicable Beech Inspection Guide. Worn control surface attachment hardware must be replaced. Any repainting or repair of a moveable control surface will require a verification of the control surface balance before the airplane is returned to service. Control surface drain holes must be open to prevent freezing of accumulated moisture, which could create an increased trailing-edge-heavy control surface and flutter.

If an excessive vibration, particularly in the control column and rudder pedals, is encountered in flight, this may be the onset of flutter and the procedure to follow is:

1. IMMEDIATELY REDUCE AIRSPEED (lower the landing gear, if necessary).
2. RESTRAIN THE CONTROLS OF THE AIRPLANE UNTIL THE VIBRATION CEASES.
3. FLY AT THE REDUCED AIRSPEED AND LAND AT THE NEAREST SUITABLE AIRPORT.
4. HAVE THE AIRPLANE INSPECTED FOR AIRFRAME DAMAGE, CONTROL SURFACE ATTACHING HARDWARE CONDITION/SECURITY, TRIM TAB FREE PLAY, PROPER CONTROL CABLE TENSION, AND CONTROL SURFACE BALANCE BY ANOTHER MECHANIC WHO IS FULLY QUALIFIED.

TURBULENT WEATHER

A complete and current weather briefing is a requirement for a safe trip.

Updating of weather information en route is also essential. The wise pilot knows that weather conditions can change quickly, and treats weather forecasting as professional advice, rather than an absolute fact. He obtains all the advice he can, but stays alert to any sign or report of changing conditions.

Plan the flight to avoid areas of reported severe turbulence. It is not always possible to detect individual storm areas or find the in-between clear areas.

The National Weather Service classifies turbulence as follows:

Class of Turbulence	Effect
Extreme	Airplane is violently tossed about and is practically impossible to control. May cause structural damage.
Severe	Airplane may be momentarily out of control. Occupants are thrown violently against the belts and back into the seat. Unsecured objects are tossed about.
Moderate	Occupants require seat belts and occasionally are thrown against the belt. Unsecured objects move about.

Light Occupants may be required to use seat belts, but objects in the airplane remain at rest.

Thunderstorms, squall lines and violent turbulence should be regarded as extremely dangerous and must be avoided. Hail and tornadic wind velocities can be encountered in thunderstorms that can destroy any airplane, just as tornadoes destroy nearly everything in their path on the ground.

Thunderstorms also pose the possibility of a lightning strike on an airplane. Any structure or equipment which shows evidence of a lightning strike, or of being subjected to a high current flow due to a strike, or is a suspected part of a lightning strike path through the airplane should be thoroughly inspected and any damage repaired prior to additional flight.

A roll cloud ahead of a squall line or thunderstorm is visible evidence of extreme turbulence; however, the absence of a roll cloud should not be interpreted as denoting that severe turbulence is not present.

Even though flight in severe turbulence must be avoided, flight in turbulent air may be encountered unexpectedly under certain conditions.

The following recommendations should be observed for airplane operation in turbulent air:

Flying through turbulent air presents two basic problems, the answer to both of which is proper airspeed. On one hand, if you maintain an excessive airspeed, you run the risk of structural damage or failure; on the other hand, if your airspeed is too low, you may stall.

If turbulence is encountered, reduce speed to the turbulent air penetration speed, if given, or to the maneuvering speed, which is listed in the Limitations section of the Pilot's Operating Handbook and FAA Approved Airplane Flight Manual.

These speeds give the best assurance of avoiding excessive stress loads, and at the same time provide the proper margin against inadvertent stalls due to gusts.

Beware of overcontrolling in an attempt to correct for changes in attitude; applying control pressure abruptly will build up G-forces rapidly and could cause structural damage or even failure. You should watch particularly your angle of bank, making turns as wide and shallow as possible. Be equally cautious in applying forward or back pressure to keep the airplane level. Maintain straight and level attitude in either up or down drafts. Use trim sparingly to avoid being grossly out of trim as the vertical air columns change velocity and direction. If necessary to avoid excessive airspeeds, lower the landing gear.

WIND SHEAR

Wind shears are rapid, localized changes in wind direction, which can occur vertically as well as horizontally. Wind shear can be very dangerous to all airplanes, large and small, particularly on approach to landing when airspeeds are slow.

A horizontal wind shear is a sudden change in wind direction or speed that can, for example, transform a headwind into a tailwind, producing a sudden decrease in indicated airspeed because of the inertia of the airplane. A vertical wind shear, is a sudden updraft or downdraft. Microbursts are intense, highly localized severe downdrafts.

The prediction of wind shears is far from an exact science. Monitor your airspeed carefully when flying near storms, particularly on approach. Be mentally prepared to add power and go around at the first indication that a wind shear is being encountered.

FLIGHT IN ICING CONDITIONS

Every pilot should be intimately acquainted with the FAA Approved National Weather Service definitions for ice intensity and accumulation which we have reprinted below:

Intensity	Ice Accumulation
Trace	Ice becomes perceptible. Rate of accumulation slightly greater than rate of sublimation. It is not hazardous even though deicing/anti-icing equipment is not utilized, unless encountered for an extended period of time (over 1 hour).
Light	The rate of accumulation may create a problem if flight is prolonged in this environment (over 1 hour). Occasional use of deicing/anti-icing equipment removes/prevents accumulation. It does not present a problem if the deicing/anti-icing equipment is used.
Moderate	The rate of accumulation is such that even short encounters become potentially hazardous and use of deicing/anti-icing equipment or diversion is necessary.
Severe	The rate of accumulation is such that deicing/anti-icing equipment fails to reduce or control the hazard. Immediate diversion is necessary.

It is no longer unusual to find deicing and anti-icing equipment on a wide range of airplane sizes and types. Since the capability of this equipment varies, it becomes the pilot's primary responsibility to understand limitations which restrict the use of his airplane in icing conditions and the conditions which may exceed the systems capacity.

Pilots and airplane owners must carefully review the Pilot's Operating Handbook and FAA Approved Airplane Flight Manual in order to ascertain the required operable equipment needed for flight in icing conditions. In addition, they must ascertain from the same source the limits of approval or certification of their airplane for flight in icing conditions, and plan the flight accordingly, if icing conditions are known or forecast along the route.

Every owner and pilot of an airplane should understand that it is not uncommon to find airplanes equipped with less than the full complement of available systems and equipment. For example, propellers and pitot tube may be protected, but the airplane may not have wing boots or tail boots. The reverse might be true. Windshield, pitot and airfoil surfaces might be protected, but the propellers might not be. Before undertaking any flight into areas where icing conditions might be expected, inspect the airplane and review the Pilot's Operating Handbook and FAA Approved Airplane Flight Manual to be certain that you are supported by the full complement of required IFR and deicing/anti-icing equipment.

Remember that regardless of its combination of deicing/anti-icing equipment, any airplane not fully equipped and functional for IFR flight is not properly equipped for flight in icing conditions. An airplane which is not approved or certificated for flight in icing conditions, or which does not have all critical areas protected in the required manner by fully operational anti-icing equipment must not be exposed to icing encounters of any intensity. When icing is detected, the pilot of such an airplane must make an immediate diversion by flying out of the area of visible moisture or going to an altitude where icing is not encountered.

Some models of Beech airplanes were approved for flight in certain limited icing conditions under the FAA's Bureau of Flight Standards Release No. 434. Under this release, properly equipped airplanes are approved for flight in light to

moderate icing conditions only. Refer to Sections 2 and 4 of the above document for icing limitations. These airplanes are not approved for extended flight in moderate icing conditions or flights in any severe icing conditions. Flight in these conditions must be avoided.

Even airplanes fully equipped and certified for flight in the icing conditions described in Appendix C to FAR Part 25 must avoid flights into those conditions defined by the National Weather Service as "Severe". The National Weather Service definition of "Severe Icing" describes that conditions as: "the rate of accumulation is such that deicing/anti-icing equipment fails to reduce or control the hazard." No airplane equipped with any combination of deicing/anti-icing equipment can be expected to cope with such conditions. As competent pilots know, there appears to be no predictable limits for the severest weather conditions. For essentially the same reasons that airplanes, however designed or equipped for IFR flight, cannot be flown safely into conditions such as thunderstorms, tornadoes, hurricanes or other phenomena likely to produce severe turbulence, airplanes equipped for flight in icing conditions cannot be expected to cope with "Severe" icing conditions as defined by the National Weather Service. The prudent pilot must remain alert to the possibility that icing conditions may become "severe" and that his equipment will not cope with them. At the first indication that such condition may have been encountered or may lie ahead, he should immediately react by selecting the most expeditious and safe course for diversion.

Every pilot of a properly fully-equipped Beech airplane who ventures into icing conditions must maintain the minimum speed (KIAS) for operation in icing conditions, which is set forth in the Normal Procedures section, and in the Limitations section, of his Pilot's Operating Handbook and FAA Approved Airplane Flight Manual. If a minimum speed for flight in icing conditions is not specified in the manual, the following minimum indicated airspeeds must be maintained:

Section X
Safety Information

Beechcraft
Twin Engine (Piston)

All Baron and Travel Air Models - 130 KIAS

All other BEECHCRAFT twin-engine models - 140 KIAS

The pilot must remain aware of the fact that if he allows his airspeed to deteriorate below this minimum speed, he will increase the angle of attack of his airplane to the point where ice may build up on the under side of the wings aft of the area protected by the boots.

The fact or extent of ice build-up in unprotected areas will not be directly observable from the cockpit. Due to distortion of the wing airfoil, increased drag and reduced lift, stalling speeds will increase as ice accumulates on the airplane. For the same reasons, stall warning devices are not accurate and cannot be relied upon in icing conditions.

Even though the pilot maintains the prescribed minimum speeds for operating in icing conditions, ice is still likely to build up on the unprotected areas (the fuselage and unprotected wing leading edge inboard of the engine nacelle). Under some atmospheric conditions, it may even build up aft of the boots despite the maintenance of the prescribed minimum speed. The effect of ice accumulation on any unprotected surface is aggravated by length of exposure to the icing conditions. Ice buildup on unprotected surfaces will increase drag, add weight, reduce lift, and generally, adversely affect the aerodynamic characteristics and performance of the airplane. It can progress to the point where the airplane is no longer capable of flying. Therefore, the pilot operating even a fully-equipped airplane in sustained icing conditions must remain sensitive to any indication, such as observed ice accumulation, loss of airspeed, the need for increased power, reduced rate of climb, or sluggish response, that ice is accumulating on unprotected surfaces and that continued flight in these conditions is extremely hazardous, regardless of the performance of the deicing/anti-icing equipment.

Since flight in icing conditions is not an everyday occurrence, it is important that pilots maintain a proper proficiency and awareness of the operating procedures necessary for safe operation of the airplane and that the airplane is in a condition for safe operation.

Ensure moisture drains in the airplane structure are maintained open as specified in the Aircraft Maintenance Manual, so that moisture will not collect and cause freezing in the control cable area. Also, control surface tab hinges should be maintained and lubricated as specified in the Aircraft Maintenance Manual.

In icing conditions the autopilot should be disengaged at an altitude sufficient to permit the pilot to gain the feel of the airplane prior to landing. In no case should this be less than the minimum altitude specified in the Autopilot Airplane Flight Manual Supplement.

Observe the procedures set forth in your Pilot's Operating Handbook and FAA Approved Airplane Flight Manual during operation in icing conditions.

Activate your deice and anti-icing systems before entering an area of moisture where you are likely to go through a freezing level, to make sure all necessary equipment is operative.

Rapid cycling of deice boots or cycling before at least one-half inch (1/2") of ice has accumulated (measured in the chordwise direction or forward from the leading edge), may cause the ice to grow outside the contour of the inflated boots and prevent ice removal.

For any owner or pilot whose use pattern for an airplane exposes it to icing encounters, the following references are required reading for safe flying:

- The airplane's Pilot's Operating Handbook and FAA

Approved Airplane Flight Manual, especially the sections on Normal Procedures, Emergency Procedures, Abnormal Procedures, Systems, and Safety Information.

- FAA Advisory Circulars 91-51 Airplane Deice and Anti-ice Systems
- FAA Advisory Circulars 135-9 - Icing Limitations
- Weather Flying by Robert N. Buck.

Finally, the most important ingredients to safe flight in icing conditions - regardless of the airplane or the combination of deicing/anti-icing equipment - are a complete and current weather briefing, sound pilot judgement, close attention to the rate and type of ice accumulations, and the knowledge that "severe icing" as defined by the National Weather Service is beyond the capability of modern airplanes and immediate diversion must be made. It is the inexperienced or uneducated pilot who presses on "regardless", hoping that steadily worsening conditions will improve, only to find himself flying an airplane which has become so loaded with ice that he can no longer maintain altitude. At this point he has lost most, if not all, of his safety options, including perhaps a 180 degree turn to return along the course already traveled.

The responsible and well-informed pilot recognizes the limitations of weather conditions, his airplane and its systems, and reacts promptly.

WEATHER RADAR

Airborne weather avoidance radar is, as its name implies, for avoiding severe weather--not for penetrating it. Whether to fly into an area of radar echoes depends on echo intensity and shape, spacing between the echoes, and the capabilities of you and your airplane. Remember that weather radar detects only precipitation drops. Therefore, the radar scope provides no assurance of avoiding turbulence. The radar scope also does not provide assurance of avoiding

instrument weather from clouds and fog. Your scope may be clear between intense echoes; this clear area does not necessarily mean you can fly between the storms and maintain visual sighting of them.

Thunderstorms build and dissipate rapidly. Therefore, do not attempt to plan a course between echoes using ground based radar. The best use of ground radar information is to isolate general areas and coverage of echoes. You must avoid individual storms from in-flight observations either by visual sighting or by airborne radar. It is better to avoid the whole thunderstorm area than to detour around individual storms unless they are scattered.

Remember that while hail always gives a radar echo, it may fall several miles from the nearest visible cloud and hazardous turbulence may extend to as much as 20 miles from the echo edge. The intensity of the radar echo from hail varies with the size and nature of the hailstone. A hailstone with a wet surface gives a strong radar return while a dry hailstone gives a relatively weak return. Avoid intense or extreme level echoes by at least 20 miles; that is, such echoes should be separated by at least 40 miles before you fly between them. With weaker echoes you can reduce the distance by which you avoid them.

Above all, remember this: never regard any thunderstorm lightly. Even when radar observers report the echoes are of light intensity, avoiding thunderstorms is the best policy. The following are some do's and don'ts of thunderstorm avoidance:

1. Don't land or take off in the face of an approaching thunderstorm. A sudden gust front of low level turbulence could cause loss of control.
2. Don't attempt to fly under a thunderstorm even if you can see through to the other side. Turbulence and wind shear under the storm could be disastrous.

Section X
Safety Information

Beechcraft
Twin Engine (Piston)

3. Don't fly without airborne radar into a cloud mass containing scattered embedded thunderstorms. Embedded thunderstorms usually can not be visually circumnavigated.
4. Don't trust visual appearance to be a reliable indicator of the turbulence inside a thunderstorm.
5. Do avoid by at least 20 miles any thunderstorm identified as severe or giving an intense radar echo. This is especially true under the anvil of a large cumulonimbus.
6. Do circumnavigate the entire area if the area has 6/10 or greater thunderstorm coverage.
7. Do remember that vivid and frequent lightning indicates the probability of a severe thunderstorm.
8. Do regard as extremely hazardous any thunderstorm with tops 35,000 feet or higher, whether the top is visually sighted or determined by radar.

If you cannot avoid penetrating a thunderstorm, the following are some do's BEFORE entering the storm:

9. Tighten your safety belt, put on your shoulder harness, and secure all loose objects.
10. Plan and hold your course to take you through the storm in minimum time.
11. To avoid the most critical icing, establish a penetration altitude below the freezing level or above the level of -15°C.
12. Verify that pitot heat is on and turn on carburetor heat or engine anti-ice. Icing can be rapid at any altitude and cause almost instantaneous power failure and/or loss of airspeed indication.

MOUNTAIN FLYING

Pilots flying in mountainous areas should inform themselves of all aspects of mountain flying, including the effects of topographic features on weather conditions. Many good articles have been published, and a synopsis of mountain flying operations is included in the FAA Airman's Information Manual, Part 1.

Avoid flight at low altitudes over mountainous terrain, particularly near the lee slopes. If the wind velocity near the level of the ridge is in excess of 25 knots and approximately perpendicular to the ridge, mountain wave conditions are likely over and near the lee slopes. If the wind velocity at the level of the ridge exceeds 50 knots, a strong mountain wave is probable with extreme up and down drafts and severe turbulence. The worst turbulence will be encountered in and below the rotor zone, which is usually 8 to 10 miles downwind from the ridge. This zone is sometimes characterized by the presence of "roll clouds" if sufficient moisture is present; altocumulus standing lenticular clouds are also visible signs that a mountain wave exists, but their presence is likewise dependent on moisture. Mountain wave turbulence can, of course, occur in dry air and the absence of such clouds should not be taken as assurance that mountain wave turbulence will not be encountered. A mountain wave downdraft may exceed the climb capability of your airplane. Avoid mountain wave downdrafts.

VFR - LOW CEILINGS

If you are not instrument rated, do not attempt "VFR on Top" or "Special VFR" flight or clearances. Being caught above a solid cloud layer when an emergency descent is required (or at destination) is an extremely hazardous position for the VFR pilot. Accepting a clearance out of airport control zones with no minimum ceiling and one-mile visibility as permitted with "Special VFR" is a foolish practice for the VFR pilot.

Avoid areas of low ceilings and restricted visibility unless you are instrument rated and proficient and have an instrument equipped airplane. Then proceed with caution and with planned alternates.

VFR AT NIGHT

When flying VFR at night, in addition to the altitude appropriate for the direction of flight, pilots should maintain a safe minimum altitude as dictated by terrain, obstacles such as TV towers, or communities in the area flown. This is especially true in mountainous terrain, where there is usually very little ground reference. Minimum clearance is 2,000 feet above the highest obstacle en route. Do not depend on your ability to see obstacles in time to miss them. Flight on dark nights over sparsely populated country can be the same as IFR, and must be avoided by inexperienced or non-IFR rated pilots.

VERTIGO - DISORIENTATION

Disorientation can occur in a variety of ways. During flight, inner ear balancing mechanisms are subjected to varied forces not normally experienced on the ground. This, combined with loss of outside visual reference, can cause vertigo. False interpretations (illusions) result, and may confuse the pilot's conception of the attitude and position of his airplane.

Under VFR conditions, the visual sense, using the horizon as a reference, can override the illusions. Under low visibility conditions (night, fog, clouds, haze, etc.) the illusions predominate. Only through awareness of these illusions, and proficiency in instrument flight procedures, can an airplane be operated safely in a low visibility environment.

Flying in fog, dense haze or dust, cloud banks, or very low visibility, with strobe lights or rotating beacons turned on can

contribute to vertigo. They should be turned off in these conditions, particularly at night.

All pilot's should check the weather and use good judgment in planning flights. The VFR pilot should use extra caution in avoiding low visibility conditions.

Motion sickness often precedes or accompanies disorientation and may further jeopardize the flight.

Disorientation in low visibility conditions is not limited to VFR pilots. Although IFR pilots are trained to look at their instruments to gain an artificial visual reference as a replacement for the loss of a visual horizon, they do not always do so. This can happen when the pilot's physical condition will not permit him to concentrate on his instruments; when the pilot is not proficient in flying instrument conditions in the airplane he is flying; or, when the pilot's work load of flying by reference to his instruments is augmented by such factors as turbulence. Even an instrument rated pilot encountering instrument conditions, intentional or unintentional, should ask himself whether or not he is sufficiently alert and proficient in the airplane he is flying, to fly under low visibility conditions and in the turbulence anticipated or encountered.

If any doubt exists, the flight should not be made or it should be discontinued as soon as possible.

The result of vertigo is loss of control of the airplane. If the loss of control is sustained, it will result in an excessive speed accident. Excessive speed accidents occur in one of two manners, either as an inflight airframe separation or as a high speed ground impact; and they are fatal accidents in either case. All airplanes are subject to this form of accident.

For years, Beech Pilot's Operating Handbooks and FAA Approved Airplane Flight Manuals have contained instructions that the landing gear should be extended in any circumstance in which the pilot encounters IFR conditions

which approach the limits of his capability or his ratings. Lowering the gear in IFR conditions or flight into heavy or severe turbulence, tends to stabilize the airplane, assists in maintaining proper airspeed, and will substantially reduce the possibility of reaching excessive airspeeds with catastrophic consequences, even where loss of control is experienced.

Excessive speed accidents occur at airspeeds greatly in excess of two operating limitations which are specified in the manuals: Maximum maneuvering speed and the "red line" or maximum operating speed. Such speed limits are set to protect the structure of an airplane. For example, flight controls are designed to be used to their fullest extent only below the airplane's maximum maneuvering speed. As a result, the control surfaces should never be suddenly or fully deflected above maximum maneuvering speed. Turbulence penetration should not be performed above that speed. The accidents we are discussing here occur at airspeeds greatly in excess of these limitations. No airplane should ever be flown beyond its FAA approved operating limitations.

FLIGHT OF MULTI-ENGINE AIRPLANES WITH ONE ENGINE INOPERATIVE

The major difference between flying a twin-engine and single-engine airplane is knowing how to manage the flight if one engine loses power for any reason. Safe flight with one engine inoperative requires an understanding of the basic aerodynamics involved - as well as proficiency in engine out procedures.

Loss of power from one engine affects both climb performance and controllability of twin-engine airplanes. Climb performance depends on an excess of power over that required for level flight. Loss of power from one engine obviously represents a 50% loss of horsepower but, in virtually all twin-engine airplanes, climb performance is reduced by at least 80%. A study of the charts in your Pilot's Operating

Handbook and FAA Approved Airplane Flight Manual will confirm this fact. Single-engine climb performance depends on four factors:

Airspeed	too little, or too much, will decrease climb performance
Drag	gear, flaps, cowl flaps, prop, and speed
Power	amount available in excess of that needed for level flight
Weight	passengers, baggage, and fuel load greatly affect climb performance

Loss of power on one engine creates yaw due to asymmetric thrust. Yaw forces must be balanced with the rudder. Loss of power on one engine also reduces airflow over the wing causing a roll toward the "dead" engine which must be balanced with the aileron. The net result of these forces cause the airplane to sideslip slightly toward the dead engine. This sideslip may be balanced by banking slightly (up to 5°) into the operating engine.



In the event of an engine failure with the main tanks less than one-quarter full, corrective action must be taken immediately to prevent large yaw angles from developing and causing stoppage of the remaining engine.

Airspeed is the key to safe single engine operations. For most twin-engine airplanes there is:

Symbol	Description
V_{MCA}	Airspeed below which directional control cannot be maintained
V_{SSE}	Airspeed below which an intentional engine cut should never be made
V_{YSE}	Airspeed that will give the best single engine rate-of-climb (or the slowest loss of altitude)
V_{XSE}	Airspeed that will give the steepest angle-of-climb with one engine out

AIR MINIMUM CONTROL SPEED (V_{MCA})

V_{MCA} is designated by the red radial on the airspeed indicator and indicates the minimum control speed, airborne at sea level. V_{MCA} is determined by FAA regulations as the minimum airspeed at which it is possible to recover directional control of the airplane within 20 degrees heading change, and thereafter maintain straight flight, with not more than 5 degrees of bank if one engine fails suddenly with:

- Takeoff power on both engines
- Rearmost allowable center of gravity
- Flaps in takeoff position
- Propeller windmilling in takeoff pitch configuration

However, sudden engine failures rarely occur with all factors listed above, and therefore, the actual V_{MCA} in any particular situation may be a little slower than the red radial on the airspeed indicator. Most airplanes with an inoperative engine will not maintain level flight at maximum power at speeds at or near V_{MCA} . Consequently, it is not advisable to fly at speeds approaching V_{MCA} , except in training situations or during flight tests. Adhering to the practice of never flying at or below the published V_{MCA} speed for your airplane does not eliminate loss of directional control as a problem in the

event of an engine failure. The pilot must be prepared to use assertive control input to maintain airplane control following an engine failure.

***INTENTIONAL ONE-ENGINE INOPERATIVE
SPEED (V_{SSE})***

V_{SSE} is specified by the airplane manufacturer and is the minimum speed at which to perform intentional engine cuts. Use of V_{SSE} is intended to reduce the accident potential from loss of control after engine cuts at or near minimum control speed. V_{MCA} demonstrations are necessary in training but should only be made at safe altitude above the terrain and with power reduction on one engine made at or above V_{SSE} .

***ONE-ENGINE-INOPERATIVE BEST
RATE-OF-CLIMB SPEED (V_{YSE})***

V_{YSE} is designated by the blue radial on the airspeed indicator. V_{YSE} delivers the greatest gain in altitude in the shortest possible time, and is based on the following criteria:

- Critical engine inoperative, and its propeller in the minimum drag position.
- Operating engine set at not more than the maximum continuous power.
- Landing gear retracted.
- Wing flaps up.
- Cowl flaps as required for engine cooling.
- Airplanes flown at recommended bank angle (up to 5° into operating engine).

Drag caused by a windmilling propeller, extending landing gear, or flaps in the landing position, will severely degrade or destroy single engine climb performance. Since climb

performance varies widely with type of airplane, weight, temperature, altitude, and airplane configuration, the climb gradient (altitude gain or loss per mile) may be marginal - or even negative - under some conditions. Study the Pilot's Operating Handbook and FAA Approved Airplane Flight Manual for your airplane and know what performance to expect with one engine out.

ONE-ENGINE-INOPERATIVE BEST ANGLE-OF-CLIMB SPEED (V_{XSE})

V_{XSE} is used only to clear obstructions during initial climb-out as it gives the greatest altitude gain per unit of horizontal distance. It provides less engine cooling and requires more rudder control input than V_{YSE} .

SINGLE ENGINE SERVICE CEILING

The single engine service ceiling is the maximum altitude at which an airplane will climb at a rate of at least 50 feet per minute in smooth air, with one engine inoperative.

The single engine service ceiling chart should be used during flight planning to determine whether the airplane, as loaded, can maintain the Minimum En Route Altitude (MEA) if IFR, or terrain clearance if VFR, following an engine failure.

BASIC SINGLE ENGINE PROCEDURES

Know and follow, to the letter, the single-engine emergency procedures specified in your Pilot's Operating Handbook and FAA Approved Airplane Flight Manual for your specific make and model airplane. However, the basic fundamentals of all the procedures are as follows:

1. Maintain airplane control and airspeed at all times.
THIS IS CARDINAL RULE NUMBER ONE.
2. Usually, apply maximum power to the operating engine.

However, if the engine failure occurs at a speed below V_{MCA} , during cruise or in a steep turn, you may elect to use only enough power to maintain a safe speed and altitude. If the failure occurs on final approach, use power only as necessary to complete the landing.

3. Reduce drag to an absolute minimum.
4. Secure the failed engine and related sub-systems.

The first three steps should be done promptly and from memory. The check list should then be consulted to be sure that the inoperative engine is secured properly and that the appropriate switches are placed in the correct position. The airplane must be banked about 5° into the operating engine, with the "slip/skid" ball slightly out of center toward the operating engine, to achieve rated performance.

Another note of caution: Be sure to identify the dead engine, positively, before securing it. Remember: First identify the suspected engine (i.e., "Dead foot means dead engine"), second, verify with cautious throttle movement, then secure.

ENGINE FAILURE ON TAKEOFF

If an engine fails before attaining lift-off speed or below V_{MCA} , the only proper action is to discontinue the takeoff. If the engine fails after lift-off with the landing gear still down, the takeoff should still be discontinued if touchdown and roll-out on the remaining runway is still possible.

If you do find yourself in a position of not being able to climb, it is much better to reduce the power on the good engine and land straight ahead than try to force a climb and lose control.

Your Pilot's Operating Handbook and FAA Approved Airplane Flight Manual contains charts that are used in calculating the runway length required to stop if the engine fails

before reaching lift-off speed and also has charts showing the single-engine performance after lift-off.

Study your charts carefully. No airplane is capable of climbing out on one engine under all weight, pressure altitude, and temperature conditions. Know, before you take the actual runway, whether you can maintain control and climb out if you lose an engine while the gear is still down. It may be necessary to off-load some weight, or wait for more favorable temperatures.

WHEN TO FLY V_X , V_Y , V_{XSE} AND V_{YSE}

During normal two-engine operations, always fly V_Y (V_X if necessary for obstacle clearance) on initial climb out. Then, accelerate to your cruise climb airspeed, which may be V_Y plus 10 or 15 knots after you have obtained a safe altitude. Use of cruise climb airspeed will give you better engine cooling, increased inflight visibility and better fuel economy. However, at first indication of an engine failure during climb out, or while on approach, establish V_{YSE} or V_{XSE} , whichever is appropriate. (Consult your Pilot's Operating Handbook and FAA Approved Airplane Flight Manual for specifics.)

STALLS, SLOW FLIGHT AND TRAINING

The stall warning system must be kept operational at all times and must not be deactivated by interruption of circuits, circuit breakers, or fuses. Compliance with this requirement is especially important in all high performance multi-engine airplanes during engine-out practice or stall demonstrations, because the stall speed is critical in all low speed operations of high-performance airplanes.

Training should be accomplished under the supervision of a qualified instructor-pilot, with careful reference to the applicable sections of the FAA Practical Test Standards and FAA Pilot Transition Courses for Complex Single Engine and

Light Twin Engine Airplanes (AC61-9B). In particular, observe carefully the warnings in the Practical Test Standards.

The single-engine stall speed of a twin-engine airplane is generally slightly below the power off (engines idle) stall speed, for a given weight condition. Single-engine stalls should not be conducted in multi-engine airplanes by other than qualified engineering test pilots.

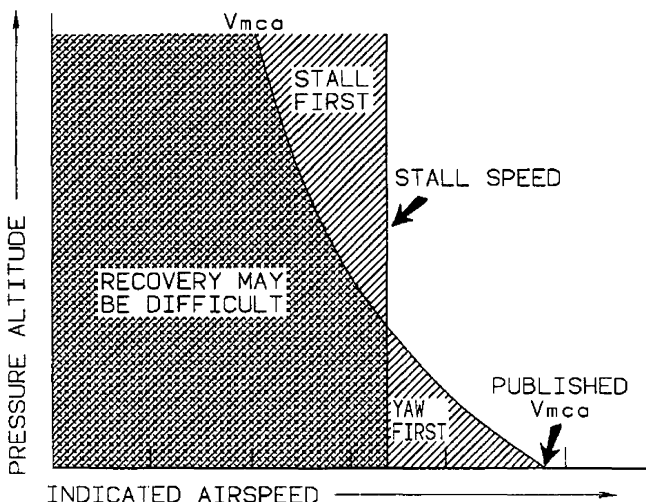

RELATIONSHIP BETWEEN STALL SPEED AND V_{mca} FOR AIRCRAFT WITH NORMALLY ASPIRATED ENGINES.

C93TH00C0104 C

Engine-out minimum control speed generally decreases with altitude, while the single engine stall speed remains approximately constant for normally aspirated engines. No such demonstration should be attempted when the altitude and temperature are such that the engine-out minimum control

speed is known, or discovered to be, close to the stalling speed. Loss of directional or lateral control, just as a stall occurs, is potentially hazardous.

V_{SSE} , the airspeed below which an engine should not be intentionally rendered inoperative for practice purposes, was established because of the apparent practice of some pilots, instructors, and examiners, of intentionally rendering an engine inoperative at a time when the airplane is being operated at a speed close to, or below the power-idle stall speed. Unless the pilot takes immediate and proper corrective action under such circumstances, it is possible to enter an inadvertent spin.

It is recognized that flight below V_{SSE} with one engine inoperative, or simulated inoperative, may be required for conditions such as practice demonstration of V_{MCA} for multi-engine pilot certification. Refer to the procedure set forth in the Pilot's Operating Handbook and FAA Approved Airplane Flight Manual for your airplane. This procedure calls for simulating one engine inoperative by reducing the power level (throttle) on one engine to idle while operating at an airspeed above V_{SSE} . Power on the other engine is set at maximum, then airspeed is reduced at approximately one knot per second until either V_{MCA} or stall warning is obtained. During this transition, rudder should be used to maintain directional control, and ailerons should be used to maintain a 5° bank toward the operative engine. At the first sign of either V_{MCA} or stall warning (which may be evidenced by inability to maintain longitudinal, lateral or directional control, aerodynamic stall buffet, or stall warning horn sound), recovery must be initiated immediately by reducing power to idle on operative engine and lowering the nose to regain V_{SSE} . Resume normal flight. This entire procedure should be used at a safe altitude of at least 5,000 feet above the ground in clear air only.

If stall warning is detected prior to the first sign of V_{MCA} , an engine-out minimum control speed demonstration cannot be

accomplished under the existing gross weight conditions and should not be attempted.

SPINS

A major cause of fatal accidents in general aviation airplanes is a spin. Stall demonstrations and practice are a means for a pilot to acquire the skills to recognize when a stall is about to occur and to recover as soon as the first signs of a stall are evident.

If a stall does not occur - A spin cannot occur. It is important to remember however, that a stall can occur in any flight attitude, at any airspeed, if controls are misused.

Unless your airplane has been specifically certificated in the aerobatic category and specifically tested for spin recovery characteristics, it is placarded against intentional spins. The pilot of an airplane placarded against intentional spins should assume that the airplane may become uncontrollable in a spin, since its performance characteristics beyond certain limits specified in the FAA regulations may not have been tested and are unknown. This is why airplanes are placarded against intentional spins, and this is why stall avoidance is your protection against an inadvertent spin.

Pilots are taught that intentional spins are entered by deliberately inducing a yawing moment with the controls as the airplane is stalled. Inadvertent spins result from the same combination - stall plus yaw. That is why it is important to use coordinated controls and to recover at the first indication of a stall when practicing stalls.

In any twin engine airplane, fundamental aerodynamics dictate that if the airplane is allowed to become fully stalled while one engine is providing lift-producing thrust, the yawing moment which can induce a spin will be present. Consequently, it is important to immediately reduce power on the operating engine, lower the nose to reduce the angle of attack, and increase the airspeed to recover from the stall.

In any twin engine airplane, if application of stall recovery controls is delayed, a rapid rolling and yawing motion may develop, even against full aileron and rudder, resulting in the airplane becoming inverted during the onset of a spinning motion. Once the airplane has been permitted to progress beyond the stall and is allowed to reach the rapid rolling and yawing condition, the pilot must then immediately initiate the generally accepted spin recovery procedure for multi-engine airplanes, which is as follows:

Immediately move the control column full forward, apply full rudder opposite to the direction of the spin and reduce power on both engines to idle. These three actions should be done as near simultaneously as possible; then continue to hold this control position until rotation stops, then neutralize all controls and execute a smooth pullout. Ailerons should be neutral during recovery. **THE LONGER THE PILOT DELAYS BEFORE TAKING CORRECTIVE ACTION, THE MORE DIFFICULT RECOVERY WILL BECOME.**

Always remember that extra alertness and pilot techniques are required for slow flight maneuvers, including the practice or demonstration of stalls or V_{MCA} . In addition to the foregoing mandatory procedure, always:

- Be certain that the center of gravity of the airplane is as far forward as possible. Forward C.G. aids stall recovery, spin avoidance and spin recovery. An aft C.G. can create a tendency for a spin to stabilize, which delays recovery.
- Whenever a student pilot will be required to practice slow flight or single-engine maneuvers, be certain that the qualified instructor pilot has a full set of operable controls available. FAA regulations prohibit flight instruction without full dual controls.
- Conduct any maneuvers which could possibly result in a spin at altitudes in excess of five thousand (5,000) feet above ground level in clear air only.

- Remember that an airplane, at or near traffic pattern and approach altitudes, cannot recover from a spin, or perhaps even a stall, before impact with the ground. For twin engine airplanes, when descending to traffic altitude and during pattern entry and all other flight operations, maintain speed no lower than $V_{SS\bar{E}}$. On final final approach maintain at least the airspeed shown in the flight manual. Should a go-around be required, do not apply more power than necessary until the airplane has accelerated to $V_{SS\bar{E}}$. Recognize that under some conditions of weight, density altitude, and airplane configuration, a twin engine airplane cannot climb or accelerate on a single engine. Hence a single engine go-around is impossible and the airplane is committed to a landing. Plan your approach accordingly.
- Remember that if an airplane flown under instrument conditions is permitted to stall or enter a spin, the pilot, without reference to the horizon, is certain to become disoriented. He may be unable to recognize a stall, spin entry, or the spin condition and he may be unable to determine even the direction of the rotation.
- Finally, never forget that stall avoidance is your best protection against an inadvertent spin. **MAINTAIN YOUR AIRSPEED.**

DESCENT

In twin engine piston-powered airplanes, supercharged or normally aspirated, it is necessary to avoid prolonged descents with low power, as this produces two problems: (1) excessively cool cylinder head temperatures which cause premature engine wear, and (2) excessively rich mixtures due to idle enrichment (and altitude) which causes soot and lead deposits on the spark plugs (fouling). The second of these is the more serious consideration; the engine may not respond to the throttle when it is desired to discontinue the descent. Both problems are amenable to one solution: maintain adequate power to keep cylinder head temperatures in

the "green" range during descent, and lean to best power mixture (that is, progressively enrich the mixture from cruise only slightly as altitude decreases). This procedure will lengthen the descent, of course, and requires some advance planning. If it is necessary to make a prolonged descent at or near idle, as in practicing forced landings, at least avoid the problem of fouled spark plugs by frequently advancing the throttle until the engine runs smoothly, and maintain an appropriate mixture setting with altitude. (Refer to pre-landing check list.)

VORTICES - WAKE TURBULENCE

Every airplane generates wakes of turbulence while in flight. Part of this is from the propeller or jet engine, and part from the wing tip vortices. The larger and heavier the airplane, the more pronounced and turbulent the wakes will be. Wing tip vortices from large, heavy airplanes are very severe at close range, degenerating with time, wind and distance. These are rolling in nature, from each wing tip. In tests, vortex velocities of 133 knots have been recorded. Encountering the rolling effect of wing tip vortices within two minutes after passage of large airplanes is most hazardous to light airplanes. This roll effect can exceed the maximum counter-roll obtainable in a light airplane. The turbulent areas may remain for as long as three minutes or more, depending on wind conditions, and may extend several miles behind the airplane. Plan to fly slightly above and to the windward side of other airplanes. Because of the wide variety of conditions that can be encountered, there is no set rule to follow to avoid wake turbulence in all situations. However, the Airman's Information Manual, and to a greater extent Advisory Circular 90-23, Aircraft Wake Turbulence, provide a thorough discussion of the factors you should be aware of when wake turbulence may be encountered.

TAKEOFF AND LANDING CONDITIONS

When taking off on runways covered with water or freezing slush, the landing gear should remain extended for approximately ten seconds longer than normal, allowing the wheels to spin and dissipate the freezing moisture. The landing gear should then be cycled up, then down, wait approximately five seconds and then retracted again. Caution must be exercised to insure that the entire operation is performed below Maximum Landing Gear Operating Airspeed.

Use caution when landing on runways that are covered by water or slush which cause hydroplaning (aquaplaning), a phenomenon that renders braking and steering ineffective because of the lack of sufficient surface friction. Snow and ice covered runways are also hazardous. The pilot should also be alert to the possibility of the brakes freezing.

Use caution when taking off or landing during gusty wind conditions. Also be aware of the special wind conditions caused by buildings or other obstructions located near the runway.

MEDICAL FACTS FOR PILOTS

GENERAL

When the pilot enters the airplane, he becomes an integral part of the man-machine system. He is just as essential to a successful flight as the control surfaces. To ignore the pilot in preflight planning would be as senseless as failing to inspect the integrity of the control surfaces or any other vital part of the machine. The pilot has the responsibility for determining his reliability prior to entering the airplane for flight. When piloting an airplane, an individual should be free of conditions which are harmful to alertness, ability to make correct decisions, and rapid reaction time.

FATIGUE

Fatigue generally slows reaction time and causes errors due to inattention. In addition to the most common cause of fatigue; insufficient rest and loss of sleep, the pressures of business, financial worries, and family problems can be important contributing factors. If you are tired, don't fly.

HYPOXIA

Hypoxia, in simple terms, is a lack of sufficient oxygen to keep the brain and other body tissues functioning properly. There is a wide individual variation in susceptibility to hypoxia. In addition to progressively insufficient oxygen at higher altitudes, anything interfering with the blood's ability to carry oxygen can contribute to hypoxia (anemias, carbon monoxide, and certain drugs). Also, alcohol and various drugs decrease the brain's tolerance to hypoxia.

Your body has no built-in alarm system to let you know when you are not getting enough oxygen. It is impossible to predict when or where hypoxia will occur during a given flight, or how it will manifest itself. Some of the common symptoms of hypoxia are increased breathing rate, a light-headed or dizzy sensation, tingling or warm sensation, sweating, reduced visual field, sleepiness, blue coloring of skin, fingernails, and lips, and behavior changes. A particularly dangerous feature of hypoxia is an increased sense of well-being, called euphoria. It obscures a person's ability and desire to be critical of himself, slows reaction time, and impairs thinking ability. Consequently, a hypoxic individual commonly believes things are getting progressively better while he nears total collapse.

The symptoms are slow but progressive, insidious in onset, and are most marked at altitudes starting above ten thousand feet. Night vision, however, can be impaired starting at an altitude of 5,000 feet. Persons who have recently overindulged in alcohol, who are moderate to heavy smokers, or

who take certain drugs, may be more susceptible to hypoxia. Susceptibility may also vary in the same individual from day to day or even morning to evening. Use oxygen on flights above 10,000 feet and at any time when symptoms appear.

Depending upon altitude, a hypoxic individual has a limited time to make decisions and perform useful acts, even though he may remain conscious for a longer period. If pressurization equipment fails at certain altitudes the pilot and passengers have only a certain amount of time to get an oxygen mask on before they exceed their time of useful consciousness. The time of useful consciousness is approximately 3-5 minutes at 25,000 feet of altitude for the average individual and diminishes markedly as altitude increases. At 30,000 feet altitude, for example, the time of useful consciousness is approximately 1-2 minutes. Therefore, in the event of depressurization, oxygen masks should be used immediately.

Should symptoms occur that cannot definitely be identified as either hypoxia or hyperventilation, try three or four deep breaths of oxygen. The symptoms should improve markedly if the condition was hypoxia (recovery from hypoxia is rapid).

Pilots who fly to altitudes that require or may require the use of supplemental oxygen should be thoroughly familiar with the operation of the airplane oxygen systems. A preflight inspection of the system should be performed, including proper fit of the mask. The passengers should be briefed on the proper use of their oxygen system before flight.

Pilots who wear beards should be careful to ensure that their beard is carefully trimmed so that it will not interfere with proper sealing of the oxygen masks. If you wear a beard or moustache, test the fit of your oxygen mask on the ground for proper sealing. Studies conducted by the military and oxygen equipment manufacturers conclude that oxygen masks do not seal over beards or heavy facial hair.

Federal Aviation Regulations related to the use of supplemental oxygen by flight crew and passengers must be adhered to if flight to higher altitudes is to be accomplished safely. Passengers with significant circulatory or lung disease may need to use supplemental oxygen at lower altitudes than specified by these regulations.

Pilots of pressurized airplanes should receive physiological training with emphasis on hypoxia and the use of oxygen and oxygen systems. Pilots of airplanes with pressure demand oxygen systems should undergo training, experience altitude chamber decompression, and be familiar with pressure breathing before flying at high altitude. This training is available throughout the United States at nominal cost. Information regarding this training may be obtained by request from the Chief, Civil Aeromedical Institute, Attention: Aeromedical Education Branch, AAC-140, Mike Monroney Aeronautical Center, P. O. Box 25082, Oklahoma City, Oklahoma 73125

HYPERVENTILATION

Hyperventilation, or overbreathing, is a disturbance of respiration that may occur in individuals as a result of emotional tension or anxiety. Under conditions of emotional stress, fright, or pain, breathing rate may increase, causing increased lung ventilation, although the carbon dioxide output of the body cells does not increase. As a result, carbon dioxide is "washed out" of the blood. The most common symptoms of hyperventilation are: dizziness, nausea, sleepiness, and finally, unconsciousness. If the symptoms persist discontinue use of oxygen and consciously slow your breathing rate until symptoms clear, and then resume normal breathing rate. Normal breathing can be aided by talking aloud.

ALCOHOL

Common sense and scientific evidence dictate that you must not fly as a crew member while under the influence of alcohol. Alcohol, even in small amounts, produces (among other things):

- A dulling of critical judgement.
- A decreased sense of responsibility.
- Diminished skill reactions and coordination.
- Decreased speed and strength of muscular reflexes (even after one ounce of alcohol).
- Decreases in efficiency of eye movements during reading (after one ounce of alcohol).
- Increased frequency of errors (after one ounce of alcohol).
- Constriction of visual fields.
- Decreased ability to see under dim illuminations.
- Loss of efficiency of sense of touch.
- Decrease of memory and reasoning ability.
- Increased susceptibility to fatigue and decreased attention span.
- Decreased relevance of response.
- Increased self confidence with decreased insight into immediate capabilities.

Tests have shown that pilots commit major errors of judgment and procedure at blood alcohol levels substantially less than the minimum legal levels of intoxication for most states. These tests further show a continuation of impairment from alcohol up to as many as 14 hours after consumption, with no appreciable diminution of impairment. The body metabolizes ingested alcohol at a rate of about one-third of an ounce per hour. Even after the body completely

destroys a moderate amount of alcohol, a pilot can still be severely impaired for many hours by hangover. The effects of alcohol on the body are magnified at altitudes, as 2 oz. of alcohol at 18,000 feet produce the same adverse effects as 6 oz. at sea level.

Federal Aviation Regulations have been amended to reflect the FAA's growing concern with the effects of alcohol impairment. FAR 91 states:

"Alcohol or drugs.

(a) No person may act or attempt to act as a crew-member of a civil aircraft -

(1) Within 8 hours after the consumption of any alcoholic beverage;

(2) While under the influence of alcohol;

(3) While using any drug that affects the person's faculties in any way contrary to safety; or

(4) While having .04 percent by weight or more alcohol in the blood.

(b) Except in an emergency, no pilot of a civil aircraft may allow a person who appears to be intoxicated or who demonstrates by manner or physical indications that the individual is under the influence of drugs (except a medical patient under proper care) to be carried in that aircraft."

Because of the slow destruction of alcohol by the body, a pilot may still be under influence eight hours after drinking a moderate amount of alcohol. Therefore, an excellent rule is to allow at least 12 to 24 hours between "bottle and throttle," depending on the amount of alcoholic beverage consumed.

DRUGS

Self-medication or taking medicine in any form when you are flying can be extremely hazardous. Even simple home or

over-the-counter remedies and drugs such as aspirin, anti-histamines, cold tablets, cough mixtures, laxatives, tranquilizers, and appetite suppressors, may seriously impair the judgment and coordination needed while flying. The safest rule is to take no medicine before or while flying, except after consultation with your Aviation Medical Examiner.

SCUBA DIVING

Flying shortly after any prolonged scuba diving could be dangerous. Under the increased pressure of the water, excess nitrogen is absorbed into your system. If sufficient time has not elapsed prior to takeoff for your system to rid itself of this excess gas, you may experience the bends at altitudes even under 10,000 feet, where most light planes fly.

CARBON MONOXIDE AND NIGHT VISION

The presence of carbon monoxide results in hypoxia which will affect night vision in the same manner and extent as hypoxia from high altitudes. Even small levels of carbon monoxide have the same effect as an altitude increase of 8,000 to 10,000 feet. Smoking several cigarettes can result in a carbon monoxide saturation sufficient to affect visual sensitivity equal to an increase of 8,000 feet altitude.

DECOMPRESSION SICKNESS

Pilots flying unpressurized airplanes at altitudes in excess of 10,000 feet should be alert for the symptoms of 'decompression sickness'. This phenomenon, while rare, can impair the pilot's ability to perform and in extreme cases, can result in the victim being rendered unconscious. Decompression sickness, also known as dysbarism and aviator's "bends", is caused by nitrogen bubble formation in body tissue as the ambient air pressure is reduced by climbing to higher altitudes. The symptoms are pain in the joints, abdominal cramps, burning sensations in the skin, visual impairment

Section X
Safety Information

Beechcraft
Twin Engine (Piston)

and numbness. Some of these symptoms are similar to hypoxia. The only known remedy for decompression sickness is recompression, which can only be accomplished in an unpressurized airplane by descending. The pilot should immediately descend if it is suspected that this condition exists, since the effects will only worsen with continued exposure to the reduced pressure environment at altitude and could result, if uncorrected, in complete incapacitation. The possibility of decompression sickness can be greatly reduced by pre-breathing oxygen prior to flight and by commencing oxygen breathing well below the altitudes where it is legally mandatory.

A FINAL WORD

Airplanes are truly remarkable machines. They enable us to shrink distance and time, and to expand our business and personal horizons in ways that, not too many years ago, were virtually inconceivable. For many businesses, the general aviation airplane has become the indispensable tool of efficiency.

Advances in the mechanical reliability of the airplanes we fly have been equally impressive, as attested by the steadily declining statistics of accidents attributed to mechanical causes, at a time when the airframe, systems and power plants have grown infinitely more complex. The explosion in capability of avionics systems is even more remarkable. Radar, RNAV, LORAN, sophisticated autopilots and other devices which, just a few years ago, were too large and prohibitively expensive for general aviation size airplanes, are becoming increasingly commonplace in even the smallest airplanes.

It is thus that this Safety Information is directed to the pilot, for it is in the area of the skill and proficiency of you, the pilot, that the greatest gains in safe flying are to be made over the years to come. Intimate knowledge of your airplane, its capabilities and its limitations, and disciplined adherence to the procedures for your airplane's operation, will enable you to transform potential tragedy into an interesting hangar story when - as it inevitably will - the abnormal situation is presented.

Know your airplane's limitations, and your own. Never exceed either.

Safe flying,

BEECH AIRCRAFT CORPORATION

**THIS PAGE INTENTIONALLY LEFT
BLANK**